



Tel: +90-216 466 84 60
Fax: +90-216 364 65 65
datakom@datakom.com.tr
<http://www.datakom.com.tr>

Rainbow Scada User Guide V-3.5	
Written By:	Tugay Okatan
Date:	03-07-2017
Issue	02

TABLE OF CONTENTS

Section

- 1. INTRODUCTION**
- 2. MANAGER ACCOUNT LOGIN**
 - 2.1. CREATE NEW USER**
 - 2.1.1. Edit User Roles**
 - 2.1.2. Create Nodes**
 - 2.1.3. Add Device**
- 3. MONITORING ACCOUNT LOGIN**
 - 3.1. OVERVIEW**
 - 3.2. MENU**
 - 3.2.1. Show Device Position**
 - 3.2.2. Show Device Values**
 - 3.2.3. Show Device Analysis**
 - 3.2.4. Show Device Options**
 - 3.2.5. Move Device to Position**
- 4. TOOLS**
 - 4.1. Tool**
 - 4.1.1. Change Password**
 - 4.1.2. Search by Engine Serial Number**
 - 4.1.3. Device Statistics**
 - 4.1.4. Device Inventory**
 - 4.1.5. Toggle Icon Filter**
 - 4.1.6. Toggle Population**
 - 4.1.7. Toggle Alarm Table**
 - 4.2. Report**
 - 4.2.1. Meter Report**
 - 4.2.2. Power Display**
 - 4.2.3. Alarm Display**
 - 4.2.4. General Report**
 - 4.2.5. User Logs**
 - 4.2.6. Device Logs**
 - 4.2.7. Early Warning**
 - 4.3. Language Selection**
- 5. CONFIG SCADA**
 - 5.1. Overview**
 - 5.2. Config Scada Login**
 - 5.3. Config Mode**
 - 5.3.1. Config Mode Enable**
 - 5.3.2. Logo Upload**
 - 5.3.3. Create Header**
 - 5.3.4. Change Background Color**
 - 5.3.5. Save Changes**
 - 5.3.6. Add New Tab**
 - 5.3.7. Rename Tab**
 - 5.3.8. Remove Tab**
 - 5.3.9. Add Background Image**
 - 5.3.10. Add Icon**

- 5.3.11. Measurement Values**
 - 5.3.11.1. Add Measurement Values**
 - 5.3.11.2. Create Gauge**
 - 5.3.11.3. Display Settings of Measurement Values**
- 5.3.12. Add Object**
- 5.3.13. Object Handling**
- 5.3.14. Remove Object**
- 5.3.15. Object Types**
 - 5.3.15.1. Energy Interruption Object**
 - 5.3.15.2. Daily kWh Object**
 - 5.3.15.3. Arithmetic Object**
 - 5.3.15.4. Consumption Object**
 - 5.3.15.5. Multiple Value Chart Object**
 - 5.3.15.6. Table Object**
- 5.3.16. Config Mode Disable**
- 5.3.17. Sample Projects**

1.INTRODUCTION

Rainbow Scada is an internet based, multi-functional remote monitoring system which supports all Datakom products and third party products like energy meters and industrial controllers.

You will need a username and password to login to the monitoring system. Please contact Datakom technical support team at below address for any additional support to this document.

technical.support@datakom.com.tr

2.MANAGER ACCOUNT LOGIN

Click on the below link to connect to Rainbow Scada

<http://rm.datakom.com.tr/>

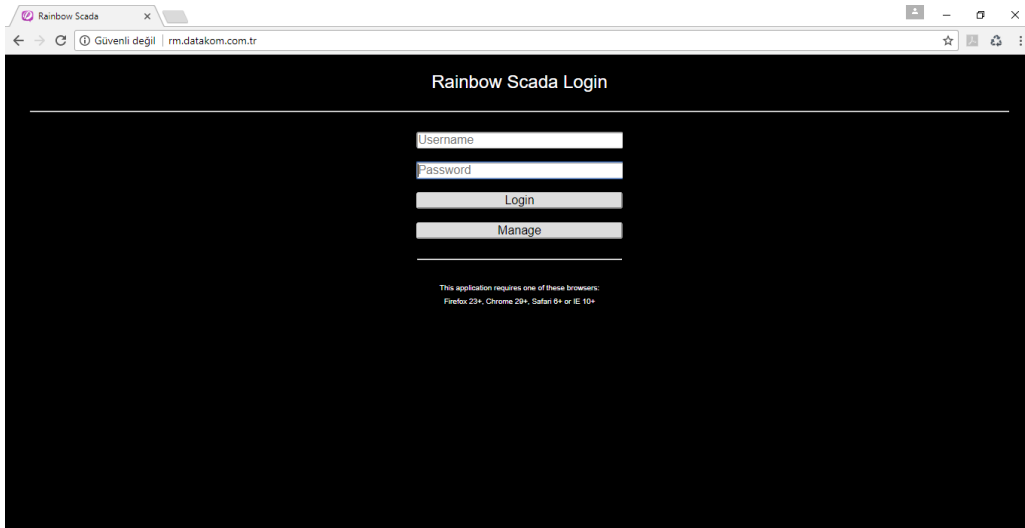

Rainbow Scada application requires Firefox 23+, Chrome 29+, Safari 6+ or IE 10+

If you have a manager account, enter your username/password and click **Manage** button.

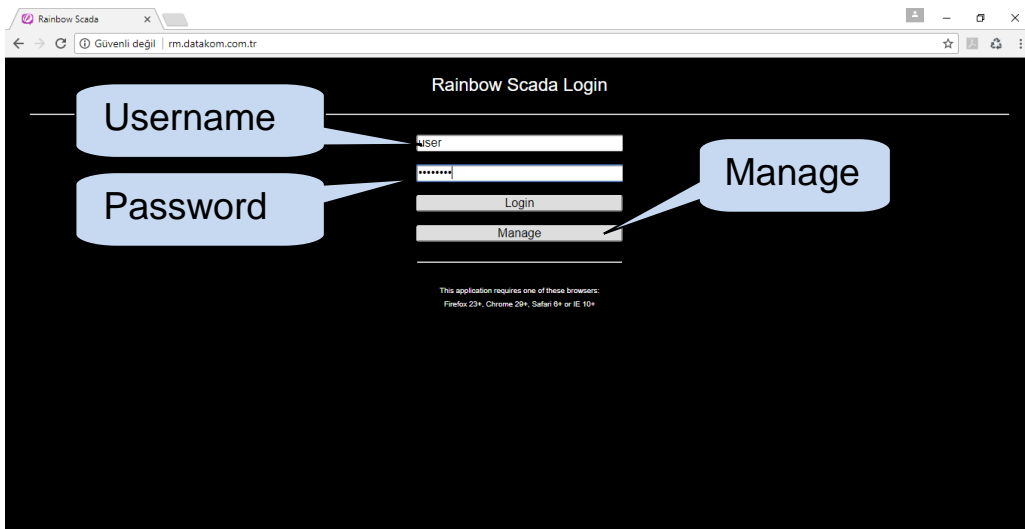

If this is not a manager account, the system will automatically login to the monitoring page even when you click the **Manage** button.

The “**About**” screen will open, click button to continue.

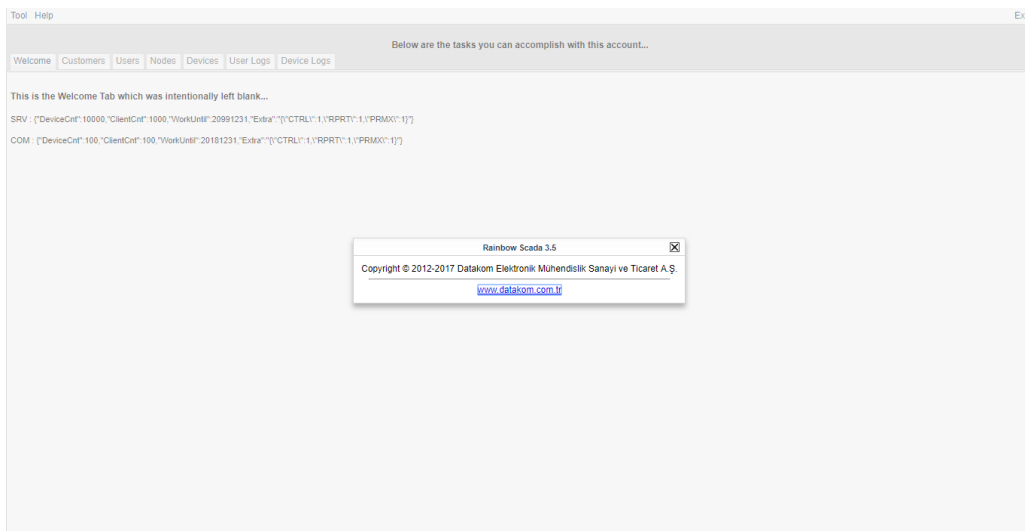

The main page is the Welcome page which is intentionally left blank.

The Line starting with COM displays information about Device Count, Client Count, and Expiration Date.

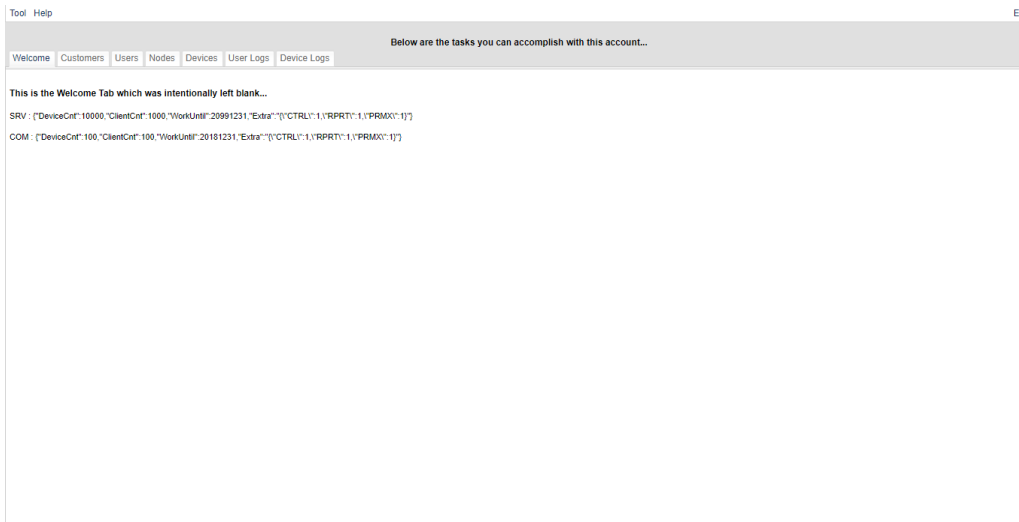

Click **Customers** tab, you will display your account settings.

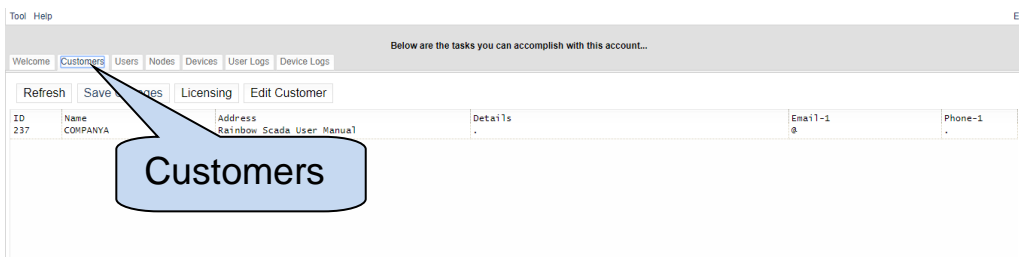

Configure Name, Address, Details, E-mail and Phone.

Name: Customer name.

Address: Customer address.

Details: Detailed info about the account can be written in this section.

E-mail-1, E-mail-2: E-mail addresses can be written in this section.

Phone-1, Phone-2: Phone numbers can be written in this section.

Press enter button, system will warn to save the changes.

Click **Save Changes** tab.

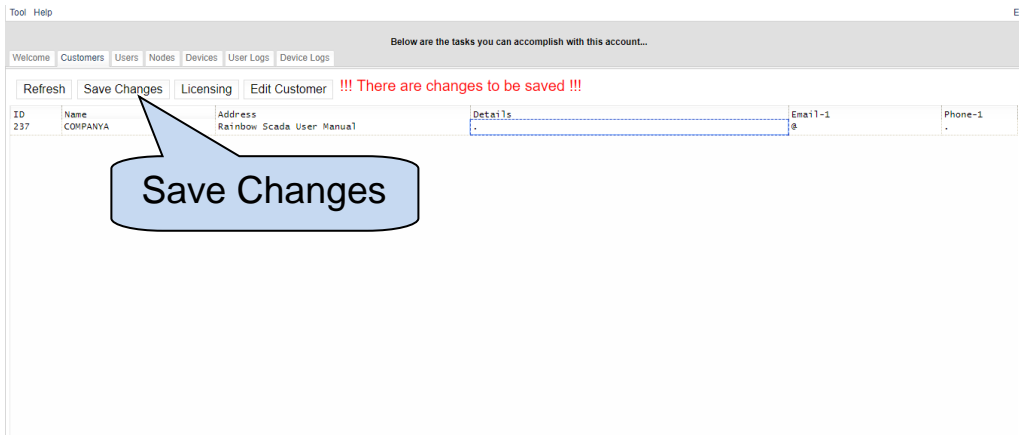

Click on **customer** and click **Licensing** tab to view license details.

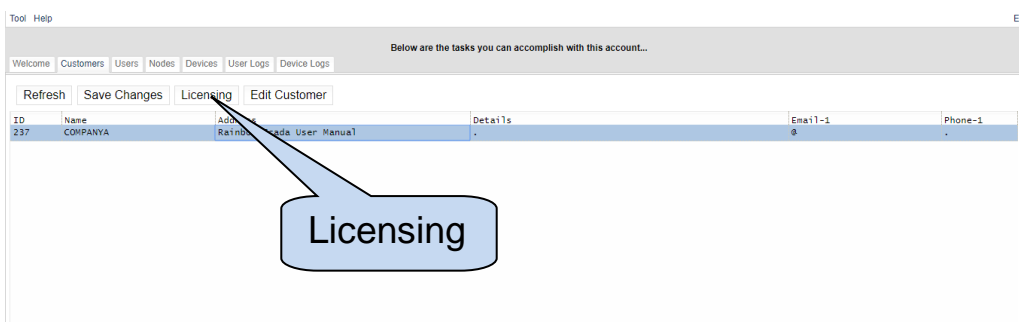

Customer Licene information will be displayed.

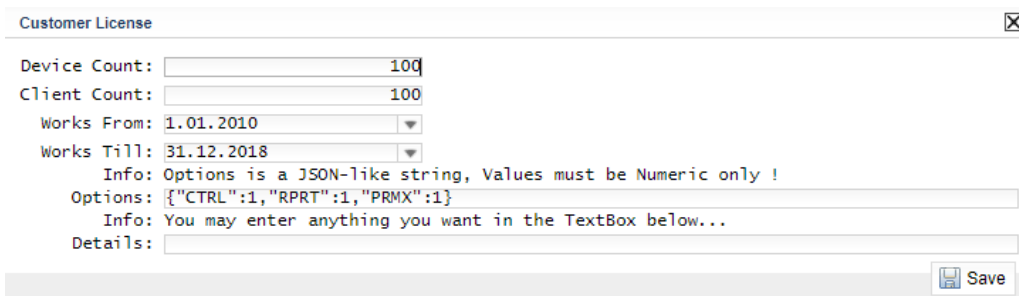

Device Count: This is the maximum number of devices that this account is allowed to monitor.

Client Count: This is the maximum number of sub_users that can be created under this account.

Works From-Work Till: This is the time interval of license activation.

Options: These are the customer roles.

"CTRL":1= Account will have the ability to control devices.

"RPRT":1= Account will have the ability to analyze and to report.

"PRMX":1= Account will have the ability to edit parameters.

If you click on **Save** button, the system will warn you to contact the service provider.

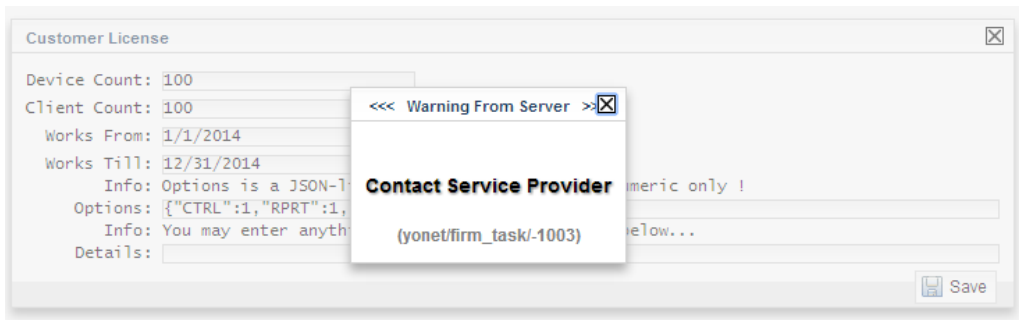

 **Licensing can be only provided by Datakom.**

Click **refresh** tab to refresh the page.

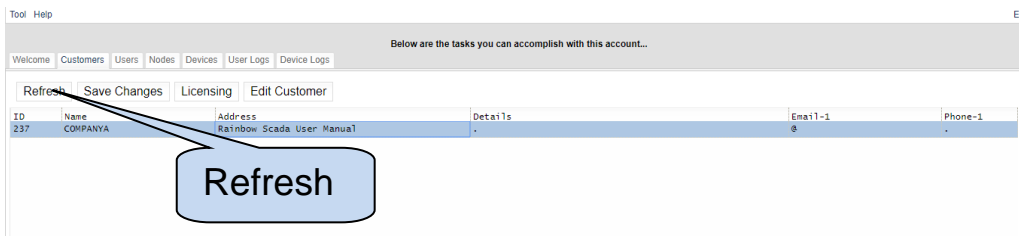

Click **Users** tab to display all users under this customer account.

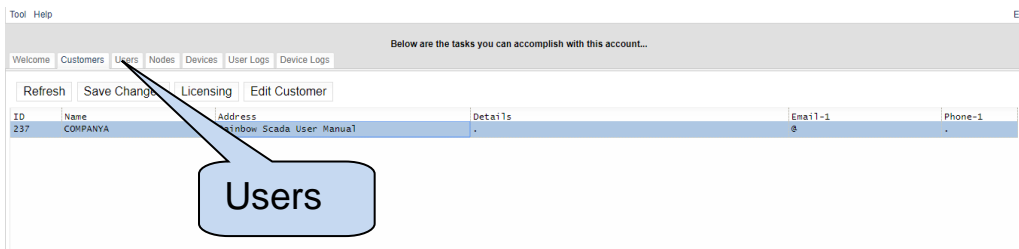

2.1.CREATE NEW USER

Click **New User** tab;

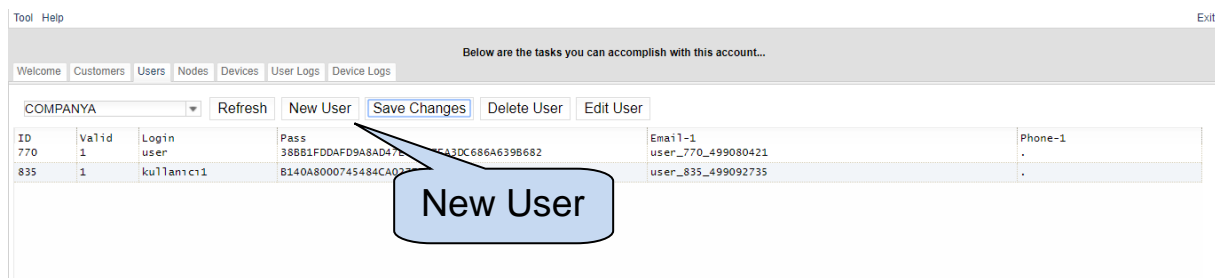

A new user row will be created.

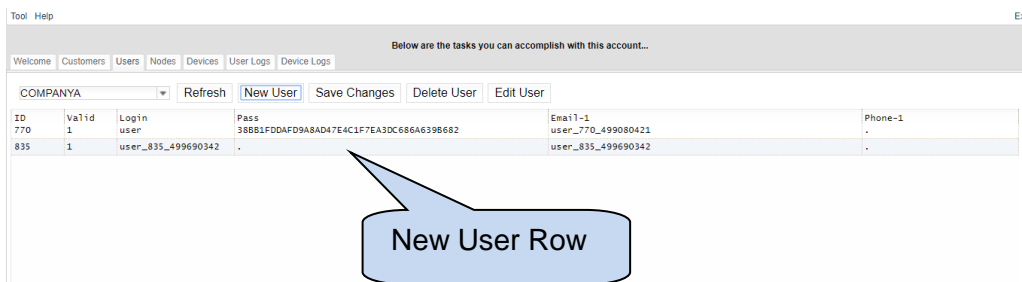

Double click **Login**, enter login name and then press enter button.

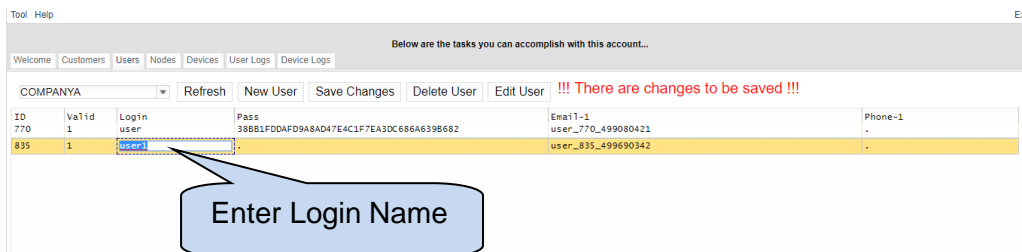

Double click **Pass**, enter password and then press enter button.

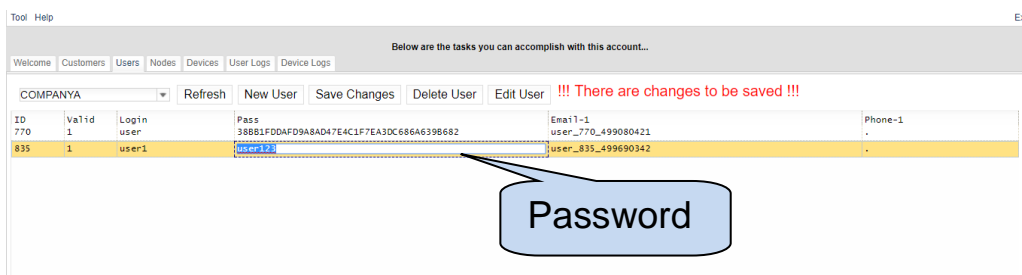

 Only an encrypted form of the password is displayed !

Double click **Email-1**, **Phone-1** to enter email address / phone numbers and then press enter button.

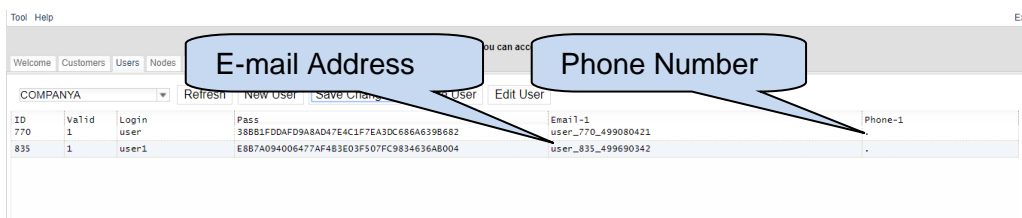

The system will warn to save the changes.

Click **Save Changes** tab.

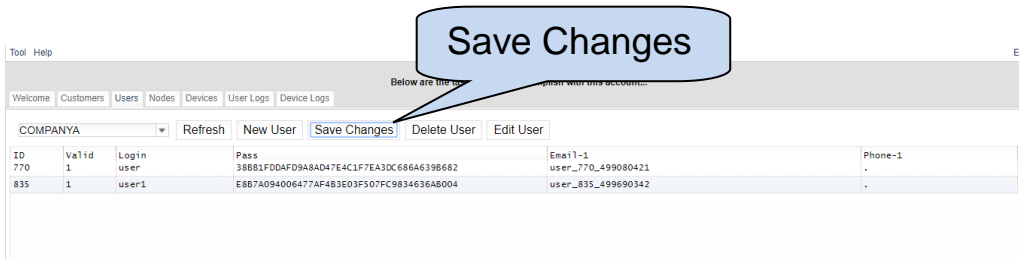

 **The password must be at least 8 characters long.**

2.1.1. Edit User Roles

User accounts may have different roles. A basic user account will have permission to do monitoring only.

To edit user roles; click user's row and then select **Edit User**.

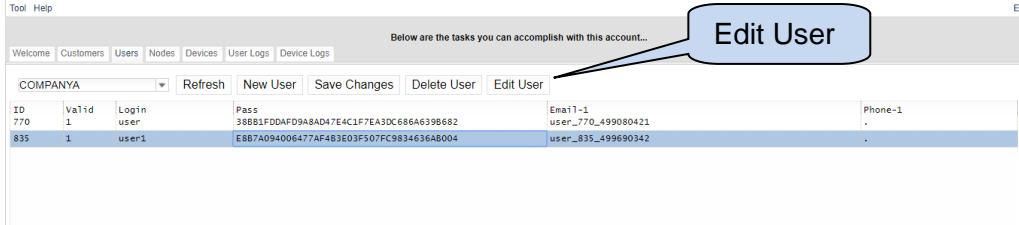

Available User Roles will be displayed.

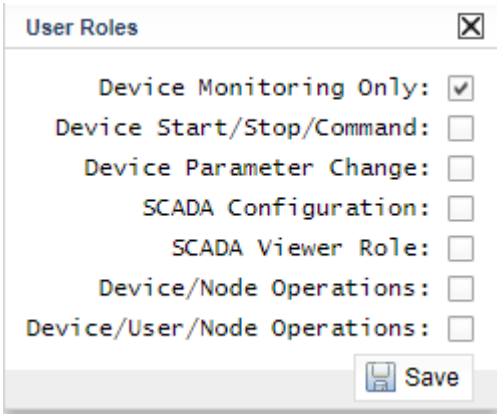

Device Monitoring Only: This feature must always be selected. Otherwise, user can not login monitoring.

Device Start/Stop/Command: If this feature is selected, user can control devices remotely.

Device Parameter Change: Kullanıcı, uzaktan izleme hesabında ekli olan cihazların parametrelerini değiştirebilir.

SCADA Configuration: User can use SCADA Configuration feature.

SCADA Viewer Role: User can monitor the remote monitoring screen prepared by SCADA Configuration feature.

Device / User / Node Operations: If this feature is selected, the user will have permission to manage the account.

Click **Save** button to save changes.

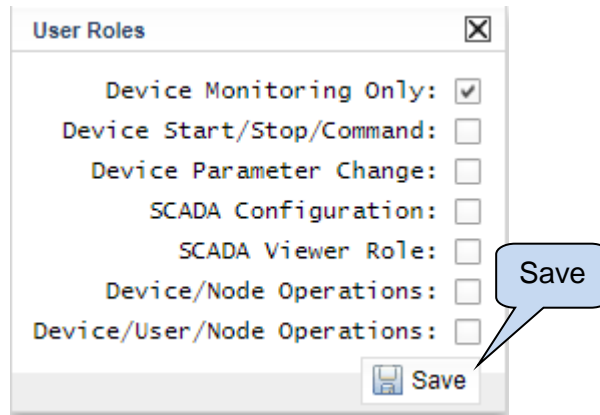

To delete one of the user accounts, select the user row and then click **Delete User**.

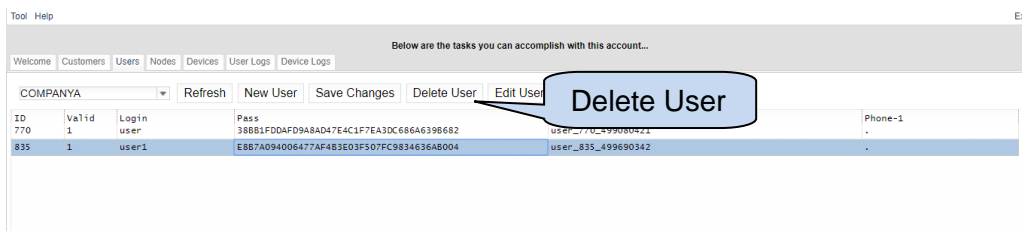

2.1.2. Create Nodes

To create nodes for the existing accounts, click **Nodes**.

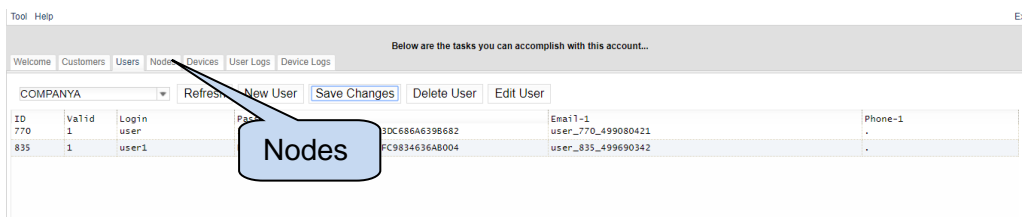

On this page, nodes can be created and linked to user's accounts.

Root Node is the main node and sub-nodes can be created under this main node.

To create a root node, click on **Create RootNode**.

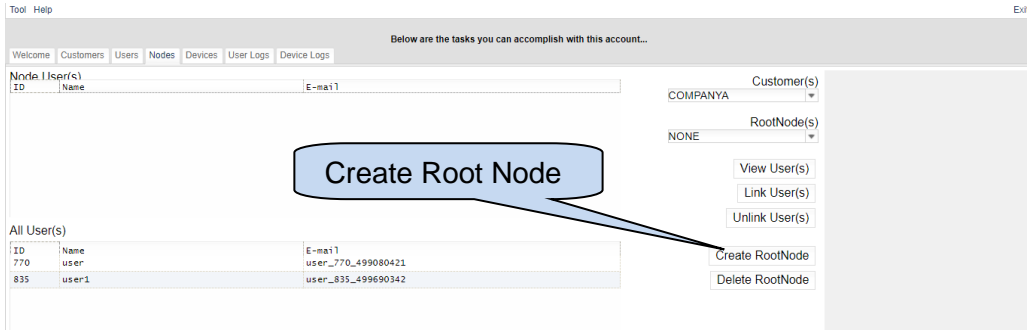

Write a name and then click **Save**.

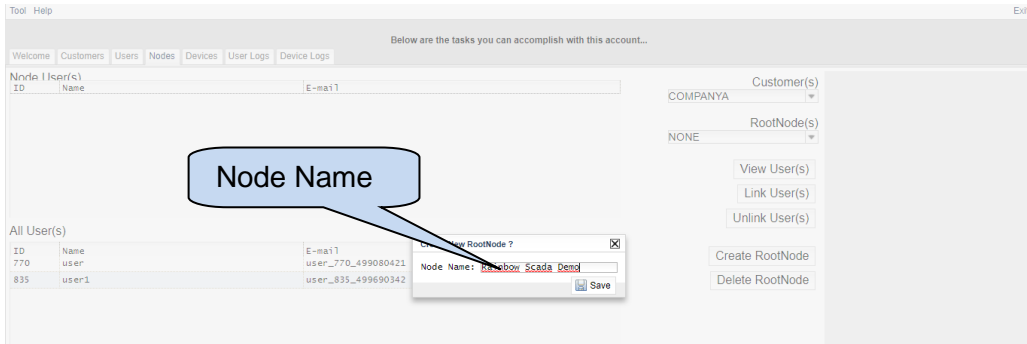

Root Node will appear at the right column.



To add sub-nodes, right click on the root node and then select **Add Node**.

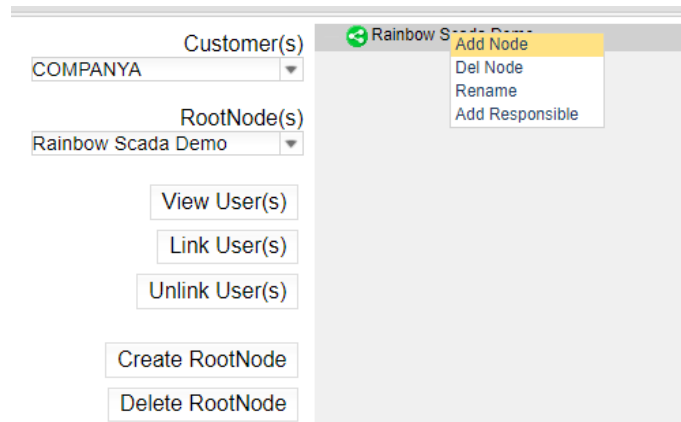

Write a node name and click **Save**.

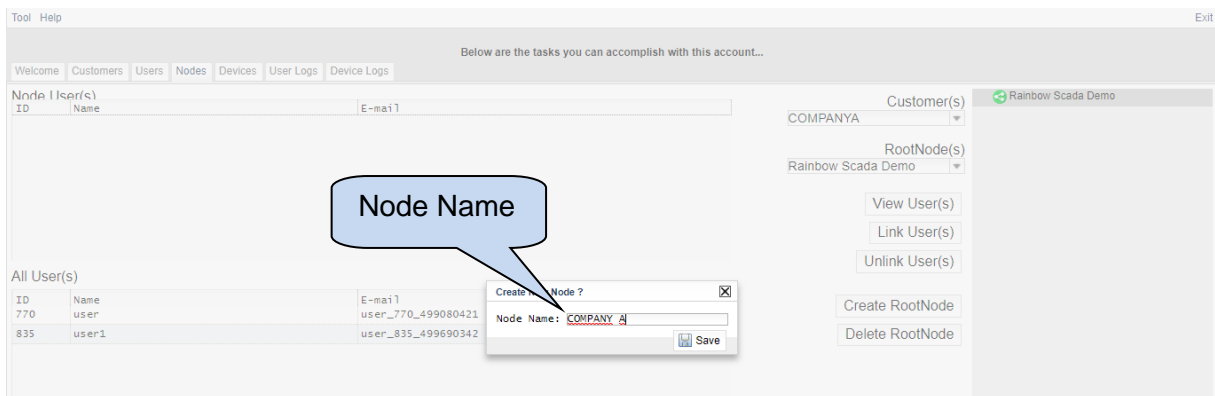

A sample node structure can be seen below:

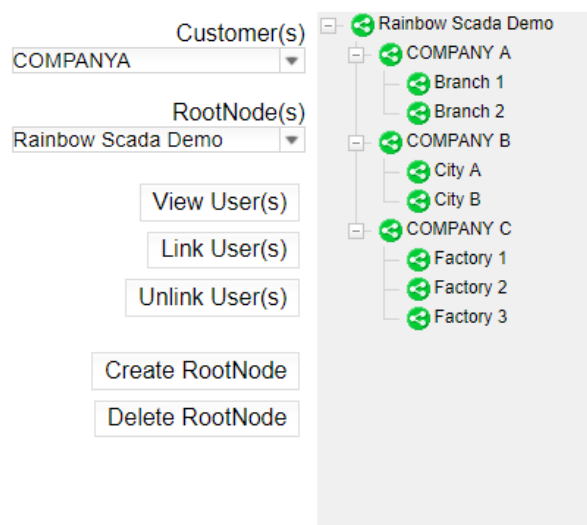

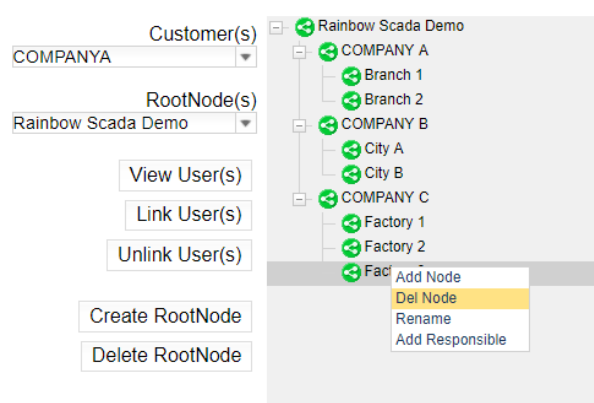

To delete any of the nodes; right click on the node and select **Del Node**.



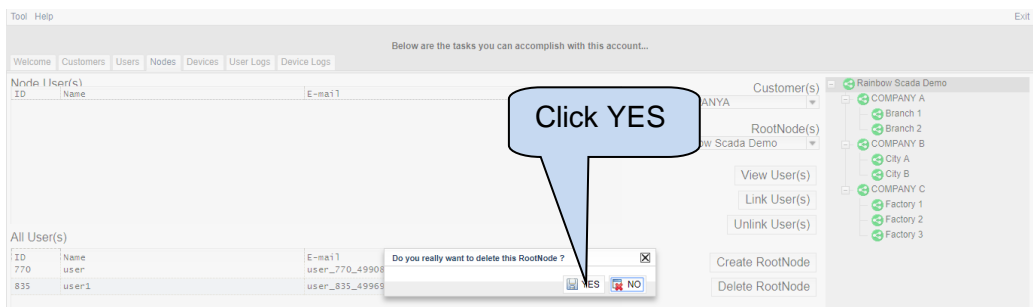
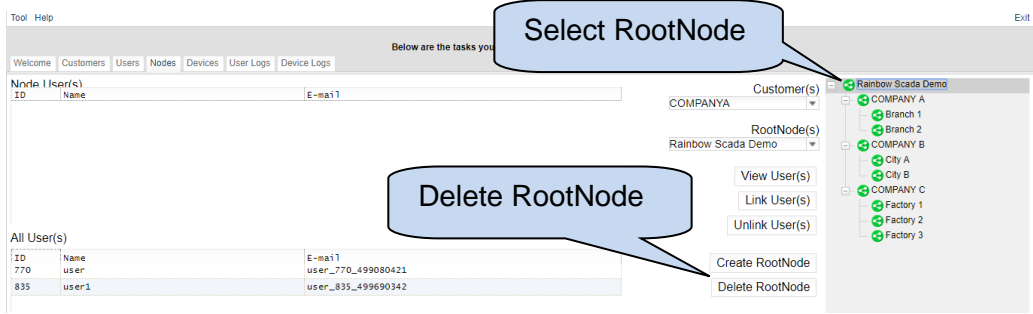

To delete the **RootNode**; select the RootNode and click **Delete RootNode**.



 **If RootNode is deleted, all its sub-nodes will also be deleted.**

All user accounts are viewed on this screen.

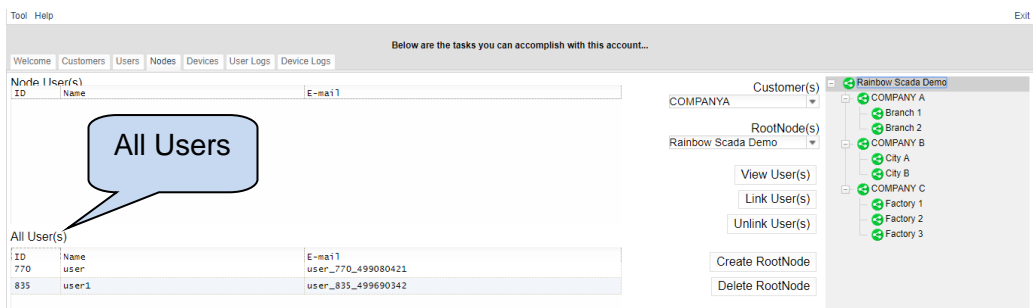

It is possible to link users for the related nodes. Thus, all users will only have permission to access their own nodes.

Select a user from all users list.

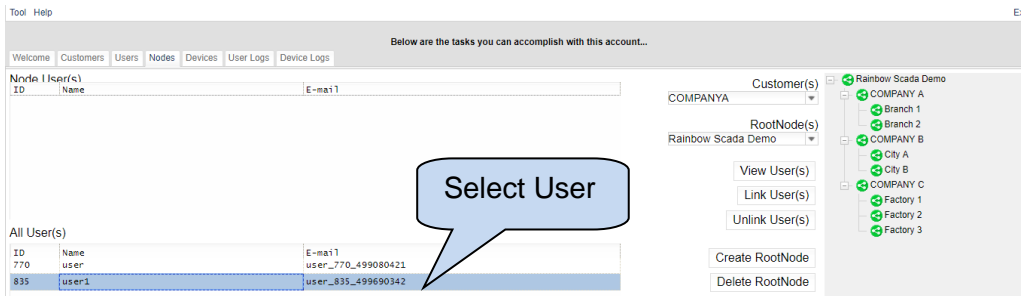

Select a Node to link the user.

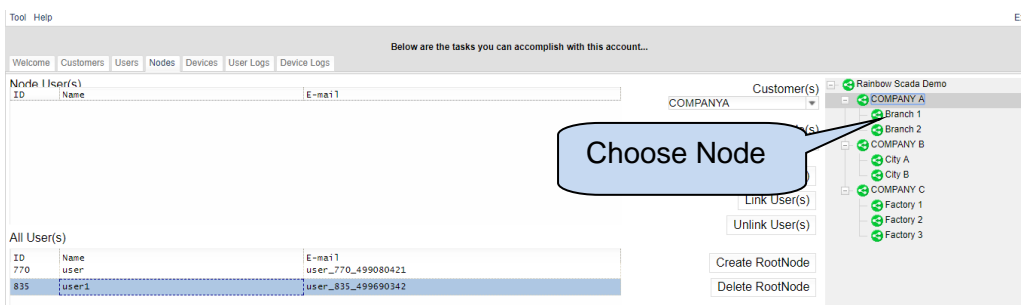

Click **Link User(s)**.

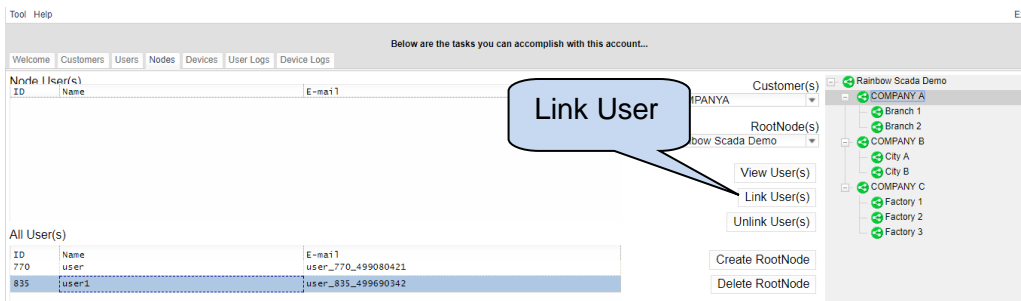

User(s) will be listed under the **Node User(s)**.

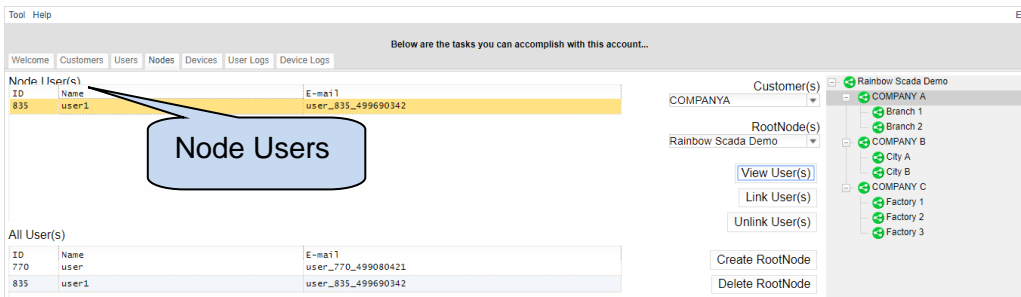



More than one user can be linked to a Node.

To view a Node's User(s), select the node and then click **View User(s)**.

The screenshot shows the software interface with the 'Node User(s)' list containing one user: ID 835, Name user1, E-mail user_835_499690342. A callout bubble labeled 'View Users' points to the 'View User(s)' button in the right-hand panel. The 'All User(s)' list below shows three users: ID 770 (user), ID 835 (user1).

To unlink a user, select it from Node User(s) List and then click **Unlink User(s)**.

The screenshot shows the software interface with the 'Node User(s)' list containing one user: ID 835, Name user1, E-mail user_835_499690342. A callout bubble labeled 'Select User' points to the user row. Another callout bubble labeled 'Unlink User' points to the 'Unlink User(s)' button in the right-hand panel. The 'All User(s)' list below shows three users: ID 770 (user), ID 835 (user1).

User(s) will be deleted from Node User(s) list.

The screenshot shows the software interface with the 'Node User(s)' list empty. The 'All User(s)' list below still shows three users: ID 770 (user), ID 835 (user1). The 'Unlink User(s)' button in the right-hand panel is now disabled.

2.1.3. Add Device

To add devices, click **Devices** tab.

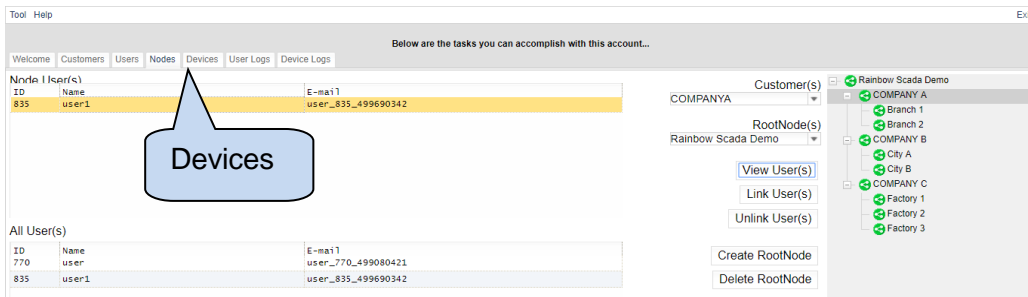

If there is no device added on account, device list will be empty.

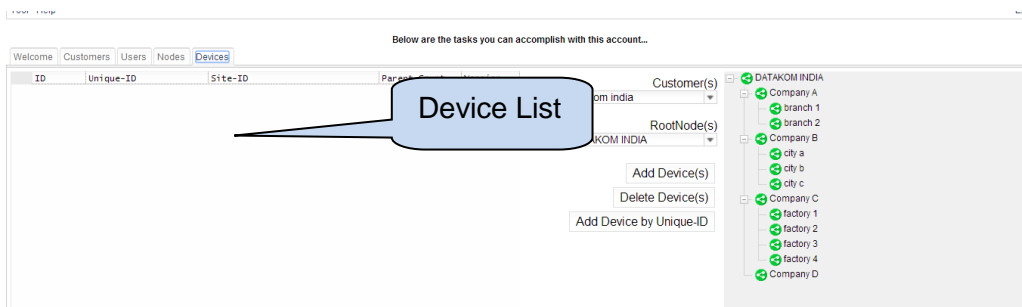

To add a device, its Unique ID number must be known.

The Unique ID number can be found on screen of the device.



Click **Add Device by Unique ID**.

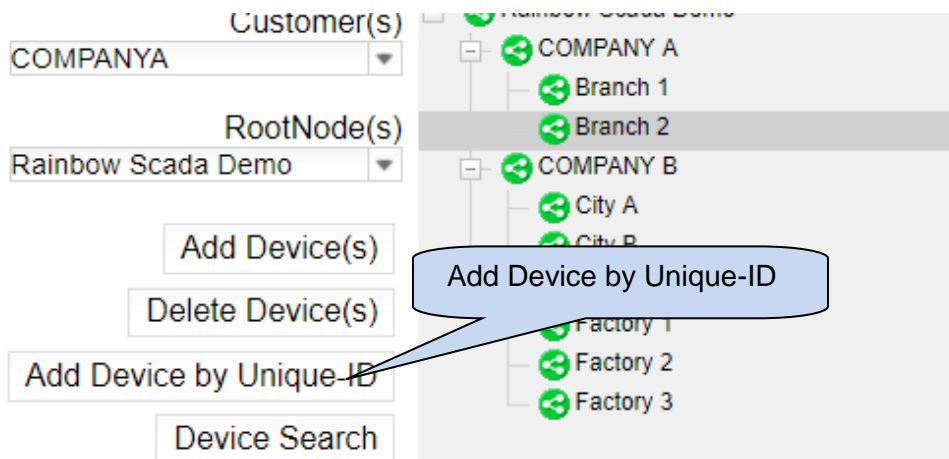

Write the Unique ID number on the viewed screen and click **Save**.



Device will be Seen on the Device List.



If an invalid Unique ID number is entered, Device Not Found message will appear on the screen.

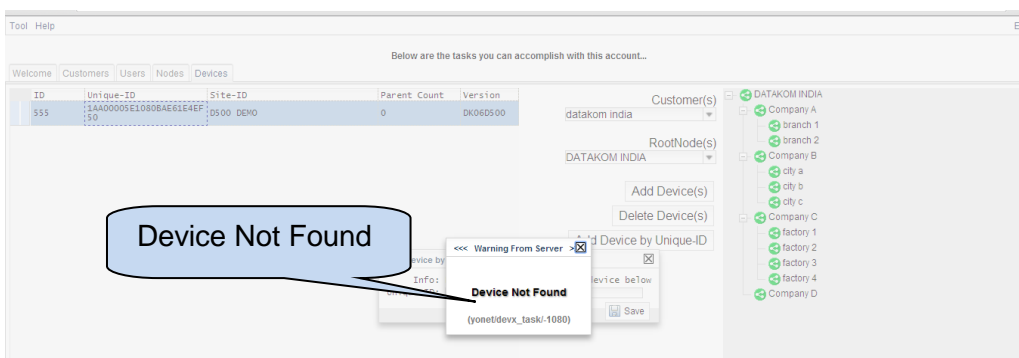

If device is already defined for another user account, “Device Belongs to Someone Else” error message will be displayed on the screen.

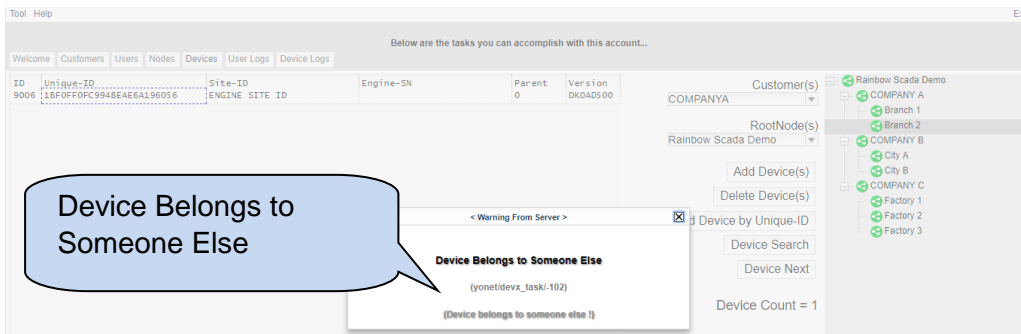

Once the device is added, since it is not linked with any node, parent count will be zero.

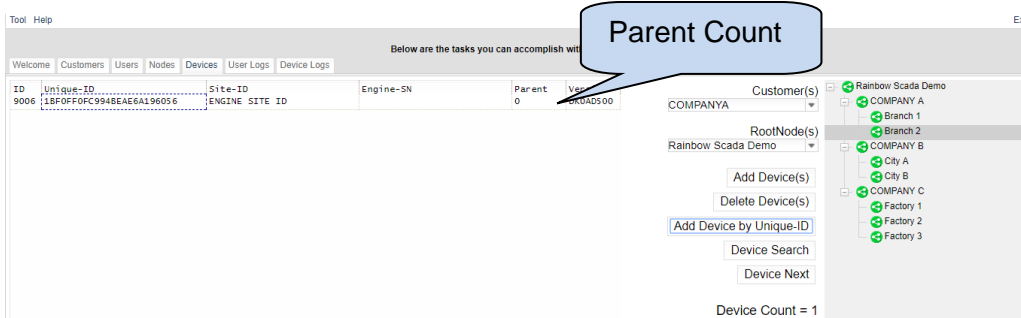

In order to link the device with a node; select the device, select the node and then click **Add Device(s)** tab.

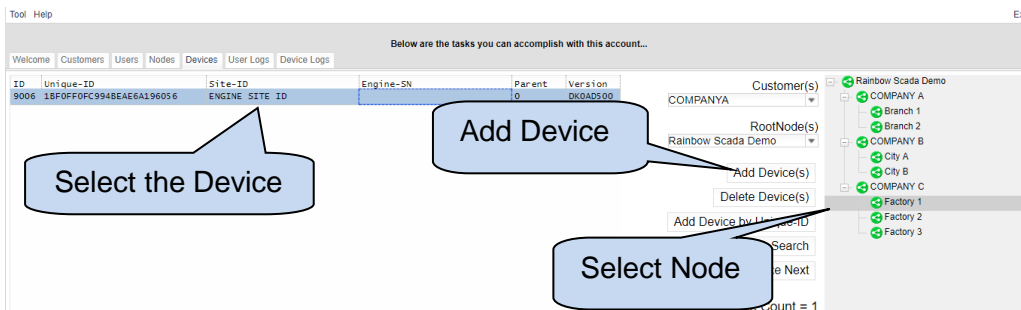

Device will be set under the selected node;

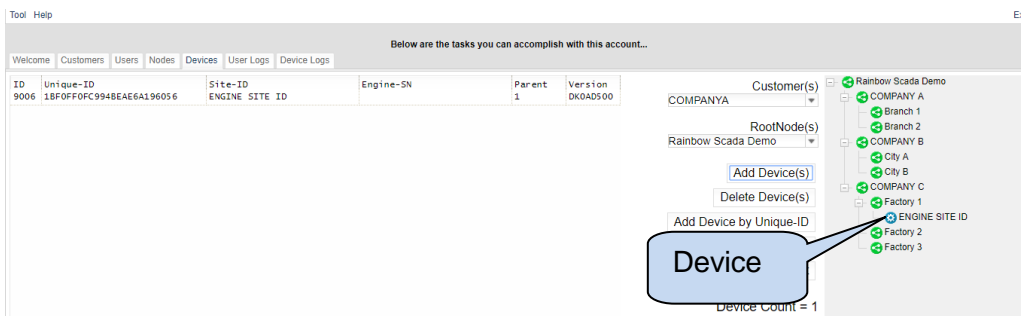

To delete a device; select device and then click **Delete Device(s)**.

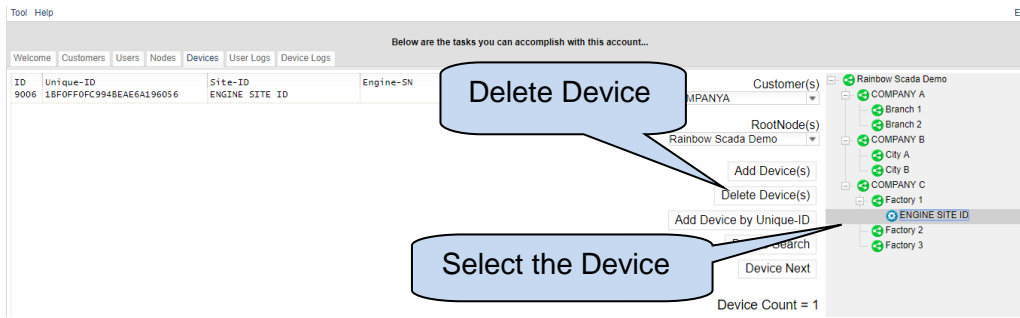

3. MONITORING ACCOUNT LOGIN

Click on the below link to access to Rainbow Scada:

<http://rm.datakom.com.tr/>

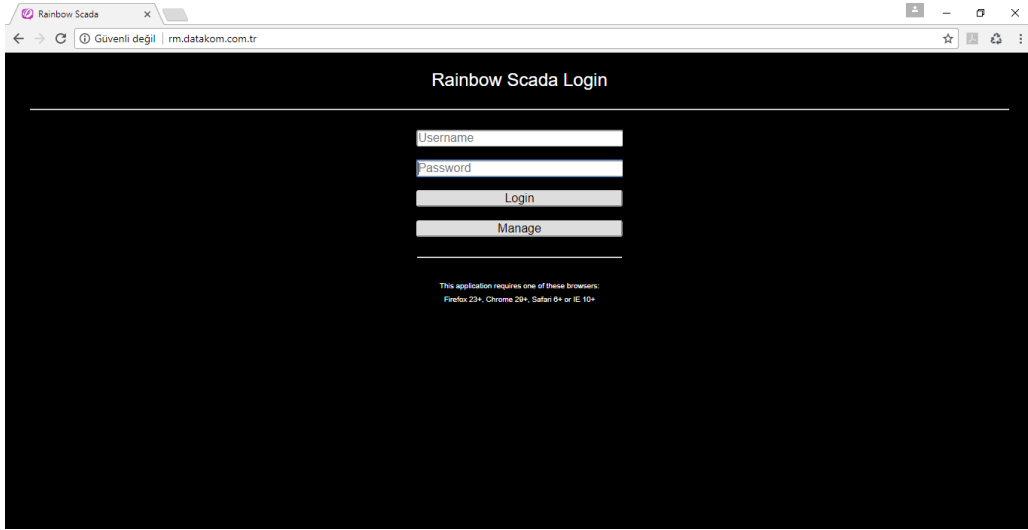

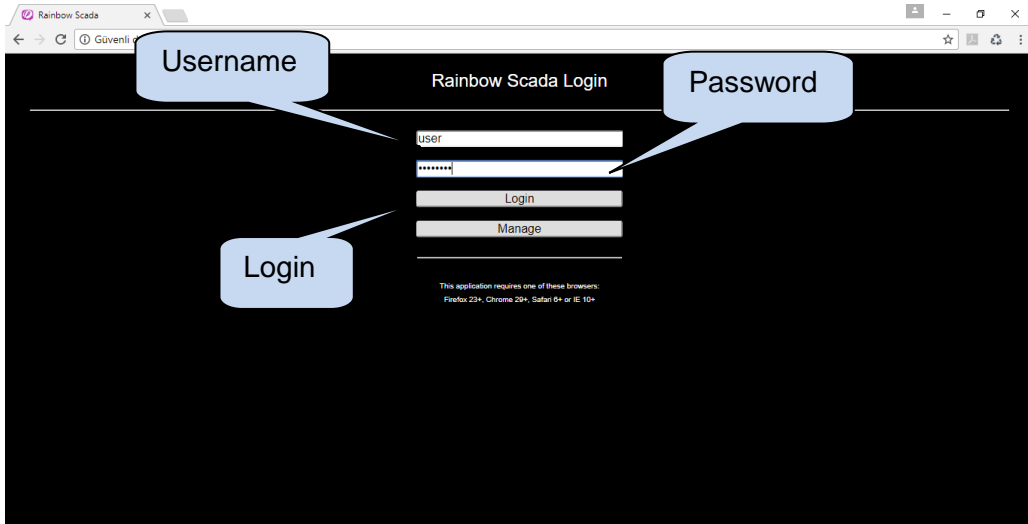

Rainbow Scada application requires Firefox 23+, Chrome 29+, Safari 6+ or IE 10+

Type user name and password and click **Login**.

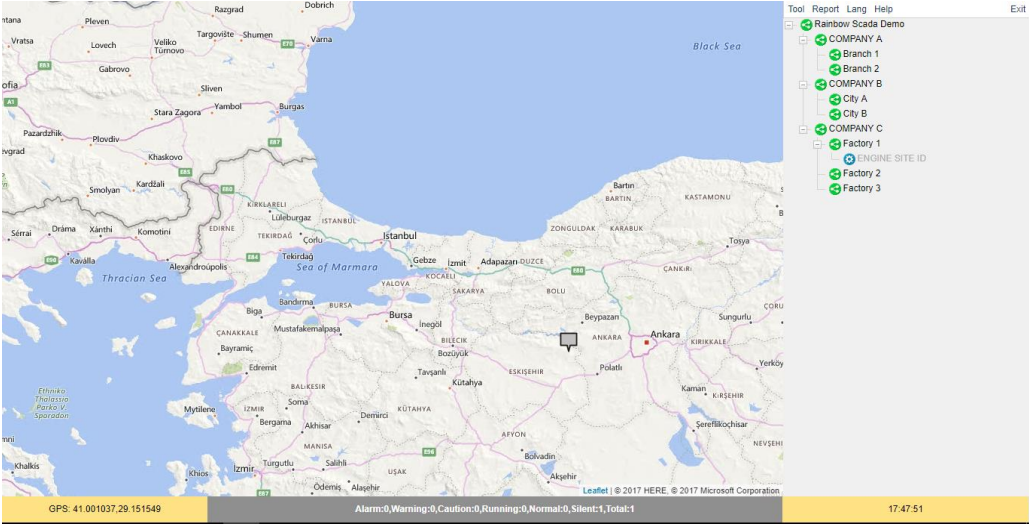

Main screen of the monitoring page will be viewed.



 If the account has no nodes, “User Has No Nodes” message will appear.

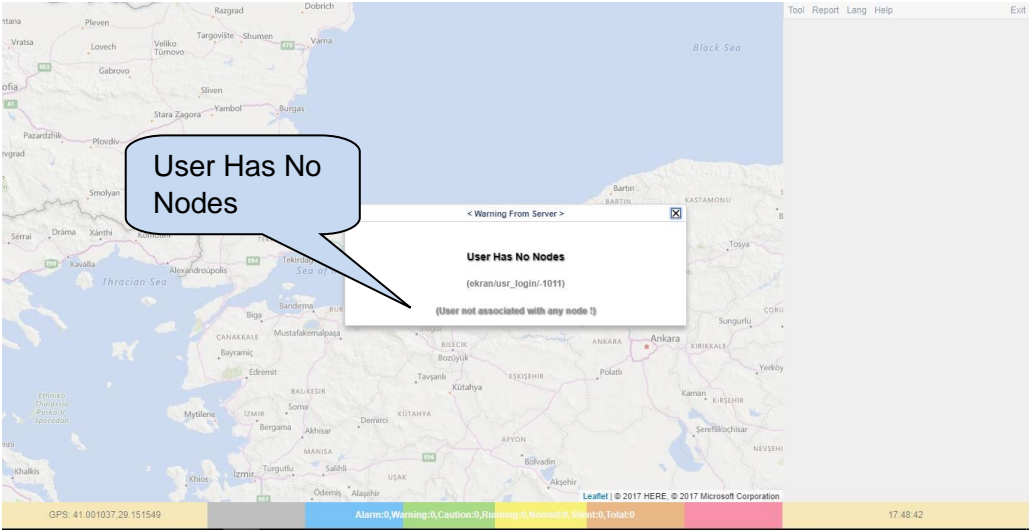





3.1. OVERVIEW

Every device is represented by a colour box, both on the map and on the right hand tree structure.

Colors on the map are sorted so that the most important information overrides other information.

On the right hand side tree structure, a controller with a fault condition will turn all upper levels to this color.

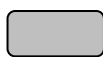
The color coding is as follows:

-  **RED:** The controller has a high priority fault condition (shutdown or load dump alarm)
-  **ORANGE:** The controller has a low priority fault condition (a warning)
-  **GREY:** The controller has stopped communication with the Rainbow Scada program.
-  **GREEN:** The genset is running, there is no fault condition.
-  **BLUE:** The controller is at rest, genset is not running, there is no fault condition.

The detailed number of controllers are written under the map

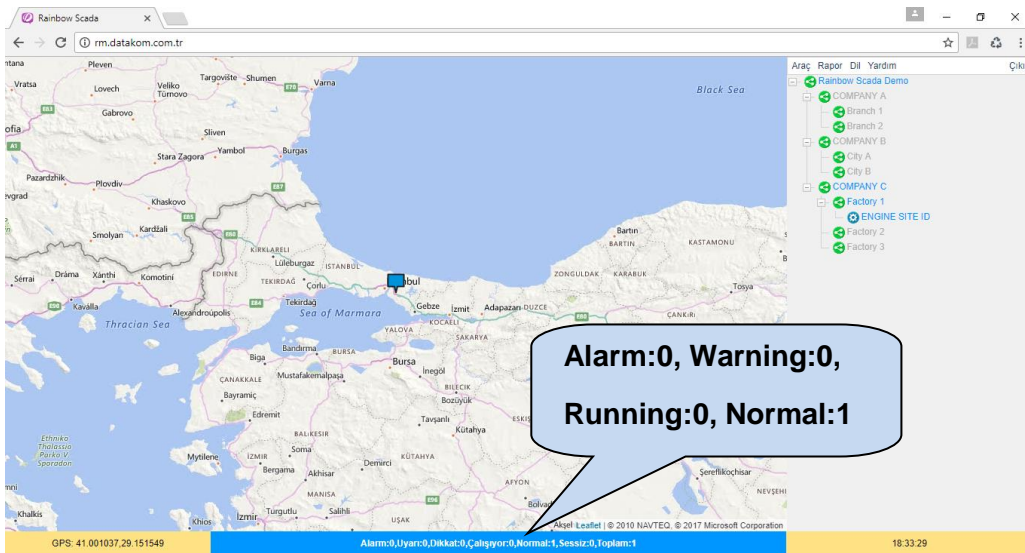

As Engine Site ID controller is orange, indicating a warning condition, then factory 1, Company C, Rainbow Scada Demo become orange.

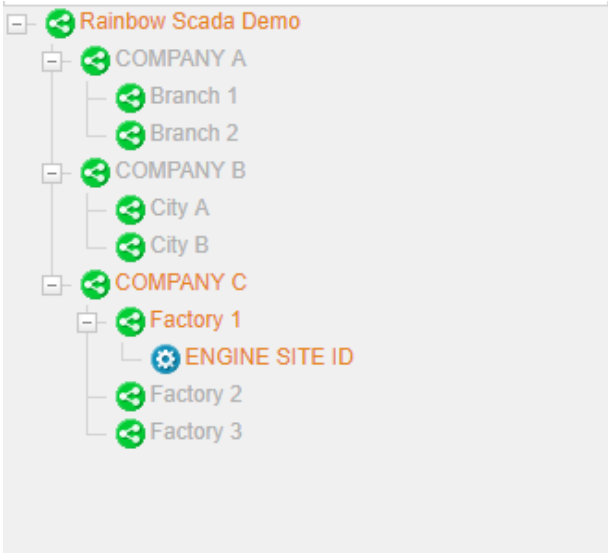

If a controller is clicked on the Map, the information screen will be opened.

Device Values (D500 DEMO)

Summary Information Genset Mains Engine Alarms Control Outputs

Mains L1 : 223.5 V	Genset L1 : 223.4 V	Battery Voltage : 13.50 Vdc
Mains L2 : 220.2 V	Genset L2 : 220.3 V	Engine RPM : 1498 RPM
Mains L3 : 225.4 V	Genset L3 : 225.2 V	Oil Pressure : 3.5 Bar / 50.7 Psi
Mains L1-L2 : 385.6 V	Genset L1-L2 : 385.5 V	Coolant Temp : 69.5 °C / 157.1 °F
Mains L2-L3 : 385.5 V	Genset L2-L3 : 385.3 V	Oil Temp : 69.5 °C / 157.1 °F
Mains L3-L1 : 387.7 V	Genset L3-L1 : 387.5 V	Fuel Level : 51.1 %
Mains I1 : 0.0 A	Genset I1 : 205.2 A	Engine Run Hours : 2416.81 Hrs
Mains I2 : 0.0 A	Genset I2 : 289.4 A	Total kWh : 333366.0 kWh
Mains I3 : 0.0 A	Genset I3 : 0.0 A	Total kVArh (Ind) : 0.1 kVArh
Mains Freq : 49.96 Hz	Genset Freq : 49.96 Hz	Total kVArh (Cap) : 50331.2 kVArh
Mains P Total : 0.0 kW	Genset P Total : 109.1 kW	Hours to SrV1 : -2166.81 Hrs
Mains Q Total : 0.0 kVAR	Genset Q Total : -6.6 kVAR	Days to SrV1 : 79.20 Day
Mains S Total : 0.0 kVA	Genset S Total : 109.4 kVA	
Mains Pwr Factor : 1.000	Genset Pwr Factor : 0.998	

3.2. MENU

Right-click on a device to view a menu for the list of possible actions related to that device.

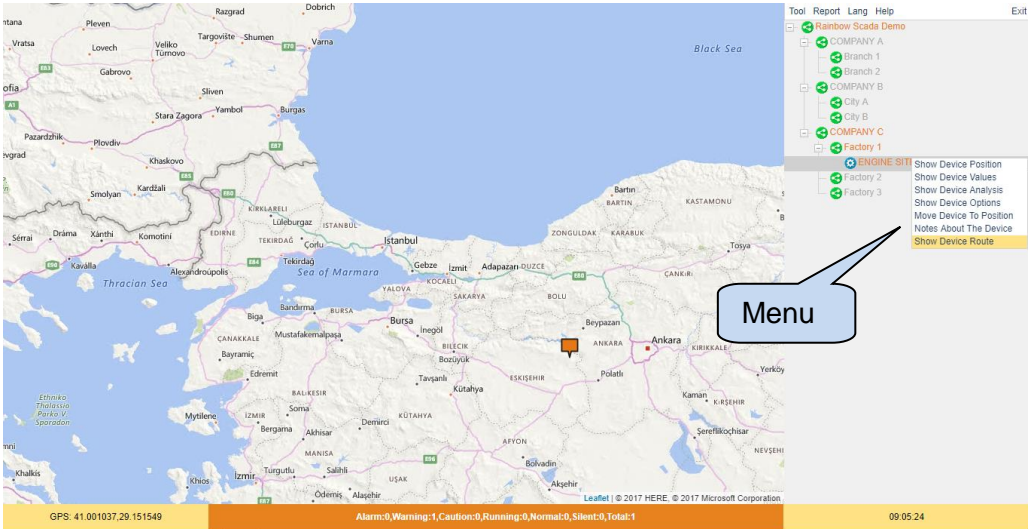

3.2.1. Show Device Position

Click **Show Device Position** to align the device at the center of the map.



3.2.2. Show Device Values

Select **Show Device Values** to view the summary screen. Most vital information will be viewed on this screen.

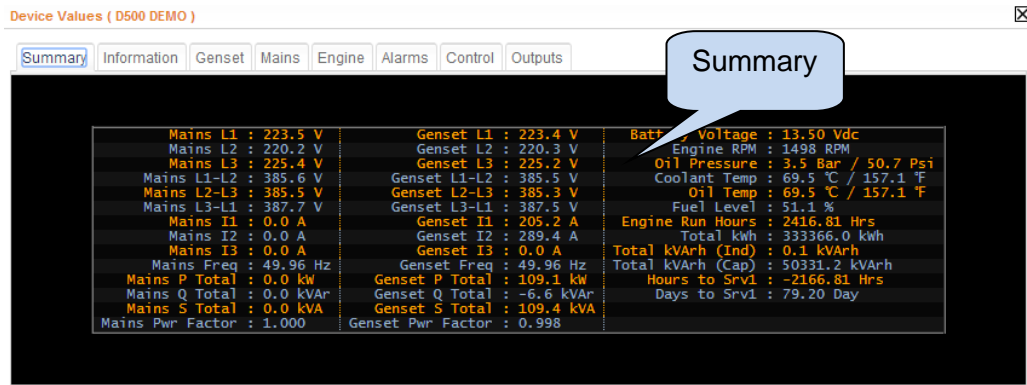

Alarm screen will display all existing alarms on the controller.

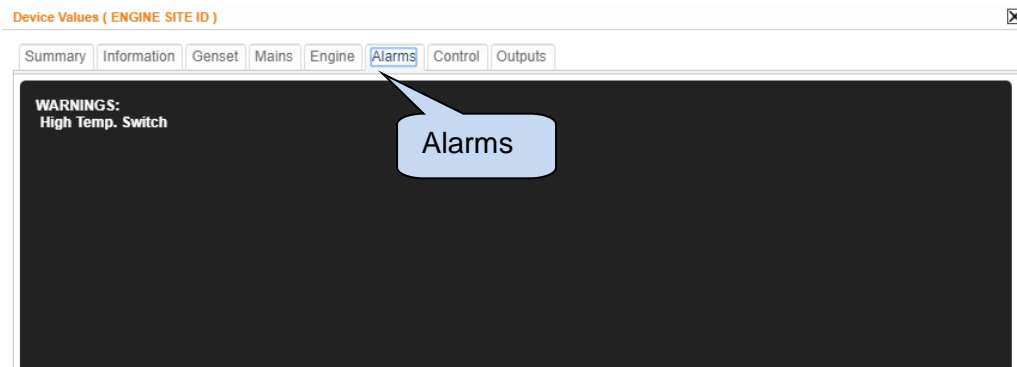

Click **Control** tab, Keypad screen will be viewed.

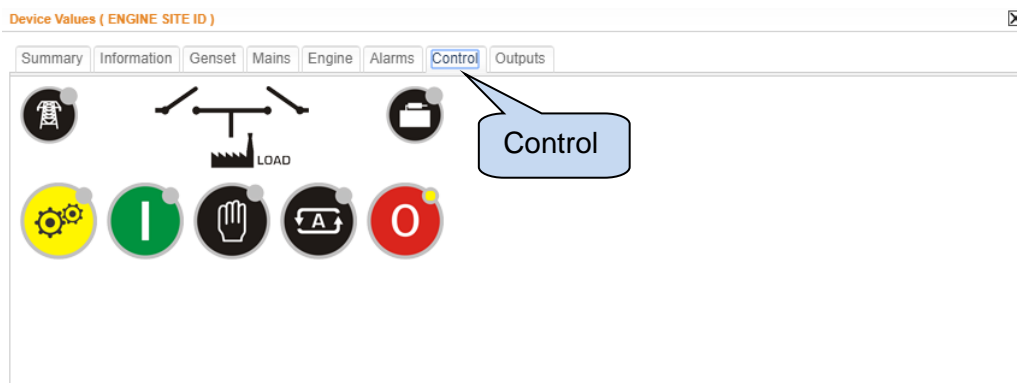

This Keypad is functional but not real-time like a physical Keypad. Depending on the connection type and quality, feedback might lag.

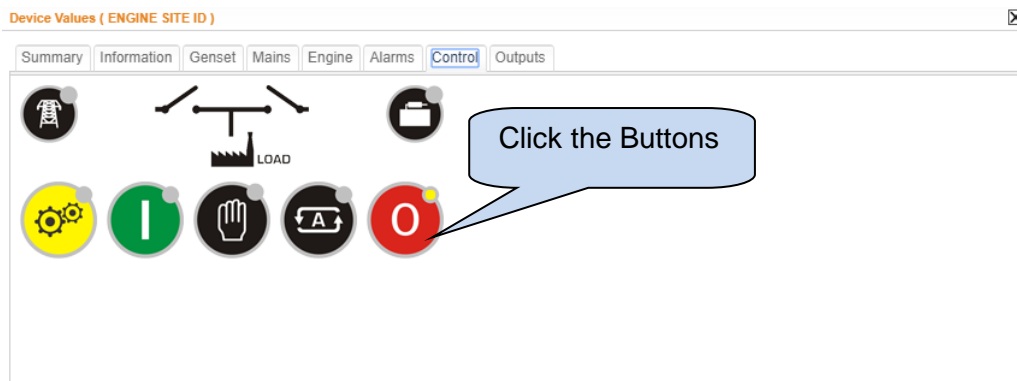

Click **Outputs** tab to view remote controlled digital outputs screen.

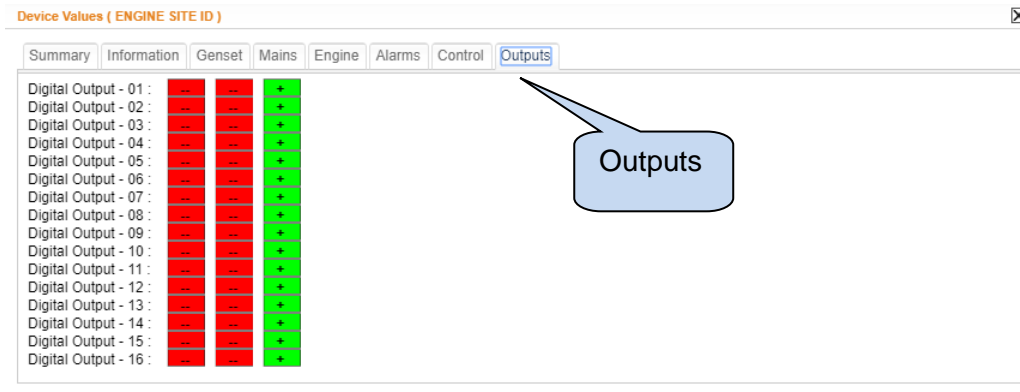

The D-500 genset controller offers 16 externally controllable digital output functions.

These output functions have no effect in the operation of the unit; however they can be redirected to any digital output, allowing remote control of functions or external devices.

The remote control of these outputs are enabled through Rainbow Scada remote control functions.



Output status are kept in a non-volatile memory and are not affected by power failures.

Click  button to activate the remote output.

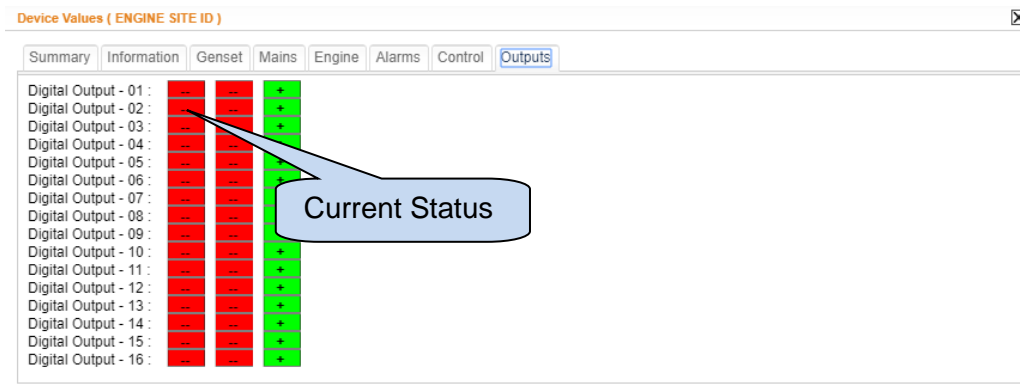

Click  button to disable the remote output.

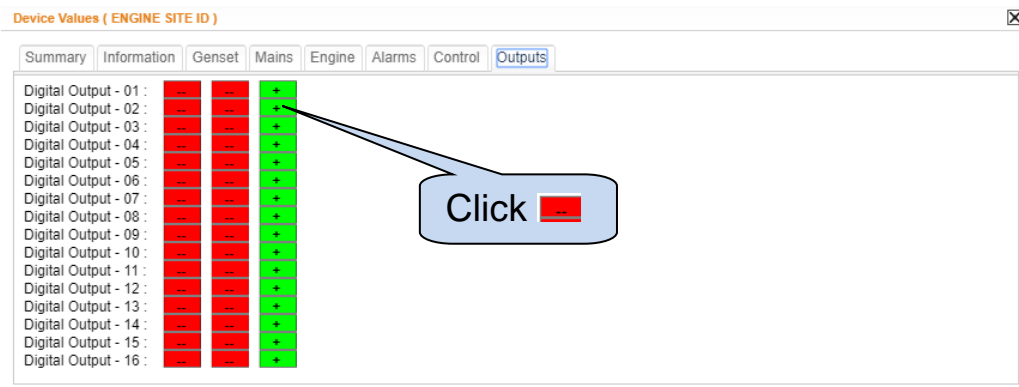

3.2.3. Show Device Analysis

Click **Show Device Analysis** to view analysis page.

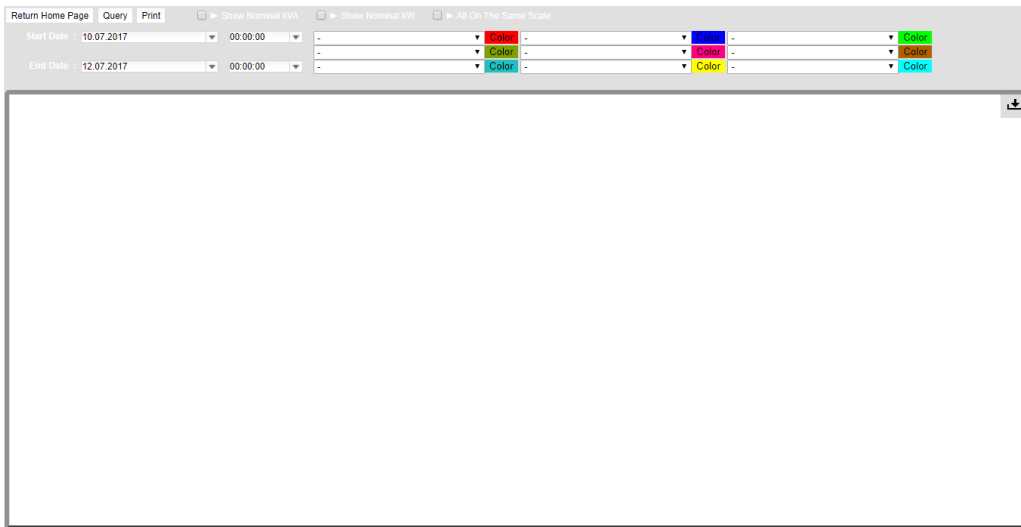

Device analysis function allow users to access stored data on server. It is possible to analyse past performance of your system.

9 different data can be displayed on one screen by selecting from boxes.

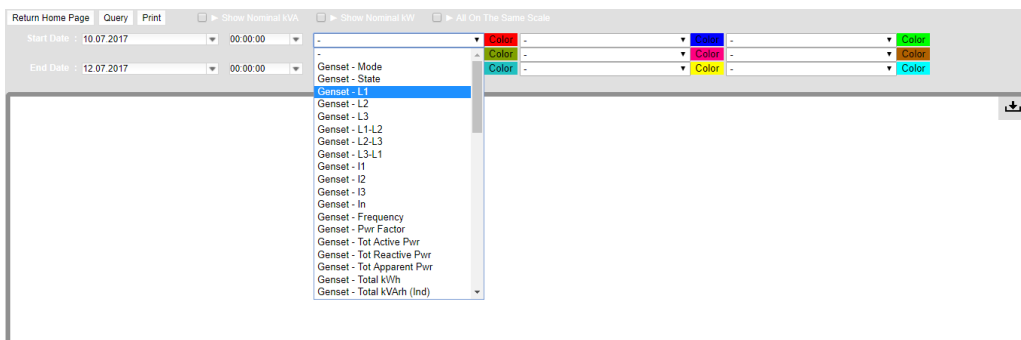

Color coding of the graphs can be edited.

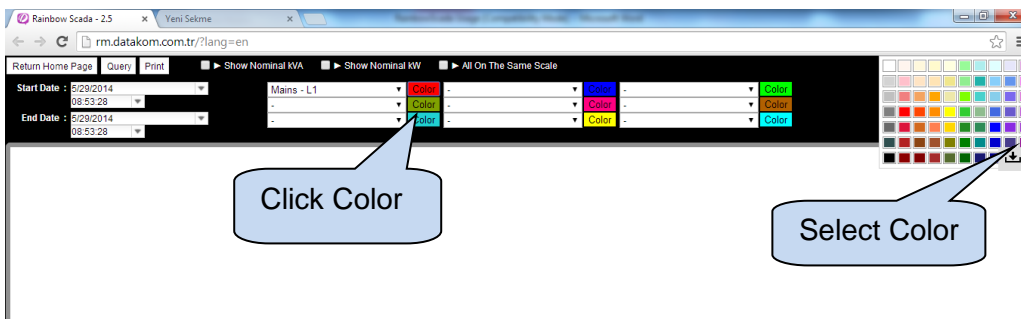

Select start date and end date.

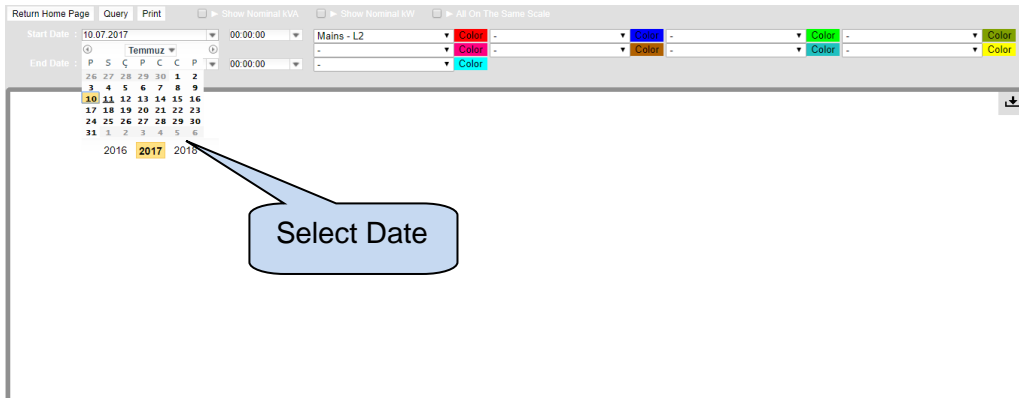

Click **Query** button. The graph will be generated within selected dates.

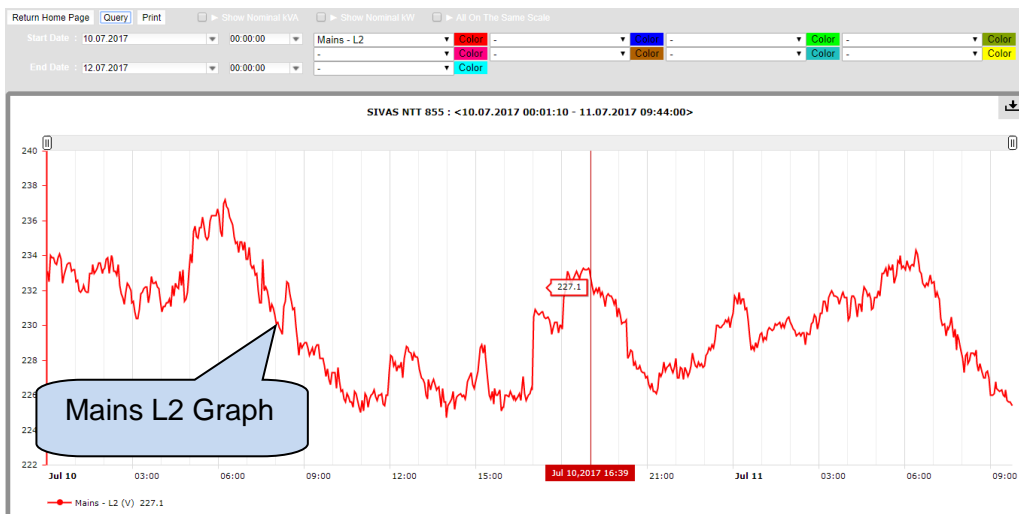

Use sliders to Zoom in and out.

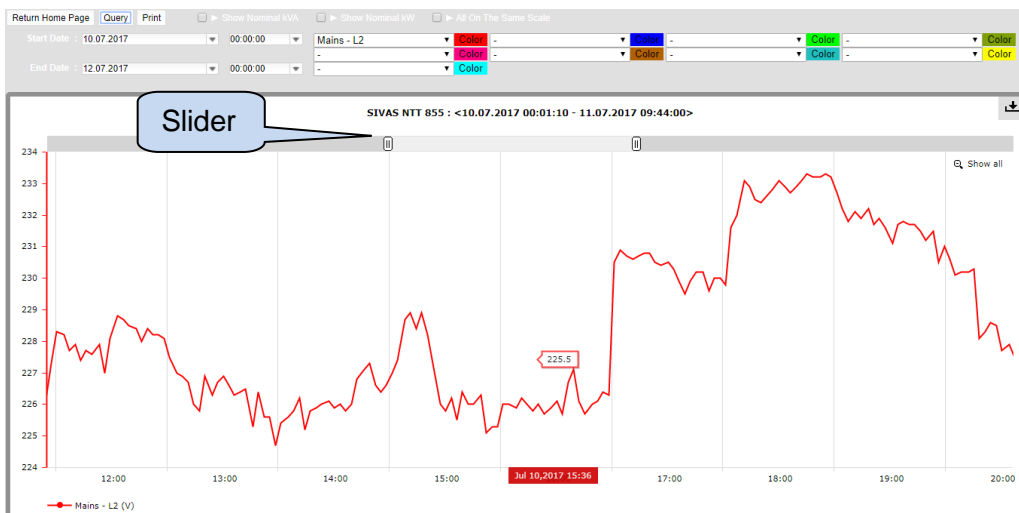

Click **Print** button to print the displayed graph.

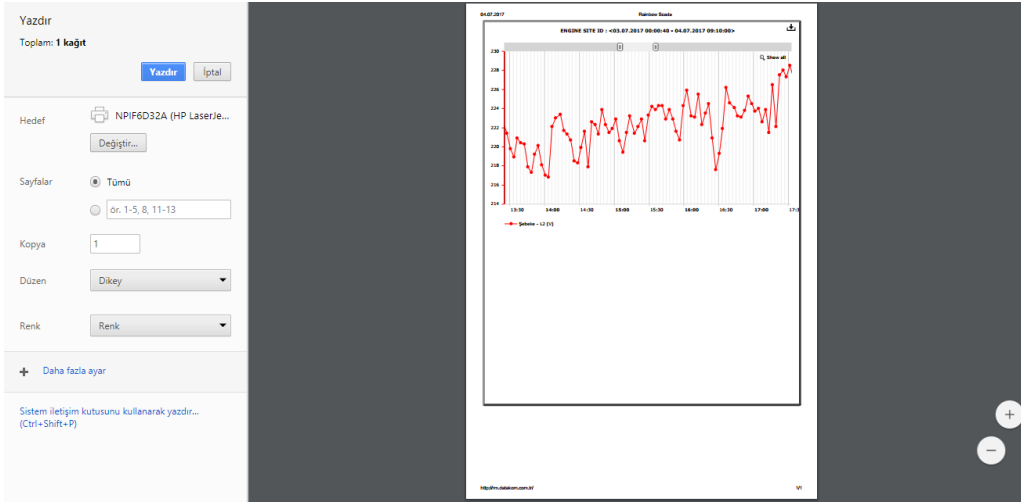
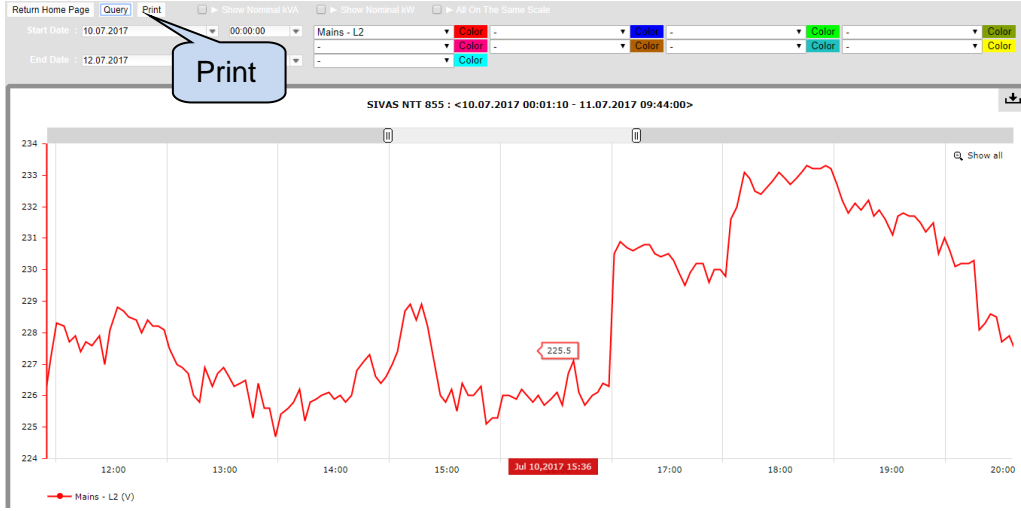

Click download to save the graph as .csv, jpg or png file.

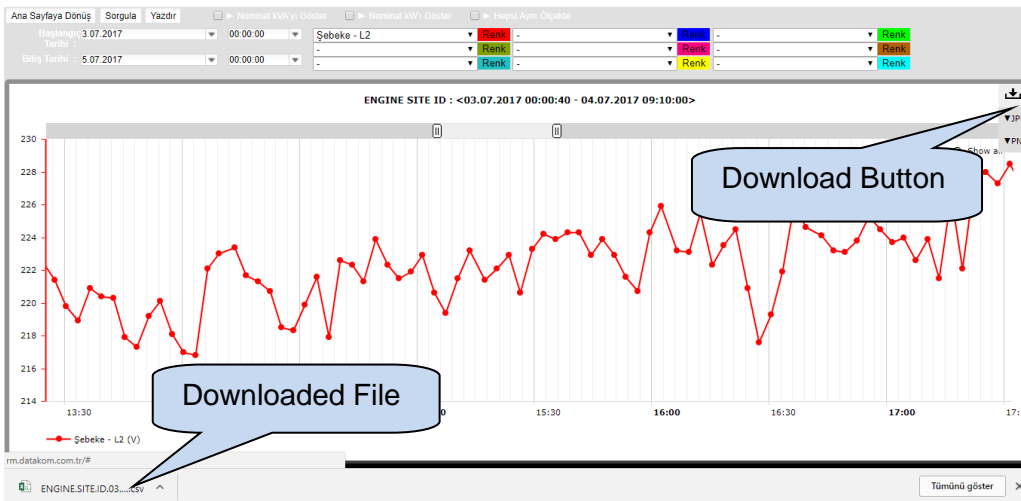

Select **All On The Same Scale** to display all the graphs on the same scale.

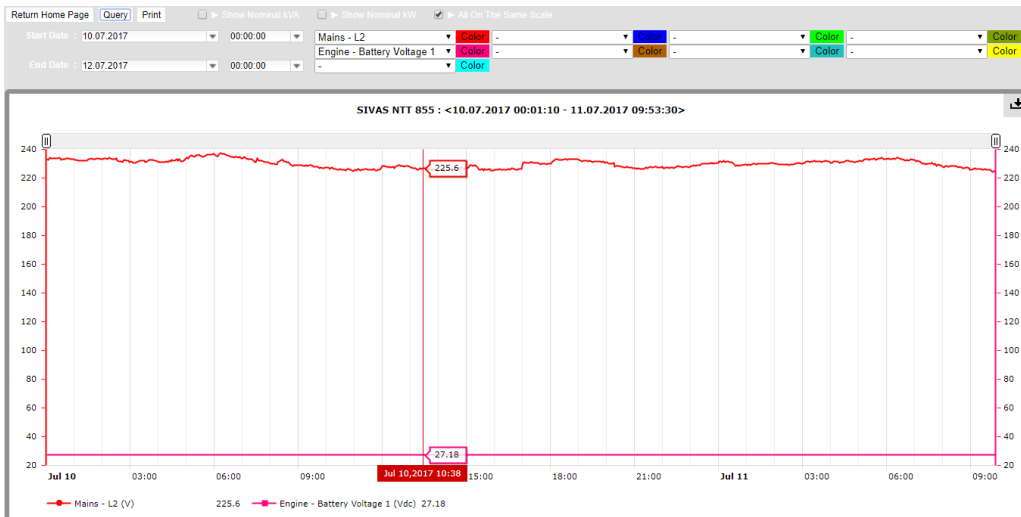
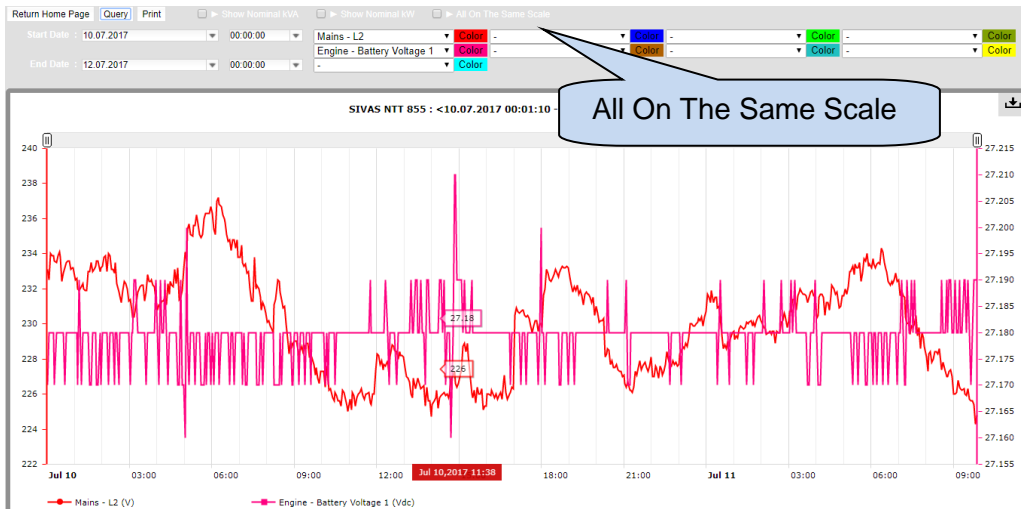

If Show Nominal kVA and show Nominal kW are selected, nominal kVA and kW values are displayed on the same graph.

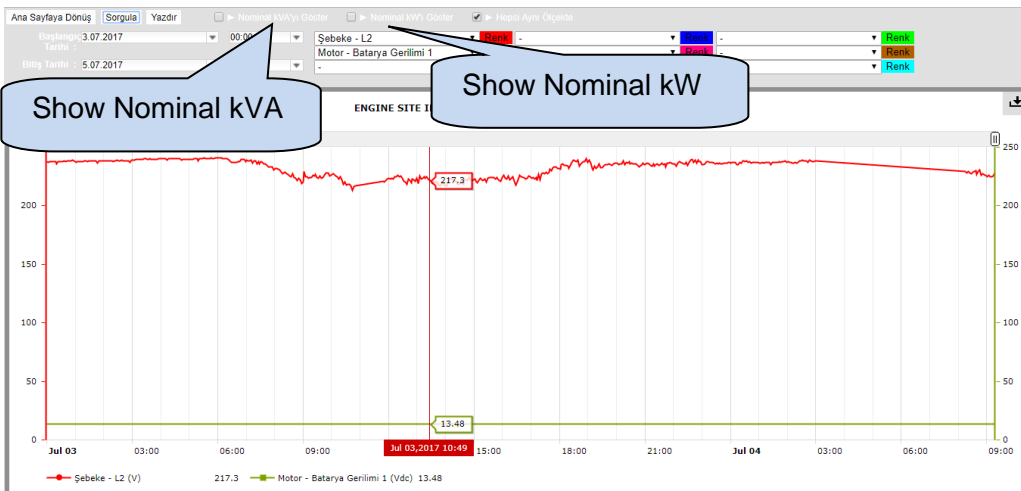

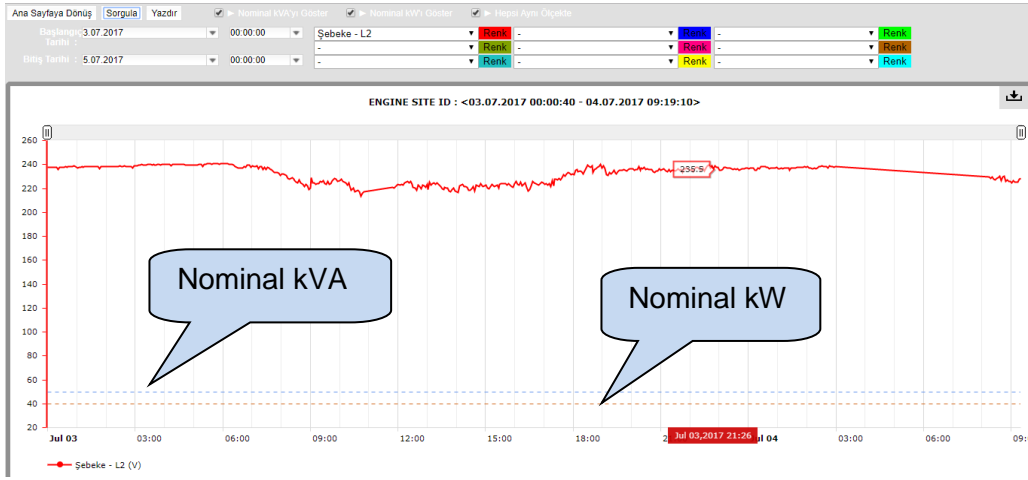

Click **Return Home Page** for the main screen.

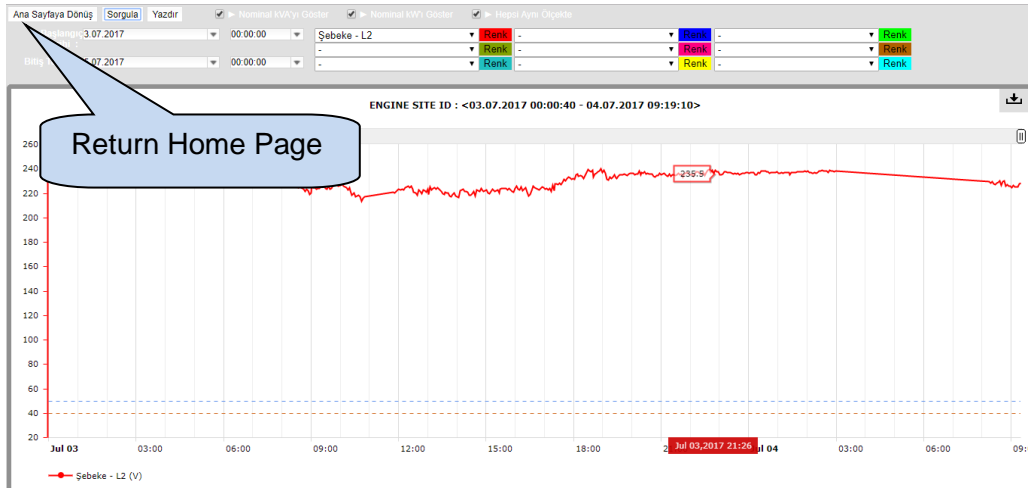

3.2.4. Show Device Options

Select **Show Device Options** to view device options. List of available functions will be displayed.



Site ID and Unique ID number will be displayed on this screen.

A screenshot of a 'Device Options' form. The form contains several input fields and checkboxes. Two blue callout boxes are present: one pointing to the 'Site-ID' field which contains the text 'ENGINE SITE ID', and another pointing to the 'Unique-ID' field which contains the hexadecimal string '1BF0FF0FC994BEAE6A196056'. Other fields include 'GPS Lock' (checked), 'Latitude' (39,83385), 'Longitude' (31,717529), 'Altitude' (0), 'Time Update' (unchecked), 'Move Notify' (unchecked), 'Nominal (kw)' (0), 'Nominal (kVA)' (0), and 'Battery End' (0). At the bottom of the form are 'Save' and 'Cancel' buttons.

If GPS Lock is selected, the device position will be locked.

The screenshot shows the 'Device Options' form with the following fields and values: Site-ID: ENGI, Unique-ID: 1BF0FF0FC9948EAE6A196056, GPS Lock: , Latitude: 39,83385, Longitude: 31,717529, Altitude: 0, Time Update: , Move Notify: , Nominal (kW): 0, Nominal (kVA): 0, Battery End: 0. A blue callout bubble labeled 'GPS Lock' points to the checked checkbox. At the bottom right are 'Save' and 'Cancel' buttons.

It is possible to manually enter Latitude, Longitude and Altitude values.

This screenshot is identical to the previous one, but includes three blue callout bubbles: 'Latitude' pointing to the Latitude field, 'Longitude' pointing to the Longitude field, and 'Altitude' pointing to the Altitude field. The 'GPS Lock' checkbox remains checked.

If Time Update is selected, the device data-time will be automatically synchronized to the server.

The screenshot shows the 'Device Options' form with the following fields and values: Site-ID: ENGINE SITE ID, Unique-ID: 1BF0FF0FC9948EAE6A196056, GPS Lock: , Latitude: 39,83385, Longitude: 31,717529, Altitude: 0, Time Update: , Move Notify: , Nominal (kW): 0, Nominal (kVA): 0, Battery End: 0. A blue callout bubble labeled 'Time Update' points to the checked checkbox. At the bottom right are 'Save' and 'Cancel' buttons.

If Move Notify is selected, the system will send e-mails to defined e-mail addresses if the device geo-position is changed. This is useful for mobile devices.

Device Options

Site-ID: ENGINE SITE ID

Unique-ID: 1BF0FF0FC994BEAE6A196056

GPS Lock:

Latitude: 39,83385

Longitude: 31,717529

Altitude: 0

Time Update:

Move Notify: **Move Notify**

Nominal (kW): 0

Nominal (kVA): 0

Battery End: 0

Save Cancel

If Nominal kW and kVA are entered, these values can be displayed on analysis screen.

Device Options

Site-ID: ENGINE SITE ID

Unique-ID: 1BF0FF0FC994BEAE6A196056

GPS Lock:

Latitude: 39,83385

Longitude: 31,717529

Altitude: 0

Time Update:

Move Notify:

Nominal (kW): 0 **Nominal kW**

Nominal (kVA): 0 **Nominal kVA**

Battery End: 0

Save Cancel

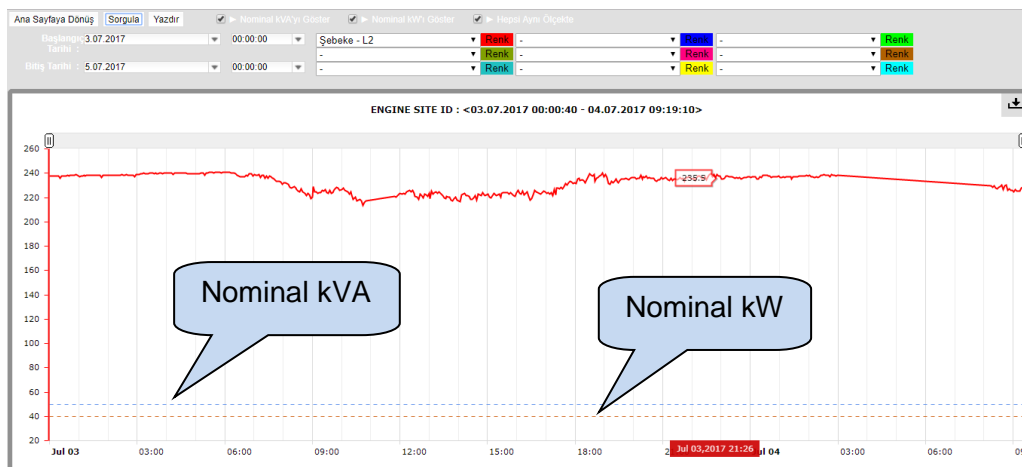

Click **Save** button to save the changes.

Device Options [X]

Site-ID:

Unique-ID:

GPS Lock:

Latitude:

Longitude:

Altitude:

Time Update:

Move Notify:

Nominal (kW):

Nominal (kVA):

Battery End:

Save **Cancel**

3.2.5. Move Device To Position

Click **Move Device To Position** to relocate the icon of this controller to the position of the Last Mouse Click.

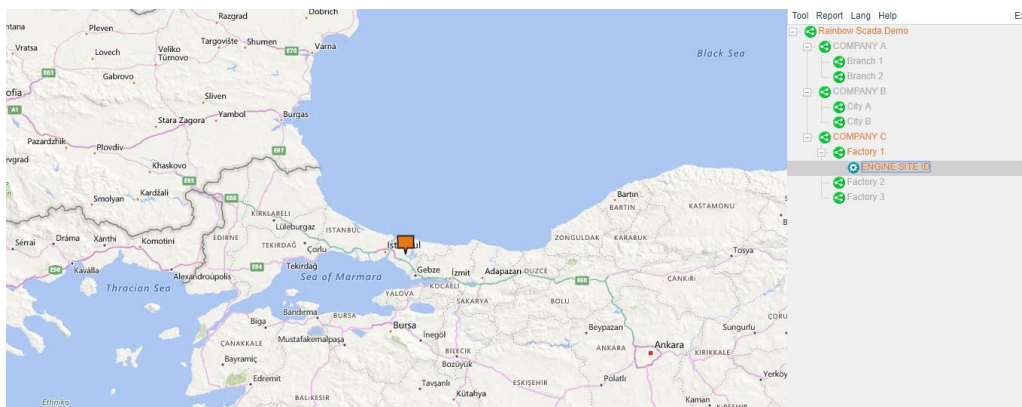
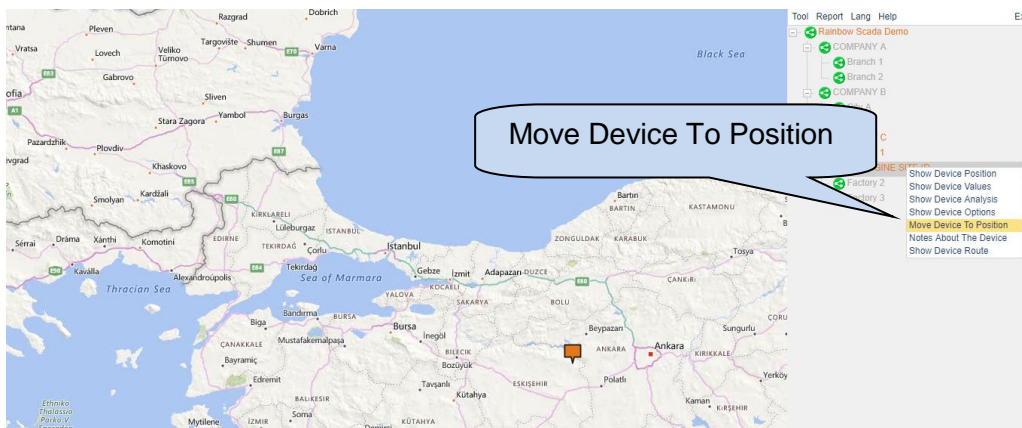

If GPS Lock is selected, Position Locked message will be displayed on the screen.



4. TOOLS

4.1. Tool

4.1.1 Change Password

It is possible to change password of the remote monitoring account. Click **Tool**, and click **Change Password**.

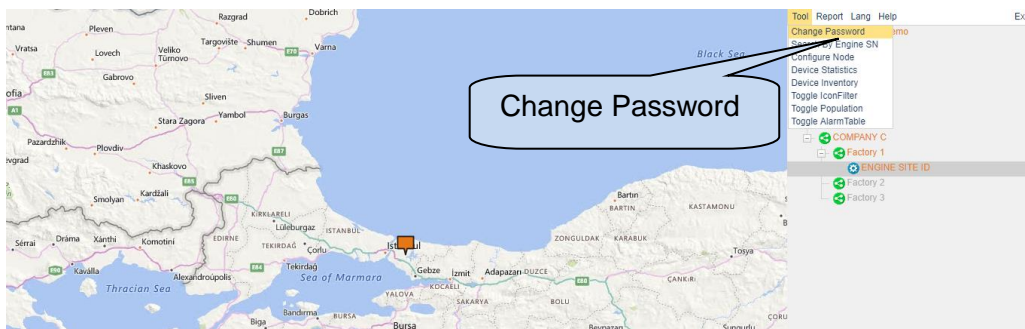

Enter current password, new password and then click **Change**.

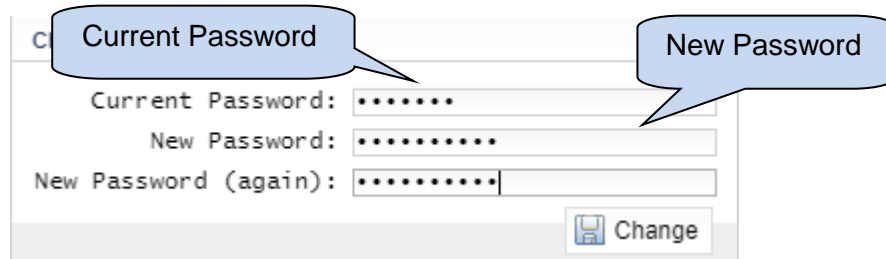
A screenshot of a password change form. The form has three input fields: 'Current Password', 'New Password', and 'New Password (again)'. Each field contains a series of dots representing masked characters. A blue callout box with the text 'Current Password' points to the first field. Another blue callout box with the text 'New Password' points to the second field. At the bottom right of the form, there is a button labeled 'Change' with a floppy disk icon.

If the same password is entered, warning message will be viewed.

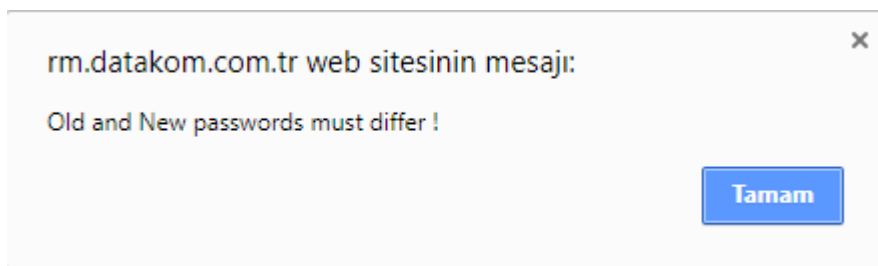

4.1.2 Search by Engine Serial Number

It is also possible to find the device once Unique ID is known. Click **Tool**, and click **Search by Engine SN**.

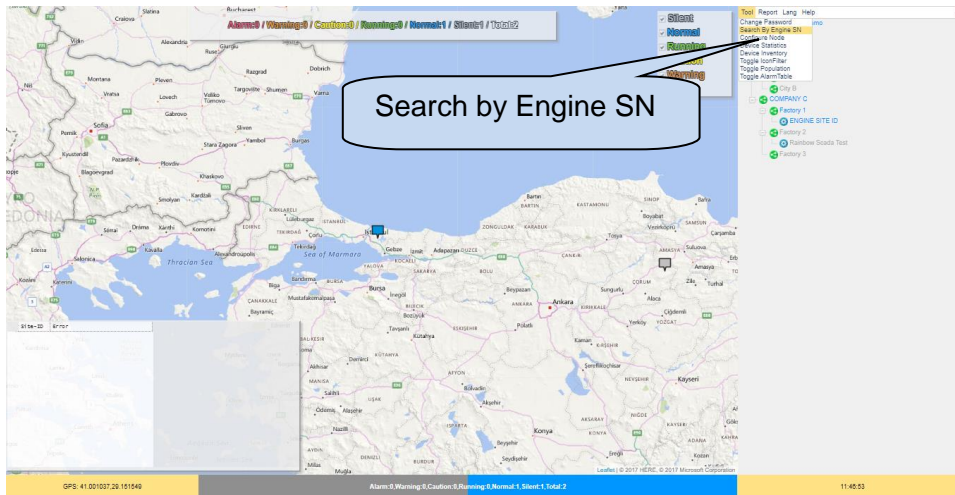

New window will appear asking the serial number to search. Please type the serial number of the unit.

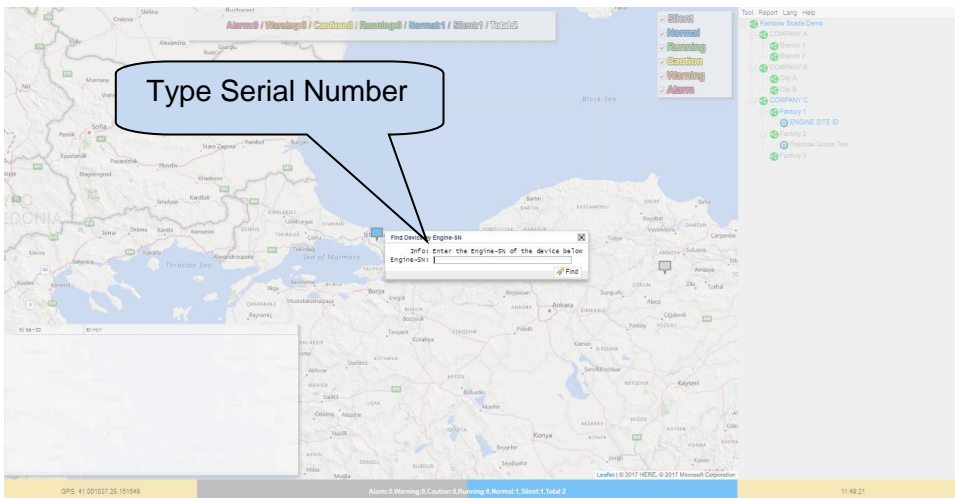

Once the entered serial number is matched with the unit, it will be highlighted on remote monitoring account.

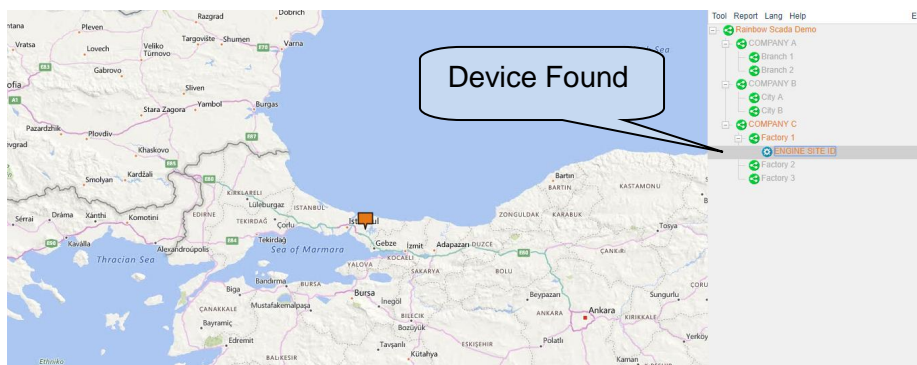

4.1.3 Device Statistics

Device Statistics tab under the Tool menu displays statuses of all devices graphically. Click **Tool**, and click **Device Statistics** tab.

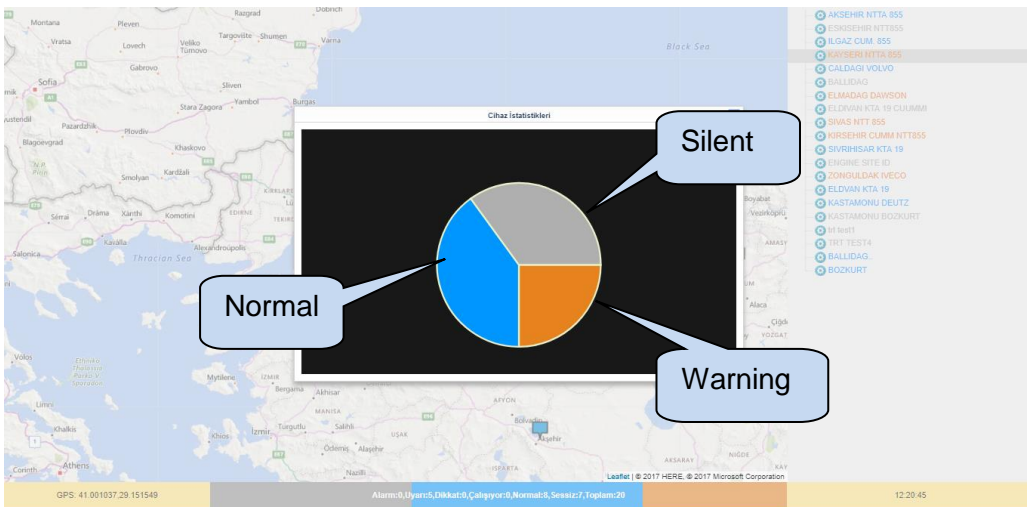
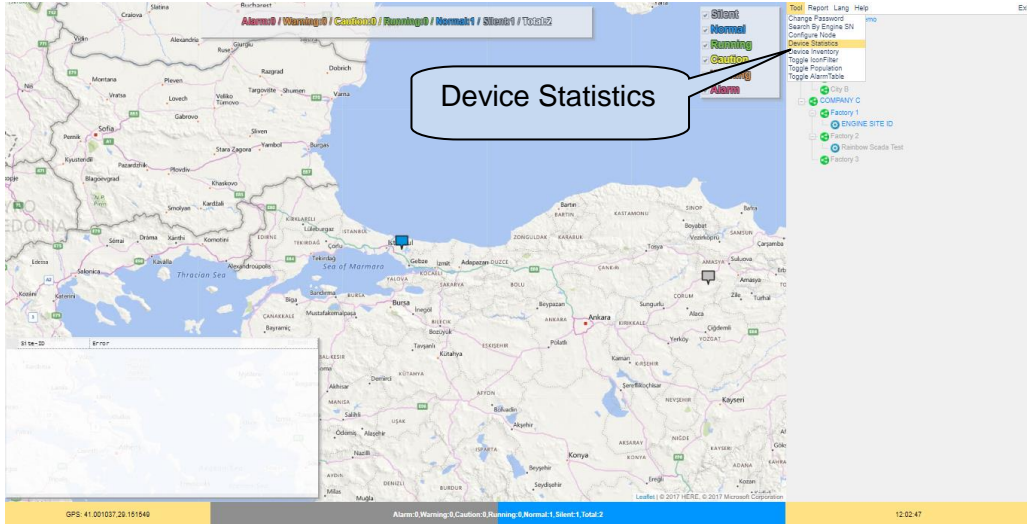

4.1.4 Device Inventory

Device Inventory tab under the **Tool** menu displays the number of devices linked with each node in detail. Click a node to display devices connected to it. After that, click **Tool**, and click **Device Inventory** tab.

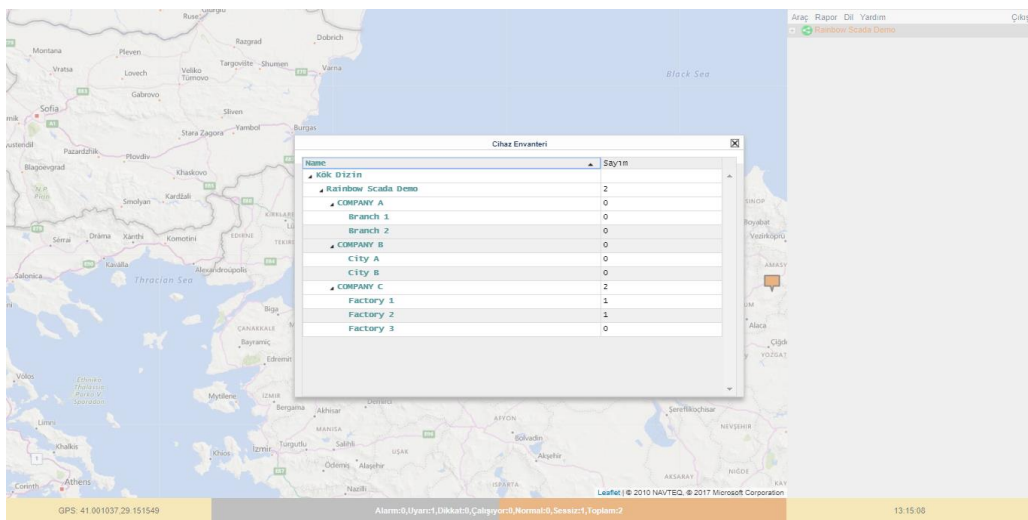
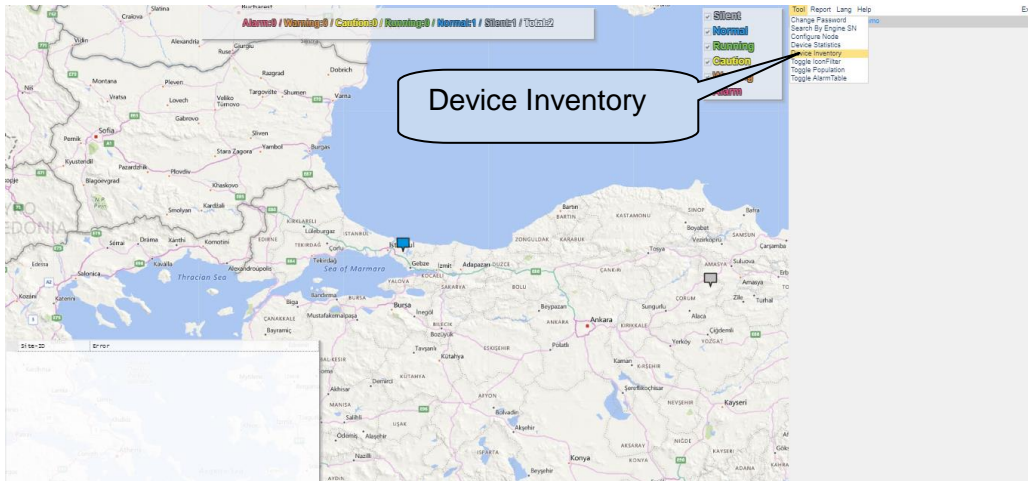

4.1.5 Toggle Icon Filter

Devices on remote monitoring system can be filtered with respect to their status providing ease of use. Filtered statuses are; alarm, warning, caution, silent, running, and normal. Filtering can be performed by clicking **toggle icon filter** under **tool** menu.

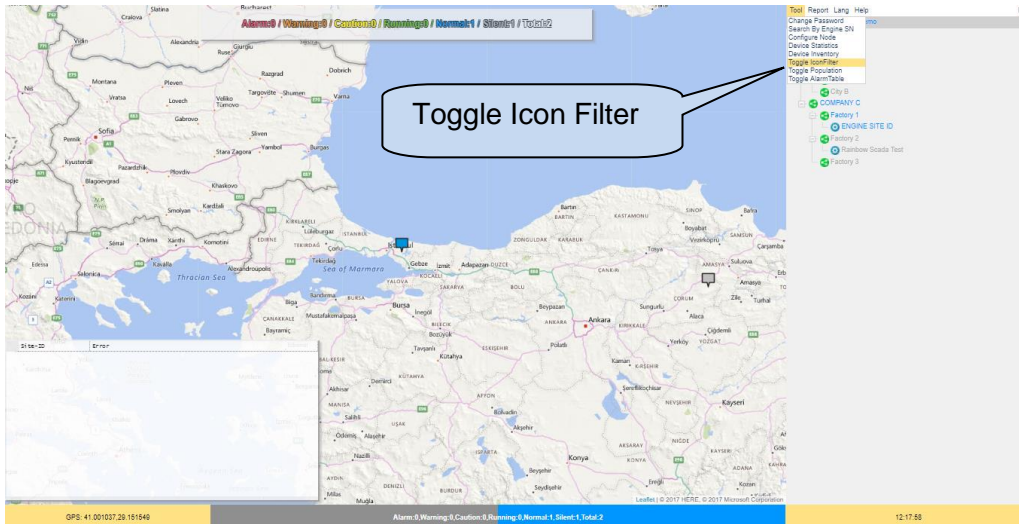

New window will appear allowing users to filter statuses of the devices. You can select statuses that you would like to filter. Only devices with selected statuses will be displayed on remote monitoring system.

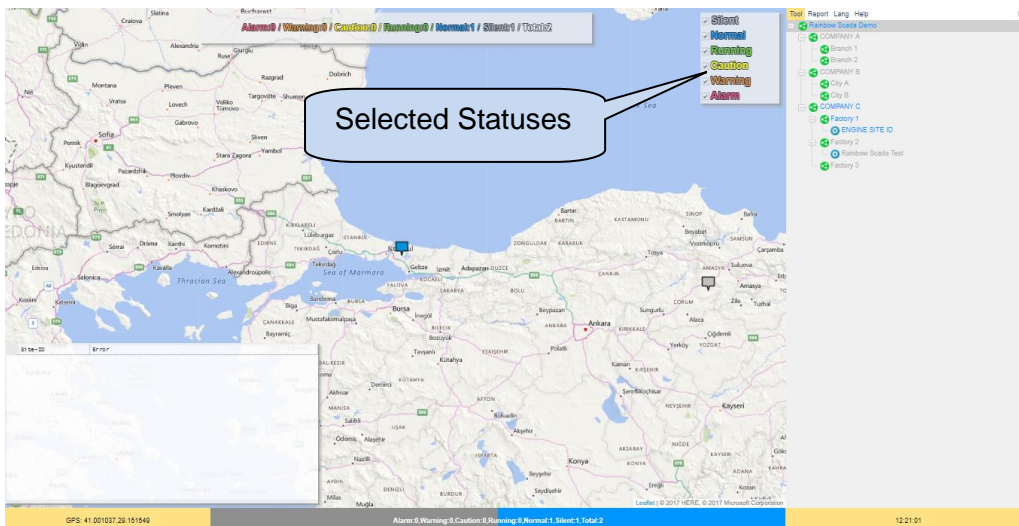

4.1.6 Toggle Population

Toggle Population tab under **tool** menu will create a new window on the remote monitoring system, which displays device population indicating their statuses.

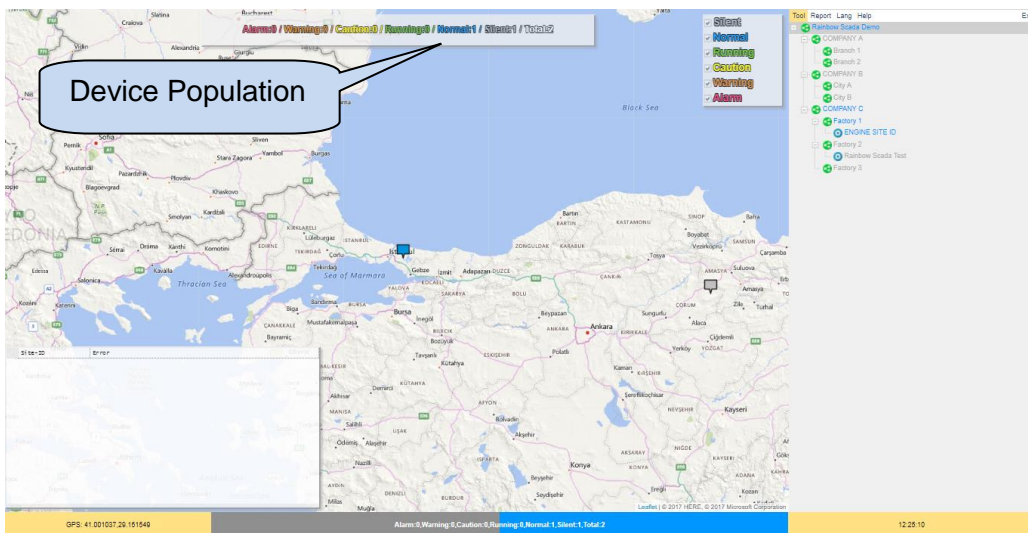
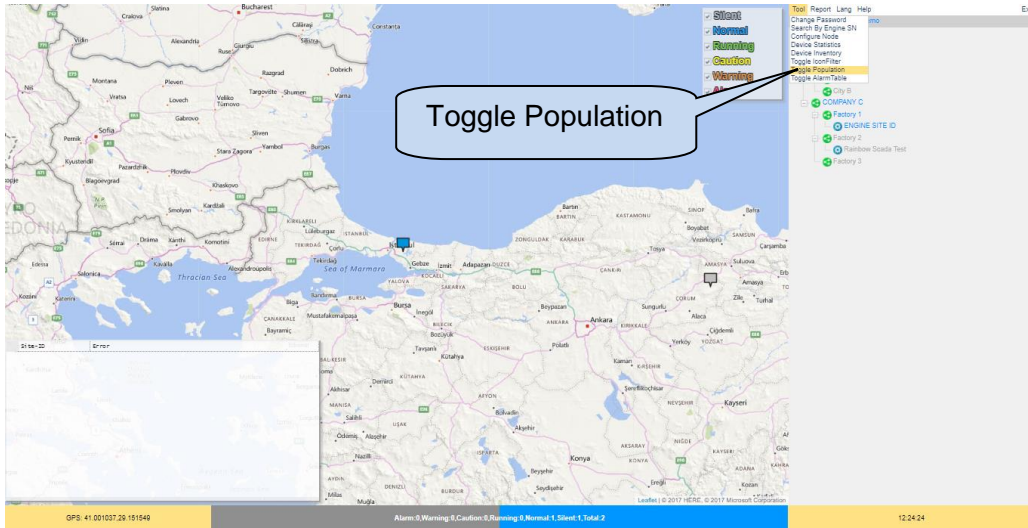

4.1.7 Toggle Alarm Table

Toggle Alarm Table tab under the **tool** menu will create a new window on the remote monitoring system, which has a list of alarms and warnings of all devices.

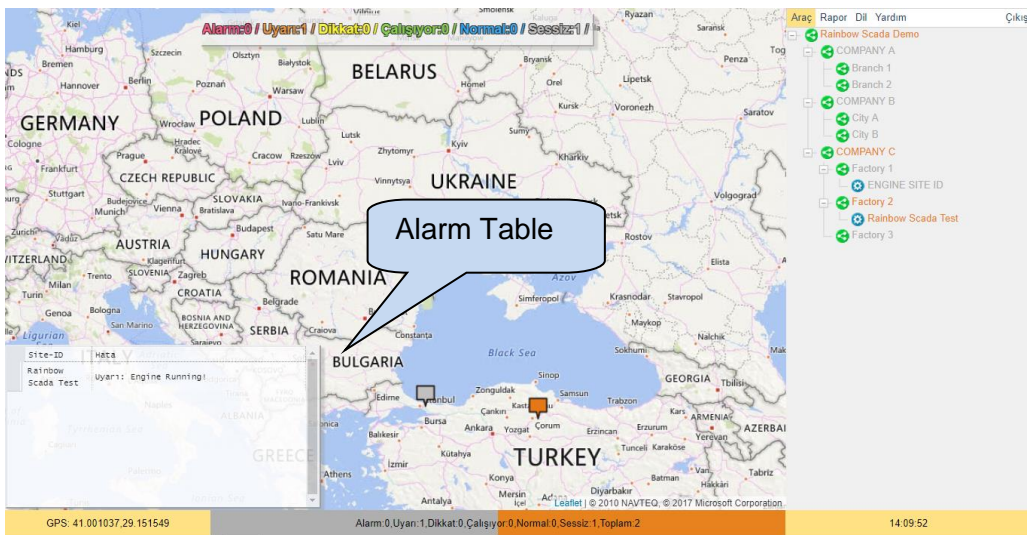
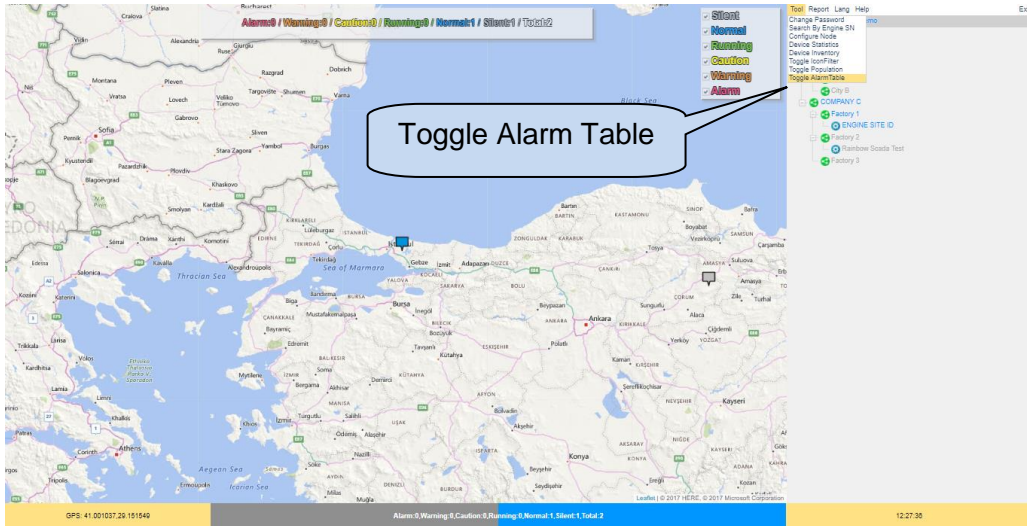

4.2. Report

4.2.1. Meter Report

If account has metering devices, click Meter Report to view measurements on one screen.

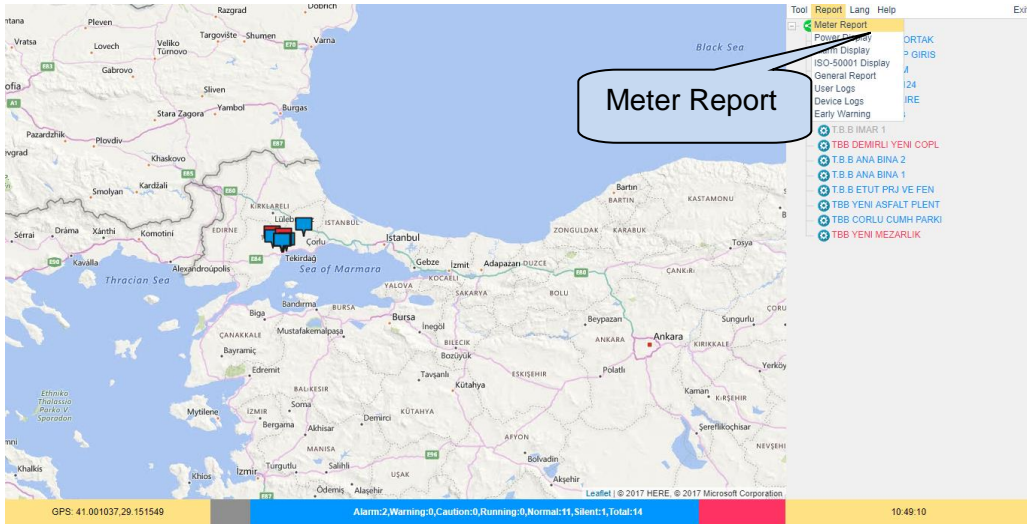

Inductive/capacitive percentages and kWh measurement are displayed on this screen.

Site Info	Serial NO	Status	Start Date	% Ind.	% Cap.	kwh
T. B. B İMAR 2 VE ORTAK	1234567890	NORMAL	Mon Jul 10 2017	0.4	1.8	2710.0
TBB SAHIL OZG P GIRIS	1234567890	NORMAL	Mon Jul 10 2017	0.1	0.1	10790.0
T. B. B BİLGİ İSLEM	1234567890	NORMAL	Mon Jul 10 2017	0.1	0.7	20690.0
DATAKOM/DFC0124	1234567890	NORMAL	Mon Jul 10 2017	0.2	0.0	11570.0
T. B. B ULASIM DAIRE	1234567890	NORMAL	Mon Jul 10 2017	1.1	4.0	17490.0
T. B. B ANA BINA 3	1234567890	NORMAL	Mon Jul 10 2017	1.4	0.0	15400.0
T. B. B İMAR 1	1234567890	WARNING	Mon Jul 10 2017	N/A	N/A	N/A
TBB DEMIRLI YENI COPL	1234567890	PENALTY	Mon Jul 10 2017	1.0	202.0	990.0
T. B. B ANA BINA 2	1234567890	NORMAL	Mon Jul 10 2017	1.1	0.6	8300.0
T. B. B ANA BINA 1	1234567890	NORMAL	Mon Jul 10 2017	1.4	0.3	8690.0
T. B. B ETUT PRJ VE FEN	1234567890	NORMAL	Mon Jul 10 2017	1.6	1.6	11220.0
TBB YENI ASFALT PLENT	1234567890	NORMAL	Mon Jul 10 2017	3.8	1.7	3460.0
TBB CORLU CUMH PARKI	1234567890	NORMAL	Mon Jul 10 2017	0.4	7.1	8180.0
TBB YENI MEZARLIK	1234567890	PENALTY	Mon Jul 10 2017	55.8	1.9	520.0

It will be easier to check reactive consumption by considering status column.

Site Info	Serial NO	Status	Start Date	% Ind.	% Cap.	kwh
T. B. B İMAR 2 VE ORTAK	1234567890	NORMAL	Mon Jul 10 2017	0.4	1.8	2710.0
TBB SAHIL OZG P GIRIS	1234567890	NORMAL	Mon Jul 10 2017	0.1	0.1	10790.0
T. B. B BİLGİ İSLEM	1234567890	NORMAL	Mon Jul 10 2017	0.1	0.7	20690.0
DATAKOM/DFC0124	1234567890	NORMAL	Mon Jul 10 2017	0.2	0.0	11570.0
T. B. B ULASIM DAIRE	1234567890	NORMAL	Mon Jul 10 2017	1.1	4.0	17490.0
T. B. B ANA BINA 3	1234567890	NORMAL	Mon Jul 10 2017	1.4	0.0	15400.0
T. B. B İMAR 1	1234567890	WARNING	Mon Jul 10 2017	N/A	N/A	N/A
TBB DEMIRLI YENI COPL	1234567890	PENALTY	Mon Jul 10 2017	1.0	202.0	990.0
T. B. B ANA BINA 2	1234567890	NORMAL	Mon Jul 10 2017	1.1	0.6	8300.0
T. B. B ANA BINA 1	1234567890	NORMAL	Mon Jul 10 2017	1.4	0.3	8690.0
T. B. B ETUT PRJ VE FEN	1234567890	NORMAL	Mon Jul 10 2017	1.6	1.6	11220.0
TBB YENI ASFALT PLENT	1234567890	NORMAL	Mon Jul 10 2017	3.8	1.7	3460.0
TBB CORLU CUMH PARKI	1234567890	NORMAL	Mon Jul 10 2017	0.4	7.1	8180.0
TBB YENI MEZARLIK	1234567890	PENALTY	Mon Jul 10 2017	55.8	1.9	520.0

Click time interval selections to scan reactive consumption within intervals.

Return Home Page Meter Report

Today Last 7 Days Last 31 Days **Time Interval** Save to File

Site Info	Serial NO	Status	Start Date	End Date	% Ind.	% Cap.	kwh
T.B.B İMAR 2 VE ORTAK	1234567890	NORMAL	Mon Jul 10 2017	Tue Jul 11 2017	0.4	1.8	2710.0
TBB SAHIL OZG P GIRIS	1234567890	NORMAL	Mon Jul 10 2017	Tue Jul 11 2017	0.1	0.1	10790.0
T.B.B BILGI ISLEM	1234567890	NORMAL	Mon Jul 10 2017	Tue Jul 11 2017	0.1	0.7	20690.0
DATAKOM/DFC0124	1234567890	NORMAL	Mon Jul 10 2017	Tue Jul 11 2017	0.2	0.0	11570.0
T.B.B ULASIM DAIRE	1234567890	NORMAL	Mon Jul 10 2017	Tue Jul 11 2017	1.1	4.0	17490.0
T.B.B ANA BINA 3	1234567890	NORMAL	Mon Jul 10 2017	Tue Jul 11 2017	1.4	0.0	15400.0
T.B.B İMAR 1	1234567890	WARNING	Mon Jul 10 2017	Tue Jul 11 2017	N/A	N/A	N/A
TBB DEMIRLI YENI COPL	1234567890	PENALTY	Mon Jul 10 2017	Tue Jul 11 2017	1.0	202.0	990.0
T.B.B ANA BINA 2	1234567890	NORMAL	Mon Jul 10 2017	Tue Jul 11 2017	1.1	0.6	8300.0
T.B.B ANA BINA 1	1234567890	NORMAL	Mon Jul 10 2017	Tue Jul 11 2017	1.4	0.3	8690.0
T.B.B ETUT PRJ VE FEN	1234567890	NORMAL	Mon Jul 10 2017	Tue Jul 11 2017	0.4	1.6	11220.0
TBB YENI ASFALT PLENT	1234567890	NORMAL	Mon Jul 10 2017	Tue Jul 11 2017	3.8	1.7	3460.0
TBB CORLU CUMH PARKI	1234567890	NORMAL	Mon Jul 10 2017	Tue Jul 11 2017	0.4	7.1	8180.0
TBB YENI MEZARLIK	1234567890	PENALTY	Mon Jul 10 2017	Tue Jul 11 2017	55.8	1.9	520.0

Click Save To File to save the report in .csv format.

Rainbow Scada - 25 x

Return Home Page Meter Report

Today Last 7 Days Last 31 Days This Month **Save to File** Save to File

Site Info	Serial NO	Status	Start Date	End Date	% Ind.	% Cap.	kwh
BAFRA	1234567890	WARNING	Tue Jun 03 2014	wed Jun 04 2014	N/A	N/A	N/A
karadeniz erk60031136	60031136	NORMAL	Tue Jun 03 2014	wed Jun 04 2014	3.0	7.1	35610.0
SINOP/KEFEVI MAH.	1234567890	NORMAL	Tue Jun 03 2014	wed Jun 04 2014	3.9	2.6	6890.0
SINOP NATO YOLU BBLOK	1234567890	NORMAL	Tue Jun 03 2014	wed Jun 04 2014	1.9	7.7	2070.0
SINOP NATO YOLU ABLOK	N/A	NORMAL	Tue Jun 03 2014	wed Jun 04 2014	4.4	7.4	2700.0
TOKAT MERKEZ B BLOK	N/A	PENALTY	Tue Jun 03 2014	wed Jun 04 2014	21.5	19.5	7070.0
carsamba yurt	N/A	WARNING	Tue Jun 03 2014	wed Jun 04 2014	N/A	N/A	N/A
ZILE BAKELIENLER MAH	N/A	WARNING	Tue Jun 03 2014	wed Jun 04 2014	N/A	N/A	N/A
TOKAT YURT A/B/C/D	1234567890	PENALTY	Tue Jun 03 2014	wed Jun 04 2014	27.9	8.6	40460.0
TOKAT MERKEZ A BLOK	N/A	WARNING	Tue Jun 03 2014	wed Jun 04 2014	12.2	7.1	5240.0
AMASYA YURT MUD.	70102234	WARNING	Tue Jun 03 2014	wed Jun 04 2014	N/A	N/A	N/A
600 EVLER KIZ YURDU	1234567890	WARNING	Tue Jun 03 2014	wed Jun 04 2014	11.0	1.7	6300.0
OSMANIYE/E BLOK	N/A	NORMAL	Tue Jun 03 2014	wed Jun 04 2014	2.4	0.5	6340.0
AMASYA YESILIRMAK/A	50049278	WARNING	Tue Jun 03 2014	wed Jun 04 2014	N/A	N/A	N/A
YESILIRMAK B BLOK	1234567890	WARNING	Tue Jun 03 2014	wed Jun 04 2014	N/A	N/A	N/A
MERZIFON KIZ A BLOK	1234567890	WARNING	Tue Jun 03 2014	wed Jun 04 2014	N/A	N/A	N/A
IBNI KEHAL	1234567890	WARNING	Tue Jun 03 2014	wed Jun 04 2014	N/A	N/A	N/A
TURHAL	1234567890	WARNING	Tue Jun 03 2014	wed Jun 04 2014	6.3	8.9	2690.0
carsamba sungur1u mh	N/A	WARNING	Tue Jun 03 2014	wed Jun 04 2014	N/A	N/A	N/A
D001-409 (C)	N/A	WARNING	Tue Jun 03 2014	wed Jun 04 2014	N/A	N/A	0.0

Download

ozenelektrik_2014_06...csv

Click Return Home Page for the main screen.

Return Home Page Meter Report

Today Last 7 Days Last 31 Days This Month **Return Home Page** Save to File

Site Info	Serial NO	Status	Start Date	End Date	% Ind.	% Cap.	kwh
T.B.B İMAR 2 VE ORTAK	1234567890	NORMAL	Mon Jul 10 2017	Tue Jul 11 2017	0.4	1.8	2710.0
TBB SAHIL OZG P GIRIS	1234567890	NORMAL	Mon Jul 10 2017	Tue Jul 11 2017	0.1	0.1	10790.0
T.B.B BILGI ISLEM	1234567890	NORMAL	Mon Jul 10 2017	Tue Jul 11 2017	0.1	0.7	20690.0
DATAKOM/DFC0124	1234567890	NORMAL	Mon Jul 10 2017	Tue Jul 11 2017	0.2	0.0	11570.0
T.B.B ULASIM DAIRE	1234567890	NORMAL	Mon Jul 10 2017	Tue Jul 11 2017	1.1	4.0	17490.0
T.B.B ANA BINA 3	1234567890	NORMAL	Mon Jul 10 2017	Tue Jul 11 2017	1.4	0.0	15400.0
T.B.B İMAR 1	1234567890	WARNING	Mon Jul 10 2017	Tue Jul 11 2017	N/A	N/A	N/A
TBB DEMIRLI YENI COPL	1234567890	PENALTY	Mon Jul 10 2017	Tue Jul 11 2017	1.0	202.0	990.0
T.B.B ANA BINA 2	1234567890	NORMAL	Mon Jul 10 2017	Tue Jul 11 2017	1.1	0.6	8300.0
T.B.B ANA BINA 1	1234567890	NORMAL	Mon Jul 10 2017	Tue Jul 11 2017	1.4	0.3	8690.0
T.B.B ETUT PRJ VE FEN	1234567890	NORMAL	Mon Jul 10 2017	Tue Jul 11 2017	0.4	1.6	11220.0
TBB YENI ASFALT PLENT	1234567890	NORMAL	Mon Jul 10 2017	Tue Jul 11 2017	3.8	1.7	3460.0
TBB CORLU CUMH PARKI	1234567890	NORMAL	Mon Jul 10 2017	Tue Jul 11 2017	0.4	7.1	8180.0
TBB YENI MEZARLIK	1234567890	PENALTY	Mon Jul 10 2017	Tue Jul 11 2017	55.8	1.9	520.0

4.2.2. Power Display

Power Display screen reports voltage, current and power measurements in detail related with each node. Therefore, if more than one device is connected to a node, total power consumption can be monitored easily.

Name	Power - P Total (kW)	Power - Q Total (kVar)	Power - S Total (kVA)
RootNode	255.8	-4.6	264.5
Tekirdag Belediyesi	255.8	-4.6	264.5
T. B. B İMAR 2 VE ORTAK	3.6	0.0	3.9
TBB SAHİL OZG P GIRIS	8.4	0.0	9.3
T. B. B BILGI İSLEM	40.0	0.1	40.3
DATAKOM/DFCO124	20.5	0.1	20.6
T. B. B ULASTIM DAİRE	51.6	-1.3	51.9
T. B. B ANA BİNA 3	40.1	0.0	40.8
T. B. B İMAR 1	3.5	-0.0	3.7
TBB DEMIRLI YENI COPL	0.3	-3.9	4.0
T. B. B ANA BİNA 2	18.4	0.3	19.1
T. B. B ANA BİNA 1	22.1	0.0	22.7
T. B. B ETUT PRJ VE FEN	33.3	0.0	33.6
TBB YENI ASFALT PLENT	13.0	0.0	13.0
TBB CORLU CUMH PARKI	0.3	0.0	1.1
TBB YENI MEZARLIK	0.4	0.3	0.6

Nodes can be expanded or collapsed by clicking **View Menu** by **Expand All**, and **Collapse All** options.

Name	Power - P Total (kW)	Power - Q Total (kVar)	Power - S Total (kVA)
RootNode	255.8	-4.6	264.5
Tekirdag Belediyesi	255.8	-4.6	264.5
T. B. B İMAR 2 VE ORTAK	3.6	0.0	3.9
TBB SAHİL OZG P GIRIS	8.4	0.0	9.3
T. B. B BILGI İSLEM	40.0	0.1	40.3
DATAKOM/DFCO124	20.5	0.1	20.6
T. B. B ULASTIM DAİRE	51.6	-1.3	51.9
T. B. B ANA BİNA 3	40.1	0.0	40.8
T. B. B İMAR 1	3.5	-0.0	3.7
TBB DEMIRLI YENI COPL	0.3	-3.9	4.0
T. B. B ANA BİNA 2	18.4	0.3	19.1
T. B. B ANA BİNA 1	22.1	0.0	22.7
T. B. B ETUT PRJ VE FEN	33.3	0.0	33.6
TBB YENI ASFALT PLENT	13.0	0.0	13.0
TBB CORLU CUMH PARKI	0.3	0.0	1.1
TBB YENI MEZARLIK	0.4	0.3	0.6

Power display screen is also configurable. Click **Tool** and then click **Configure View**. Values displayed on the **Power Display Screen** can be configured one by one.

Configure View	Power - P Total (kW)	Power - Q Total (kVAr)	Power - S Total (kVA)
RootNode	237.7	-4.1	247.0
Tekirdag Belediyesi	237.7	-4.1	247.0
T.B.B IMAR 2 VE	3.4	0.0	3.7
TBB SAHIL OZG P	8.3	0.0	9.2
T.B.B BILGI ISLEM	39.4	0.0	39.7
DATAKOM/DFCO124	20.5	0.1	20.6
T.B.B ULASIM DAIRE	46.1	-1.5	46.5
T.B.B ANA BINA 3	43.1	0.0	43.7
T.B.B IMAR 1	3.5	-0.0	3.7
TBB DEMIRLI YENI COPL	0.2	-4.0	4.1
T.B.B ANA BINA 2	19.0	0.6	19.7
T.B.B ANA BINA 1	17.2	0.4	17.9
T.B.B ETUT PRJ VE FEN	30.7	0.0	30.9
TBB YENI ASFALT PLENT	4.9	0.0	5.2
TBB CORLU CUMH PARKI	0.3	0.0	1.1
TBB YENI MEZARLIK	1.0	0.3	1.1

View Configuration screen will be seen below. You can configure column values on this screen.

View Configuration [X]

Column Value - 1: Power - P Total (kW)

Column Value - 2: Power - Q Total (kVAr)

Column Value - 3: Power - S Total (kVA)

Column Value - 4: -

Column Value - 5: -

Column Value - 6: Genset - V1 (V)

Column Value - 7: Genset - V2 (V)

Column Value - 8: Genset - V3 (V)

Column Value - 8: Genset - U1 (V)

Column Value - 9: Genset - U2 (V)

Genset - U3 (V)

Genset - I1 (A)

Genset - I2 (A)

Genset - I3 (A)

Power - P Total (kW)

Power - Q Total (kVAr)

Power - S Total (kVA)

Power - P1 (kW)

Power - P2 (kW)

Power - P3 (kW)

Power - Q1 (kVAr)

Power - Q2 (kVAr)

Power - Q3 (kVAr)

Power - S1 (kVA)

Power - S2 (kVA)

Click **Save** button to save the configuration.

Click **Go Back** for the main screen.

Name	Power - P Total (kW)	Power - Q Total (kVAr)	Power - S Total (kVA)
RootNode	247.9	-0.7	257.0
Tekirdag Belediyesi	247.9	-0.7	257.0
T.B.B IMAR 2 VE ORTAK	6.5	0.0	6.7
TBB SAHIL OZG P GIRIS	10.1	0.0	10.9
T.B.B BILGI ISLEM	40.7	0.1	41.0
DATAKOM/DFCO124	20.5	0.1	20.6
T.B.B ULASIM DAIRE	45.3	-0.3	45.6
T.B.B ANA BINA 3	43.7	0.0	44.2
T.B.B IMAR 1	3.5	-0.0	3.7
TBB DEMIRLI YENI COPL	0.3	-4.1	4.1
T.B.B ANA BINA 2	23.6	1.8	24.2
T.B.B ANA BINA 1	21.9	1.5	22.4
T.B.B ETUT PRJ VE FEN	25.7	0.0	26.0
TBB YENI ASFALT PLENT	4.6	0.0	5.3
TBB CORLU CUMH PARKI	0.3	0.0	1.1
TBB YENI MEZARLIK	1.2	0.3	1.3

4.2.3. Alarm Display

Alarm display screen reports all existing alarms and warnings on one screen.

Click **Report** and click **Alarm Display**.



Alarm display screen will be displayed ;

Time	Site-ID	Unique-ID	Version	Error
2014-06-09T05:55:58Z	TASKOPRU TEPE	1FF0FF0B6498D4FEC2F6750	DK05D500	Shutdown: Low Battery voltage; warning: Low Battery voltage
2014-06-09T05:47:40Z	DATCAMESUDİYEKND0 SYOL	01B00009291CD4F2F2C61	DK05D500	warning: Service 1 Request
2014-06-09T05:44:03Z	TURKCELL_CALTEPE	0F0DFF0F02A1D0AF78B6C50	DK05D500	warning: Service 1 Request
2014-06-09T05:44:03Z	BİTLİS/DİDEBAN/TR T	1A4001066498D4F72FF6650	DK05D500	warning: Kabin kaptı acık
2014-06-09T05:44:03Z	KARAHALKKA-KOYU	01A000056498D4F76F86650	DK05D500	warning: Service 1 Request
2014-06-09T05:44:03Z	KARGİPİNAR-YENİ	145001056498D4F4F96650	DK05D500	warning: Service 1 Request
2014-06-09T05:44:03Z	EREGLİ/OREN	1640FF0B291CD4F543D61	DK05D500	warning: Service 1 Request
2014-06-09T05:44:03Z	HATAY SAMANDAG YOLU	1D10010A291CD4F173361	DK05D500	warning: Fail To Stop
2014-06-09T05:44:03Z	KARAKOC	093000056498D4F72FA6650	DK05D500	warning: Service 1 Request
2014-06-09T05:44:03Z	ORMANLI/HALASLI	0FF00003291CD4FA80661	DK05D500	warning: Service 1 Request
2014-06-09T05:44:03Z	KAYMAKLI/GOZTEPE	003000026498D4F74E76650	DK05D500	warning: Service 1 Request

Alarm list can be sorted by Time, Alarm level & Time.

The screenshot shows the same alarm list table as above, but with a 'Sort By Time' callout pointing to the 'Time' column header and a 'Sort by Alarm & Time' callout pointing to the 'Error' column header. The table content is identical to the previous one.

Shutdown alarms will be red, warnings will be yellow. Click **Go Back** to the main screen.

Time	Site-ID	Unique-ID	Version	Error
2014-06-09T05:55:58Z	TASKOPRU TEPE	1FF0FF066498D4AFEC2F6750	DK05D500	Shutdown: Low Battery voltage; warning: Low Battery voltage
2014-06-09T05:47:40Z	...	01800009291CD4AF2F2C6150	DK05D500	warning: Service 1 Request
2014-06-09T05:44:03Z	...	02A1D00AF78B61C050	DK05D500	warning: Service 1 Request
2014-06-09T05:44:03Z	...	6498D4AF72FF66050	DK05D500	warning: Kabin kapsi acik
2014-06-09T05:44:03Z	...	6498D4AF76F866050	DK05D500	warning: Service 1 Request
2014-06-09T05:44:03Z	KARGIPINAR-YENI	115001056498D4AF4A96050	DK05D500	warning: Service 1 Request
2014-06-09T05:44:03Z	...	01CD4AF543D61050	DK05D500	warning: Service 1 Request
2014-06-09T05:44:03Z	HA...	0CD4AF173361050	DK05D500	warning: Fail To Stop
2014-06-09T05:44:03Z	KA...	98D4AF72FA66050	DK05D500	warning: Service 1 Request
2014-06-09T05:44:03Z	ORM...	OFF00003291CD4AF80661050	DK05D500	warning: Service 1 Request
2014-06-09T05:44:03Z	KAYMAKLI/GOZTEPE	003000026498D4AF74E766050	DK05D500	warning: Service 1 Request
2014-06-09T05:44:03Z	BINGOL/YEDISU	0E0315158D014D531E74F04D	DK04D500	warning: Fail To Stop
2014-06-09T05:44:03Z	CAMLARCA KOYU	0960FF056498D4AF4AFC66050	DK05D500	warning: Fail To Stop, Reverse Power

4.2.4. General Report

General Report tab under the **Report** menu will create a list of measured parameters between specified dates.

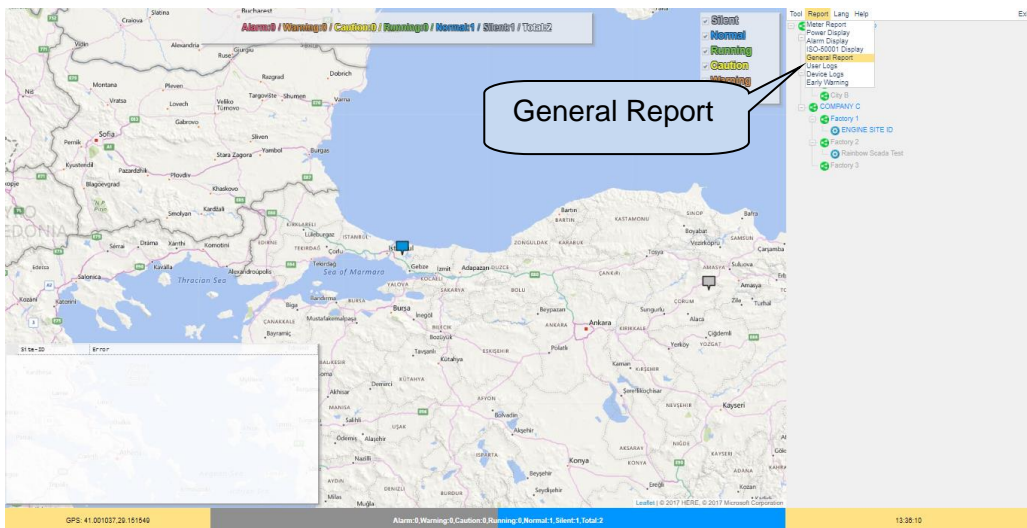

A new window will appear asking users to configure the time interval as well as measurements to be listed.

Help | 27.08.2017 00:00:00 | 29.08.2017 00:00:00 | Battery Volt | Query | Save

Engine Temp
Fuel Percent (%)
Fuel Amount (kgal)
Fuel Consumption (kgal)
Total kWh
Rainbow Scada Demo

- COMPANY A
 - Branch 1
 - Branch 2
- COMPANY B
 - City A
 - City B
- COMPANY C
 - Factory 1
 - Factory 2
 - Factory 3

Time interval

Measurements to be listed

Help | 27.08.2017 00:00:00 | 29.08.2017 00:00:00 | Engine Temp | Query | Save

Engine Temp
List
Difference
Minimum
Maximum
Average
Fuel Consumption

Query type

Query

Baş: 24.08.2017 00:00:00 | Son: 26.08.2017 00:00:00 | Sorgula | Kaydet

Name	Aku Voltajı - Ortalama	Toplam kWh - Maksimum	Motor Çalışma Saati - Fark	Motor Sıcaklığı - Ortalama
▲ kök dizin		74.80	37.97	
▲ Rainbow Scada Demo		74.80	37.97	
▲ COMPANY A				
Branch 1				
Branch 2				
▲ COMPANY B				
City A				
City B				
▲ COMPANY C		74.80	37.97	
▶ Factory 1		0.00	0.00	
▲ Factory 2		74.80	37.97	
Rainbow Scada Test (123456789)	13.50	74.80	37.97	N/A
Factory 3				

Listed parameters

4.2.5 User Logs

User Logs tab under the Report menu will create a list of user logs with date and time stamps.

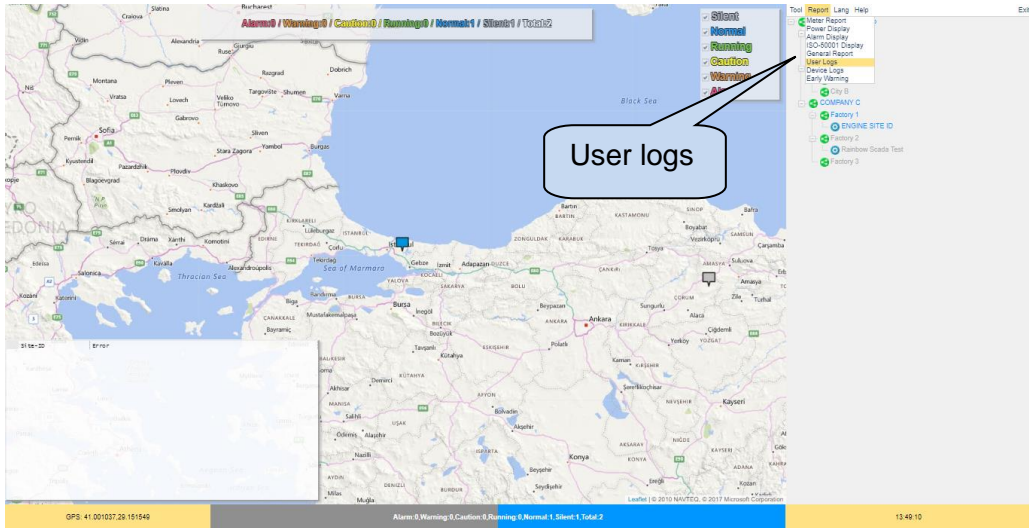

In order to list user logs, time interval, customer and user must be specified.

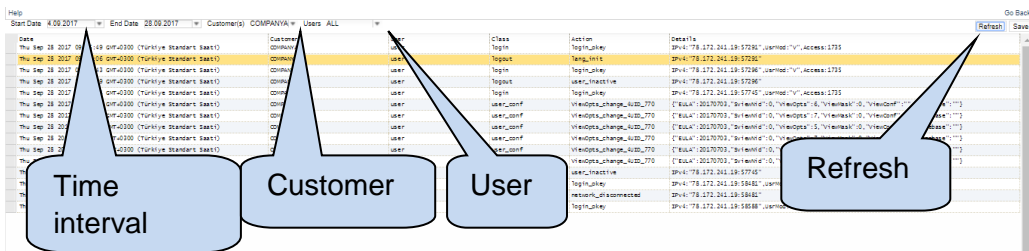

4.2.6 Device Logs

Rainbow Scada logs status changes of each device connected to remote monitoring system. **Device Logs** tab under **Report** menu will create a list of status changes of remotely monitored devices.

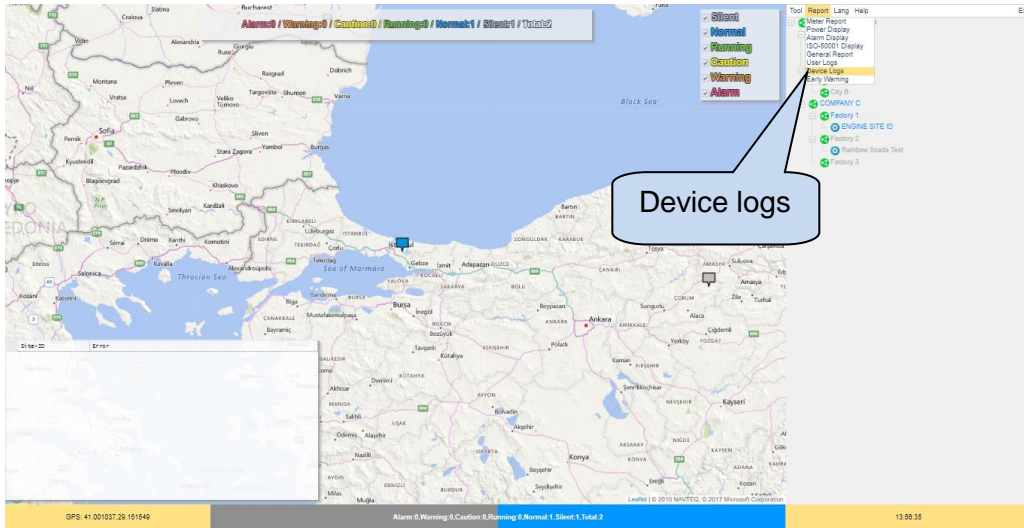

In order to list device logs, time interval, customer and devices must be specified.

Tarih	İçerik	Çihaz	Çihaz Adı	Köle	Çevrimiçi	Hicbiri
Tue Nov 08 2016 07:43	QIHT+0300 (Türkiye Standart Saat)	647699	FLORA	TEKNE	["S"] ["I"]	Fail to Start ["L"] ["I"] ["W"] ["I"]
Tue Nov 08 2016 09:10	QIHT+0300 (Türkiye Standart Saat)	647699	FLORA	TEKNE	["S"] ["I"]	Fail to Start ["L"] ["I"] ["W"] ["I"]
Tue Nov 08 2016 16:20	QIHT+0300 (Türkiye Standart Saat)	647699	FLORA	TEKNE	["S"] ["I"]	Fail to Start ["L"] ["I"] ["W"] ["I"]
Thu Nov 10 2016 00:01	QIHT+0300 (Türkiye Standart Saat)	647699	FLORA	TEKNE	["S"] ["I"]	Fail to Start ["L"] ["I"] ["W"] ["I"]
Thu Nov 10 2016 04:01	QIHT+0300 (Türkiye Standart Saat)	647699	FLORA	TEKNE	["S"] ["I"]	Fail to Start ["L"] ["I"] ["W"] ["I"]
Thu Nov 10 2016 08:01	QIHT+0300 (Türkiye Standart Saat)	647699	FLORA	TEKNE	["S"] ["I"]	Fail to Start ["L"] ["I"] ["W"] ["I"]
Thu Nov 10 2016 12:01	QIHT+0300 (Türkiye Standart Saat)	647699	FLORA	TEKNE	["S"] ["I"]	Fail to Start ["L"] ["I"] ["W"] ["I"]
Thu Nov 10 2016 16:01	QIHT+0300 (Türkiye Standart Saat)	647699	FLORA	TEKNE	["S"] ["I"]	Fail to Start ["L"] ["I"] ["W"] ["I"]
Fri Nov 11 2016 00:01	QIHT+0300 (Türkiye Standart Saat)	647699	FLORA	TEKNE	["S"] ["I"]	Fail to Start ["L"] ["I"] ["W"] ["I"]
Fri Nov 11 2016 04:01	QIHT+0300 (Türkiye Standart Saat)	647699	FLORA	TEKNE	["S"] ["I"]	Fail to Start ["L"] ["I"] ["W"] ["I"]
Fri Nov 11 2016 08:01	QIHT+0300 (Türkiye Standart Saat)	647699	FLORA	TEKNE	["S"] ["I"]	Fail to Start ["L"] ["I"] ["W"] ["I"]
Fri Nov 11 2016 12:01	QIHT+0300 (Türkiye Standart Saat)	647699	FLORA	TEKNE	["S"] ["I"]	Fail to Start ["L"] ["I"] ["W"] ["I"]
Fri Nov 11 2016 16:01	QIHT+0300 (Türkiye Standart Saat)	647699	FLORA	TEKNE	["S"] ["I"]	Fail to Start ["L"] ["I"] ["W"] ["I"]
Sat Nov 12 2016 00:01:41	QIHT+0300 (Türkiye Standart Saat)	647699	FLORA	TEKNE	["S"] ["I"]	Fail to Start ["L"] ["I"] ["W"] ["I"]
Sat Nov 12 2016 00:14:27	QIHT+0300 (Türkiye Standart Saat)	647699	FLORA	TEKNE	["S"] ["I"]	Fail to Start ["L"] ["I"] ["W"] ["I"]
Sat Nov 12 2016 00:16:35	QIHT+0300 (Türkiye Standart Saat)	647699	FLORA	TEKNE	["S"] ["I"]	Fail to Start ["L"] ["I"] ["W"] ["I"]
Sat Nov 12 2016 02:18:07	QIHT+0300 (Türkiye Standart Saat)	647699	FLORA	TEKNE	["S"] ["I"]	Fail to Start ["L"] ["I"] ["W"] ["I"]
Sat Nov 12 2016 03:19:18	QIHT+0300 (Türkiye Standart Saat)	647699	FLORA	TEKNE	["S"] ["I"]	Fail to Start ["L"] ["I"] ["W"] ["I"]
Sat Nov 12 2016 03:26:26	QIHT+0300 (Türkiye Standart Saat)	647699	FLORA	TEKNE	["S"] ["I"]	Fail to Start ["L"] ["I"] ["W"] ["I"]
Sat Nov 12 2016 03:29:36	QIHT+0300 (Türkiye Standart Saat)	647699	FLORA	TEKNE	["S"] ["I"]	Fail to Start ["L"] ["I"] ["W"] ["I"]
Sat Nov 12 2016 03:44:46	QIHT+0300 (Türkiye Standart Saat)	647699	FLORA	TEKNE	["S"] ["I"]	Fail to Start ["L"] ["I"] ["W"] ["I"]
Sat Nov 12 2016 04:08:10	QIHT+0300 (Türkiye Standart Saat)	647699	FLORA	TEKNE	["S"] ["I"]	Fail to Start ["L"] ["I"] ["W"] ["I"]
Sat Nov 12 2016 05:12:13	QIHT+0300 (Türkiye Standart Saat)	647699	FLORA	TEKNE	["S"] ["I"]	Fail to Start ["L"] ["I"] ["W"] ["I"]
Sat Nov 12 2016 06:12:06	QIHT+0300 (Türkiye Standart Saat)	647699	FLORA	TEKNE	["S"] ["I"]	Fail to Start ["L"] ["I"] ["W"] ["I"]
Sat Nov 12 2016 06:16:10	QIHT+0300 (Türkiye Standart Saat)	647699	FLORA	TEKNE	["S"] ["I"]	Fail to Start ["L"] ["I"] ["W"] ["I"]
Sat Nov 12 2016 06:46:22	QIHT+0300 (Türkiye Standart Saat)	647699	FLORA	TEKNE	["S"] ["I"]	Fail to Start ["L"] ["I"] ["W"] ["I"]
Sat Nov 12 2016 16:16:05	QIHT+0300 (Türkiye Standart Saat)	647699	FLORA	TEKNE	["S"] ["I"]	Fail to Start ["L"] ["I"] ["W"] ["I"]
Sat Nov 12 2016 16:20:17	QIHT+0300 (Türkiye Standart Saat)	647699	FLORA	TEKNE	["S"] ["I"]	Fail to Start ["L"] ["I"] ["W"] ["I"]
Mon Nov 14 2016 07:19:14	QIHT+0300 (Türkiye Standart Saat)	647699	FLORA	TEKNE	["S"] ["I"]	Fail to Start ["L"] ["I"] ["W"] ["I"]
Mon Nov 14 2016 10:02:17	QIHT+0300 (Türkiye Standart Saat)	647699	FLORA	TEKNE	["S"] ["I"]	Fail to Start ["L"] ["I"] ["W"] ["I"]

4.2.7 Early Warning

Early Warning tab under **Report** menu allows user to filter remotely monitored devices with respect to measured parameters such as battery life, fuel level, maintenance time. Screenshot below shows devices that have less than 50% fuel left.

Cihaz ID	Site ID	Yakıt Seviyesi	Dosyaya Kaydet
2587	ILGAZ CUM. 855	0.00	
7588	KIRSEHIR CUMM NTT855	27.40	
8014	SIVRIHISAR KTA 19	48.20	
8617	ASTANONU DEUTZ	58.40	

Similarly, it is also possible to create a list with respect to maintenance timer.

Cihaz ID	Site ID	Önceki Servis Tarihi	Servis'e kalan Saat	Servis'e kalan Gün	Sonraki Servis Tarihi	Dosyaya Kaydet
3170	KARSEKİ NITTA 855	Wed Apr 05 2017 10:18:52 GMT+0300 (Türkiye Standart Saati)	230.61	-22.20	Thu Aug 03 2017 10:18:52 GMT+0300 (Türkiye Standart Saati)	
7588	KIRSEHIR CUMM NTT855	Wed May 03 2017 04:13:52 GMT+0300 (Türkiye Standart Saati)	225.40	5.65	Thu Aug 31 2017 04:13:52 GMT+0300 (Türkiye Standart Saati)	

4.3. Language Selection

Rainbow Scada supports multiple languages including Turkish, English, Spanish, French and Chinese.

Click **Language** and change language of Rainbow Scada if necessary.



It is required to log-out and log-in again the remote monitoring account in order to reflect the language change. Click **yes** for automatic log out from the account.

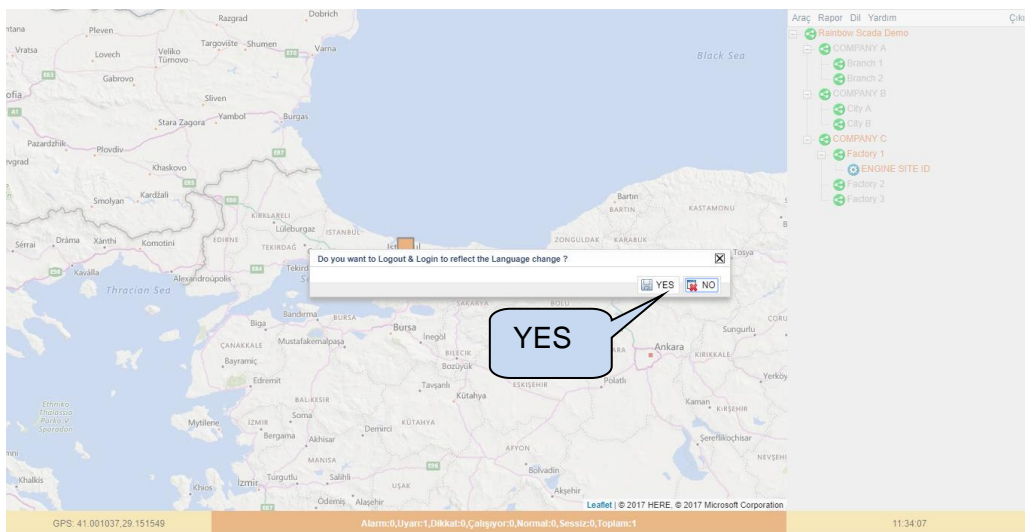

5. CONFIG SCADA

5.1. Overview

Config Scada is a feature supported by Rainbow Scada that allows users to design their unique and customized remote monitoring screens. Config Scada provides flexibility to the user allowing to build custom remote monitoring screens with many different devices.

5.2. Config Scada Login

In order to enable **Config Scada** feature, choose required node, click **Tool** and click **Configure Scada**.



Configure Scada will be initialized on monitoring mode. Therefore, only monitoring will be enabled on the screen below. If there are no remote monitoring screen configured before, an empty screen will be opened as shown below;

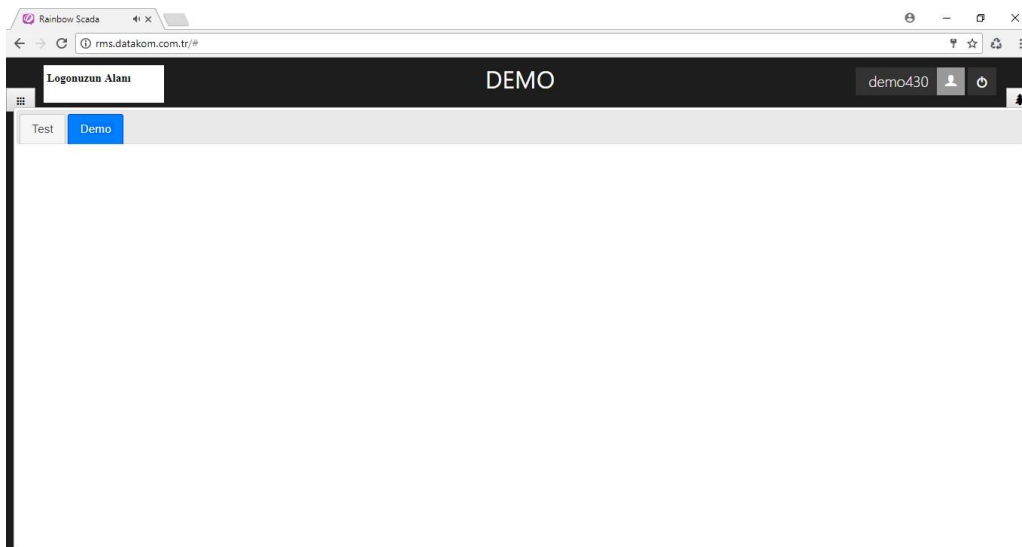

5.3. Config Mode

5.3.1 Config Mode Enable

Click  button on the left hand side of the screen to form up (or change) remote monitoring screen.

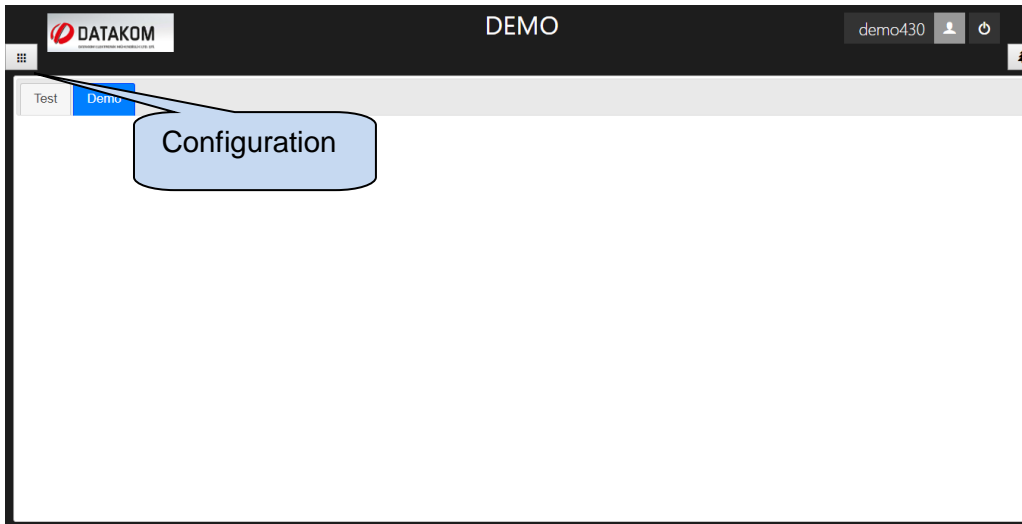

A new window will be displayed at the left hand side of the screen. Click  button.

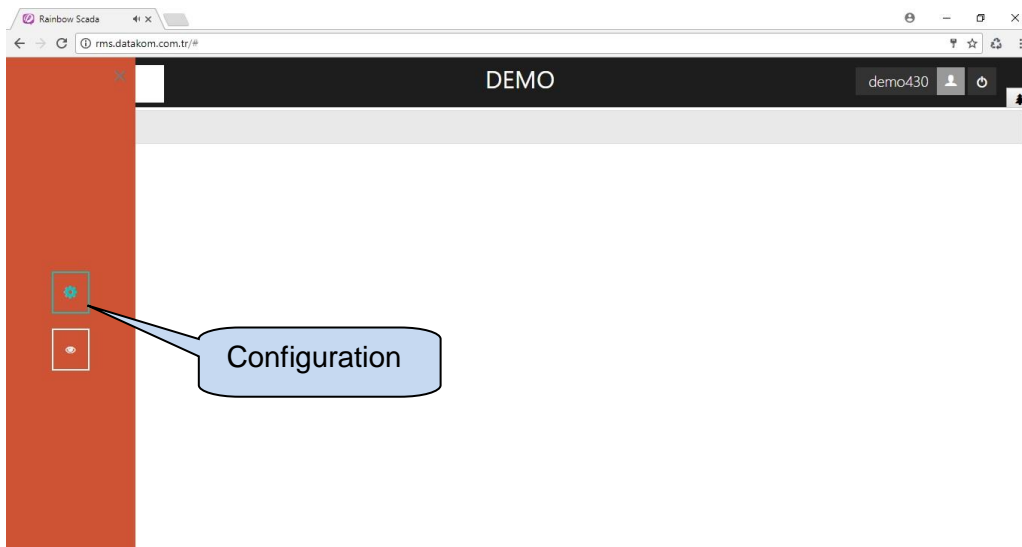

Below screen will be displayed once configuration mode is enabled.

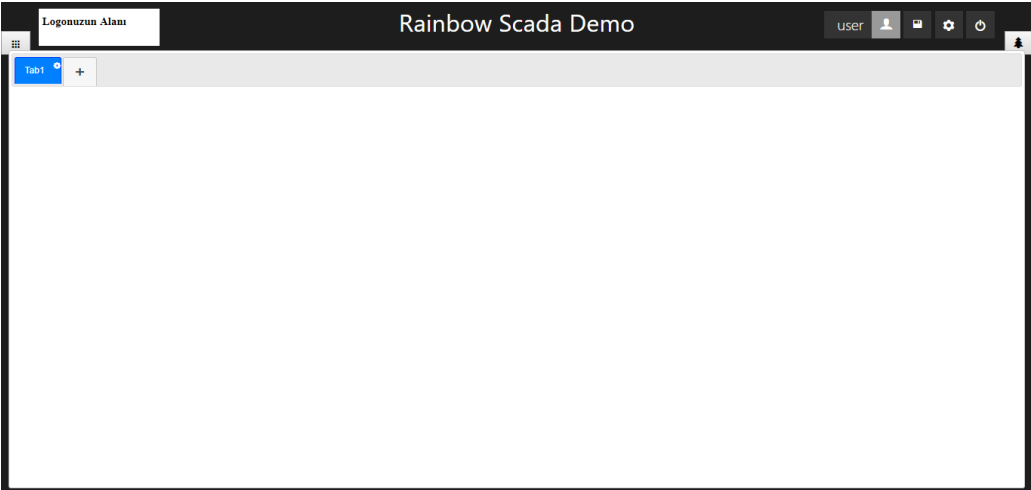

5.3.2 Save Changes

After each change made on the remote monitoring screen, it is required to save changes.

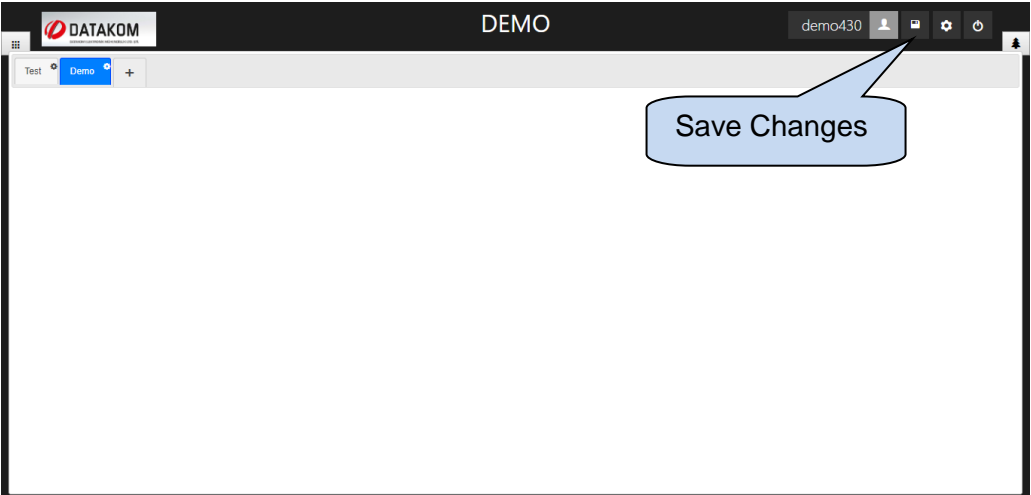

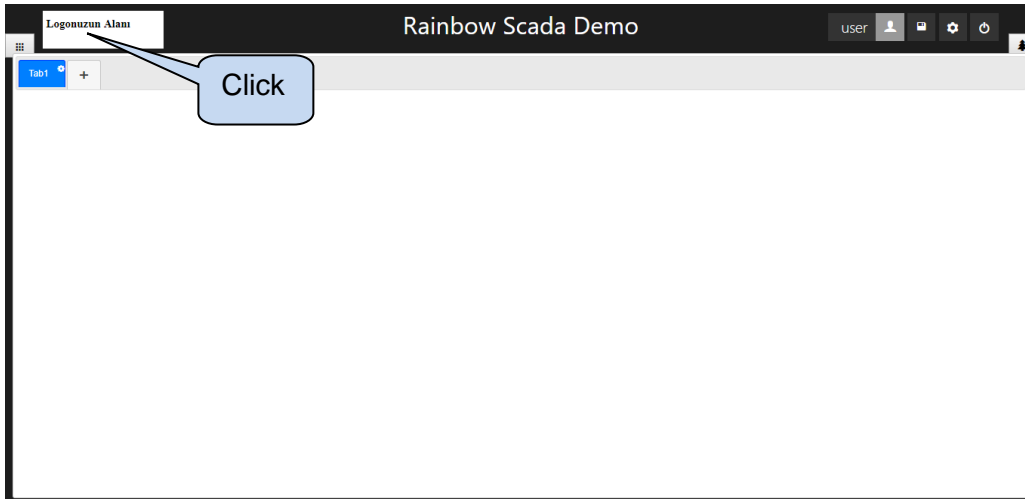

5.3.3 Logo Upload

It is possible to upload a logo for the remote monitoring screen. You should click to the logo zone, which is placed at the top left corner of the screen.

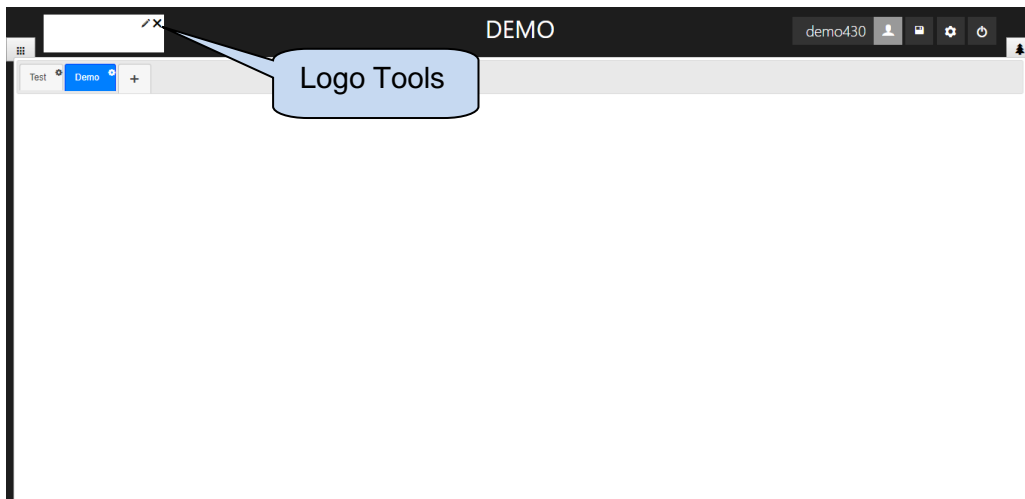

Tools will be displayed on the right hand side of the logo section.



Click  button to remove existing logo if there is any. Click  button to upload a new logo.

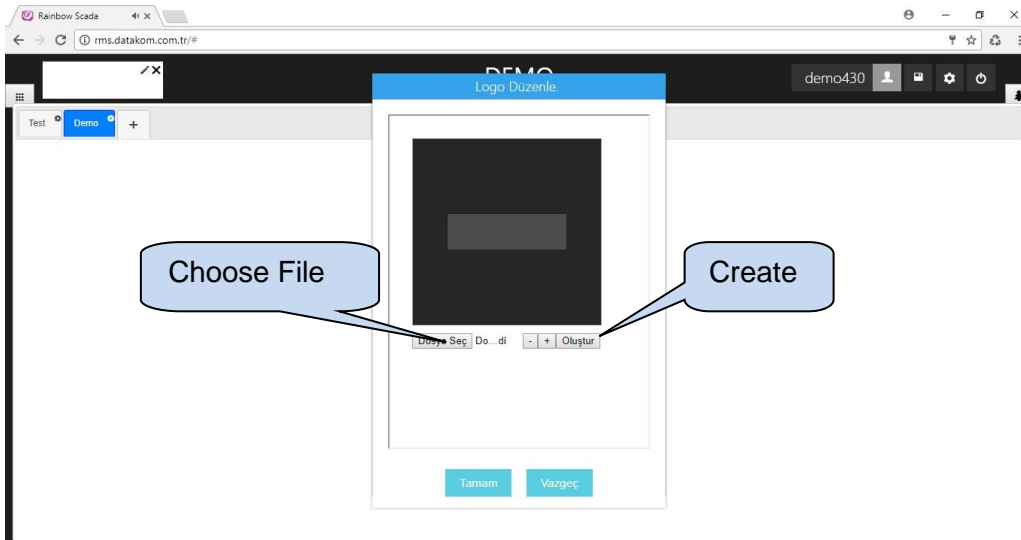

Click **Choose File** button to select logo image, which should be jpg or png format. Image that is selected will be placed on the screen to be adjusted. Image can be adjusted by drag and drop and zoomed in and out by **+** and **-** buttons. Click **Create** once logo is ready to use.

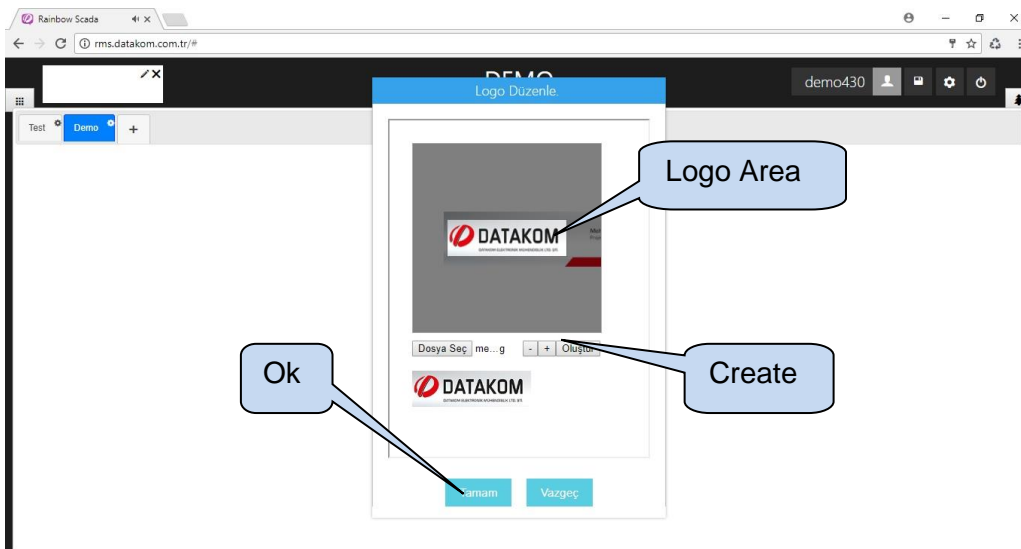

Click **Ok**, and logo will be set on the top left corner of the screen as shown on figure below;

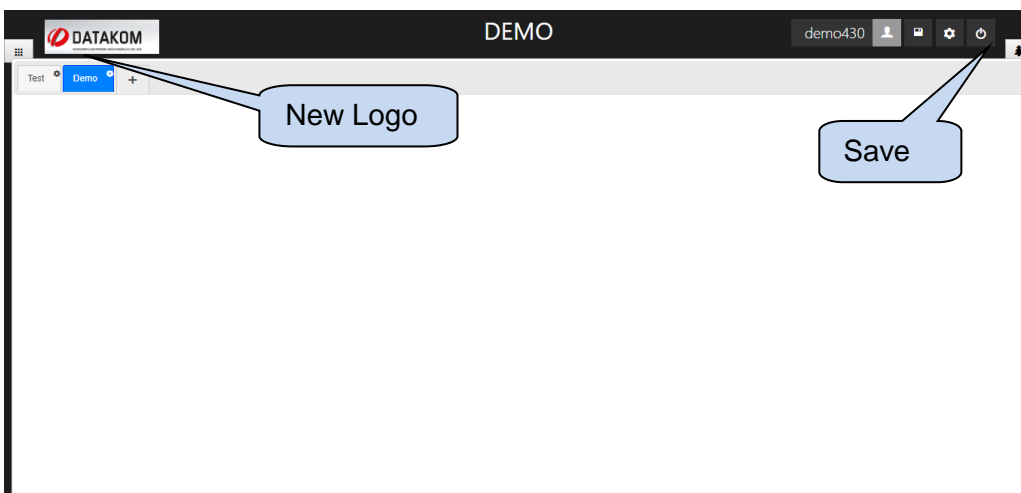

5.3.4 Create Header

The header of the remote monitoring screen will be automatically adjusted to the new entered text. In order to change the header, click on the current header, make necessary changes, and click button.

Any unsaved changes will be lost, click **save** button to save changes.

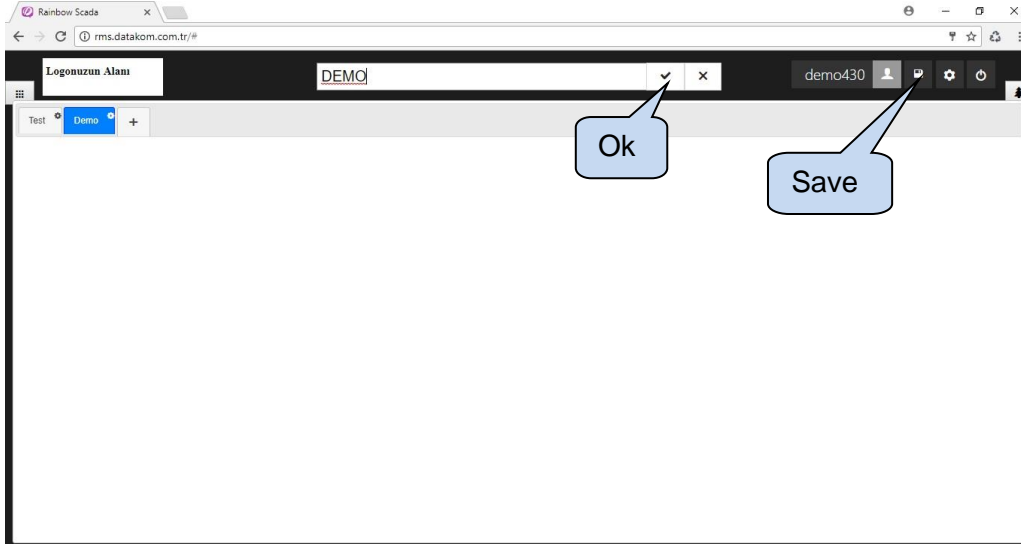

5.3.5 Change Background Colour

Click  button to change background colour.

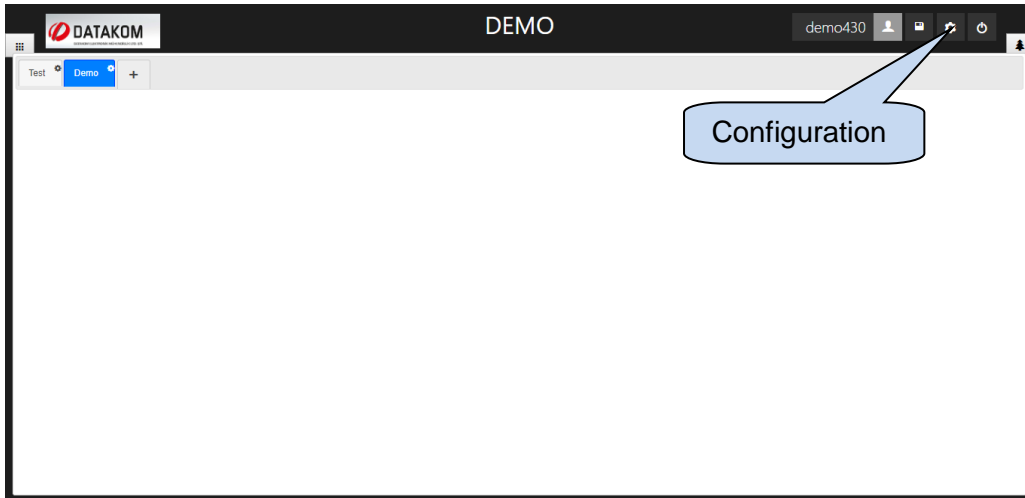

A new window will appear at the top of the screen. Select the required colour and click any location on the screen.

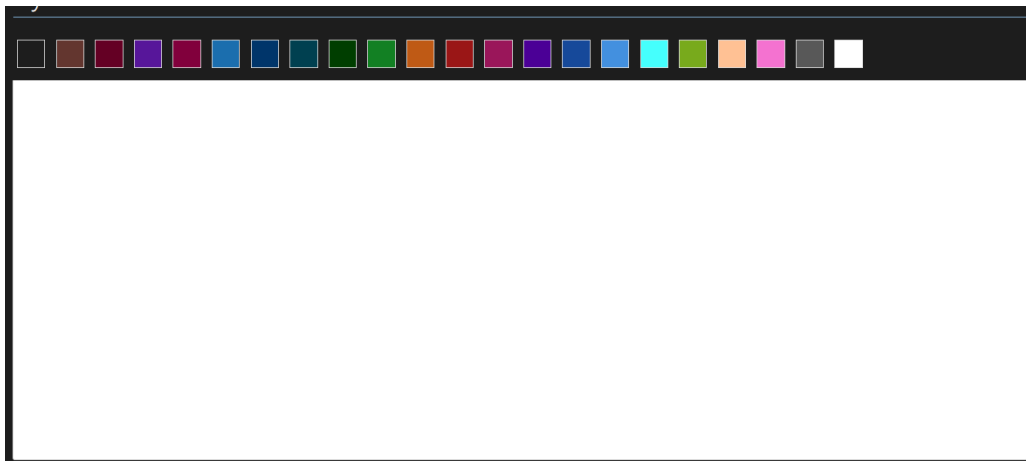

Background colour change will be applied immediately.

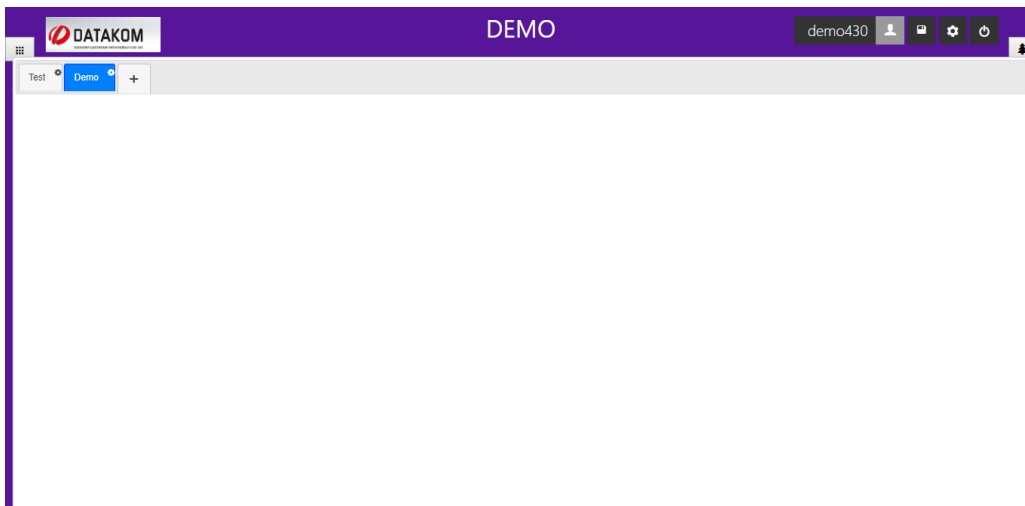

5.3.6 Add New Tab

Click  button to add a new tab to the remote monitoring screen.

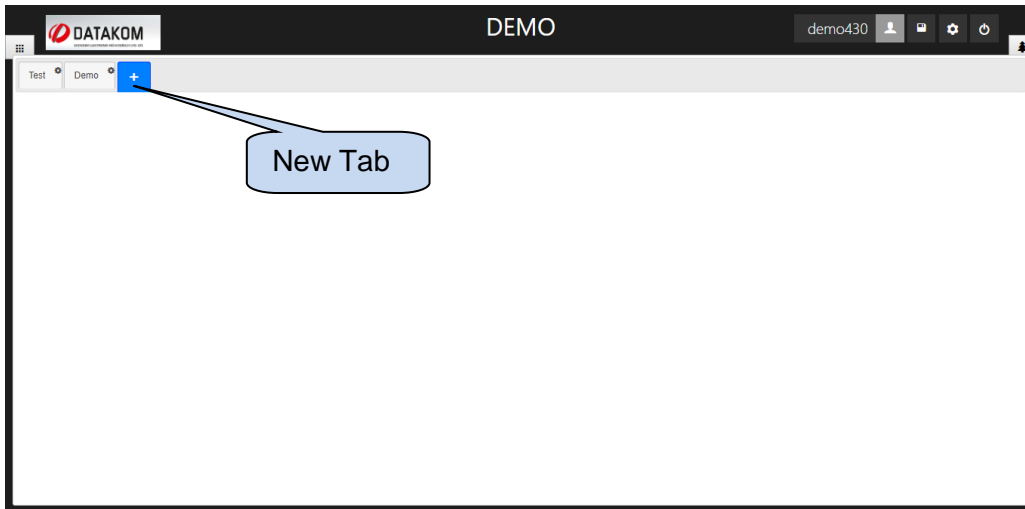

Type the name of the new tab on the new window appeared on the screen. After that, click **OK** button.

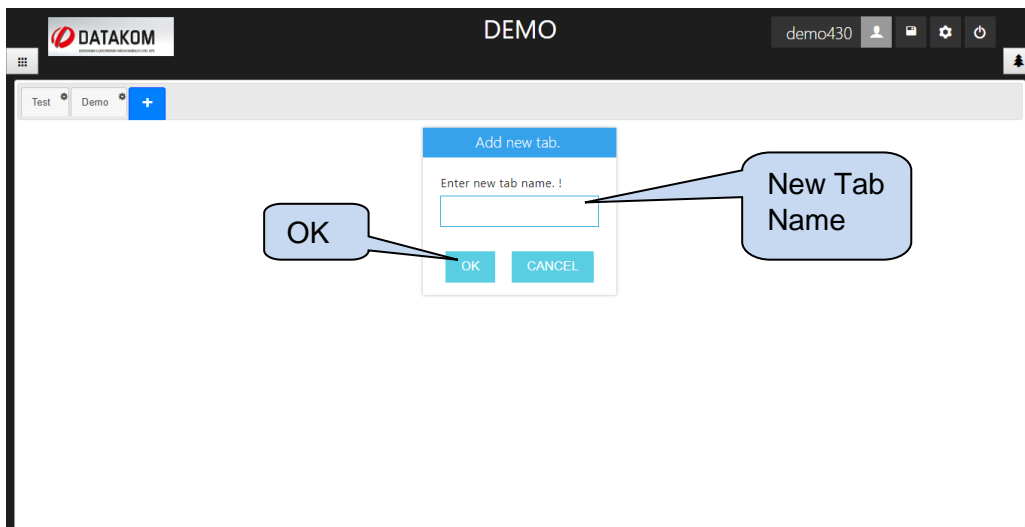

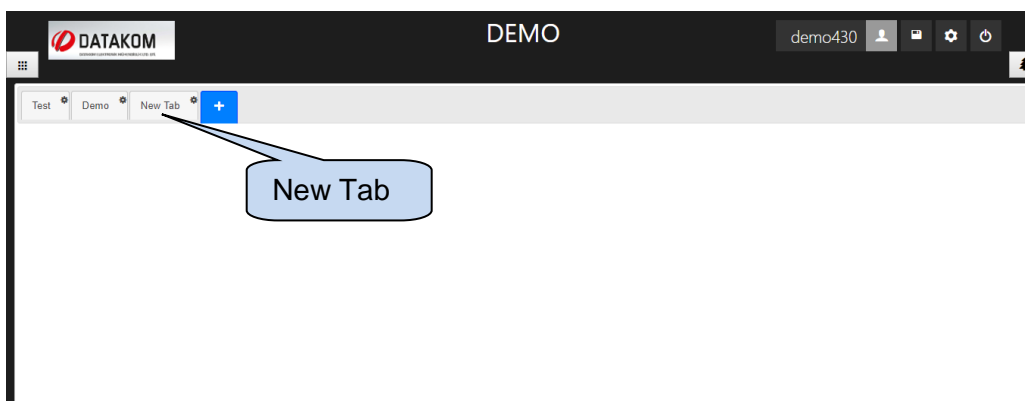

New tab will appear on the screen as shown below.

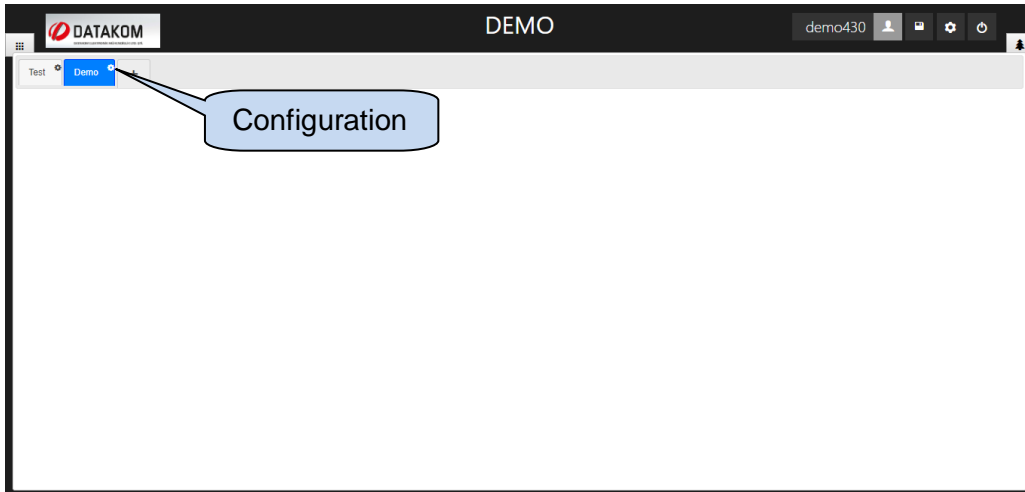

5.3.7 Rename Tab

Click  button to rename a tab.



New menu will appear under the tab. Click  button.

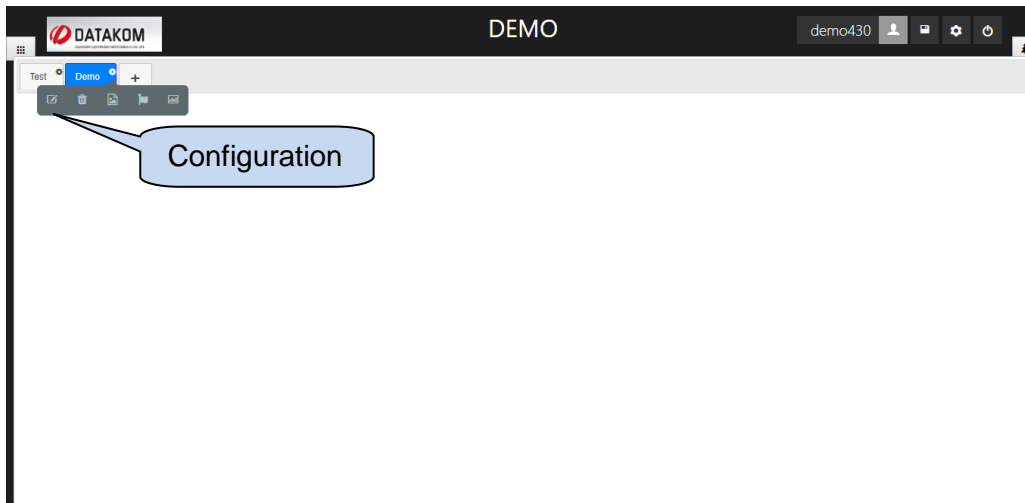

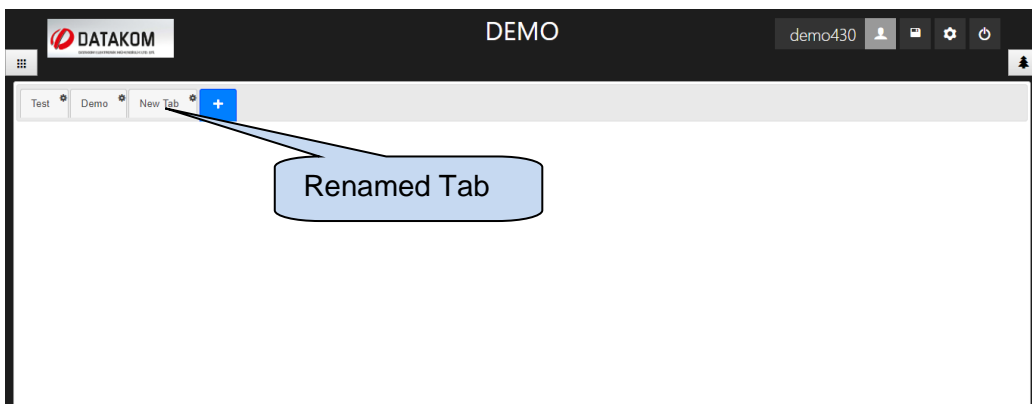
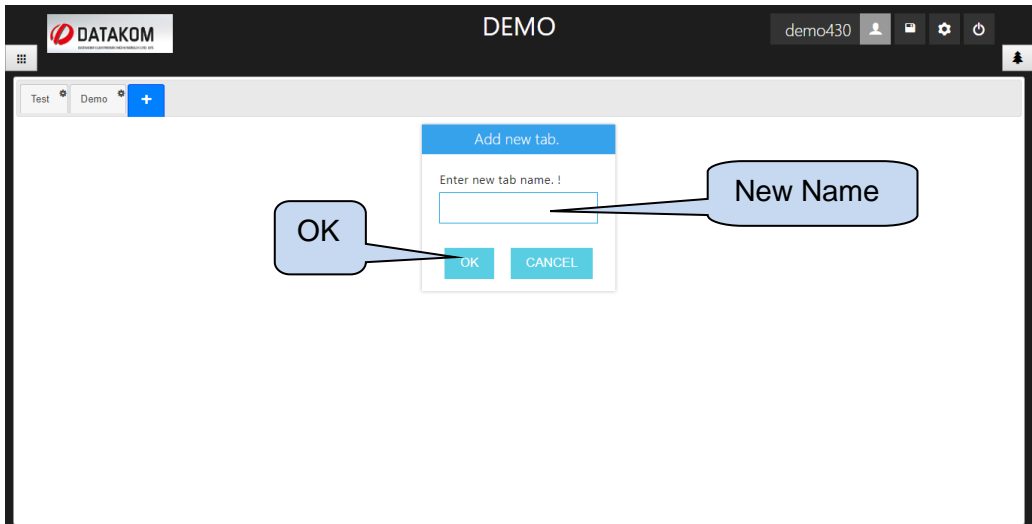

Type the name of the tab, and click **OK**.

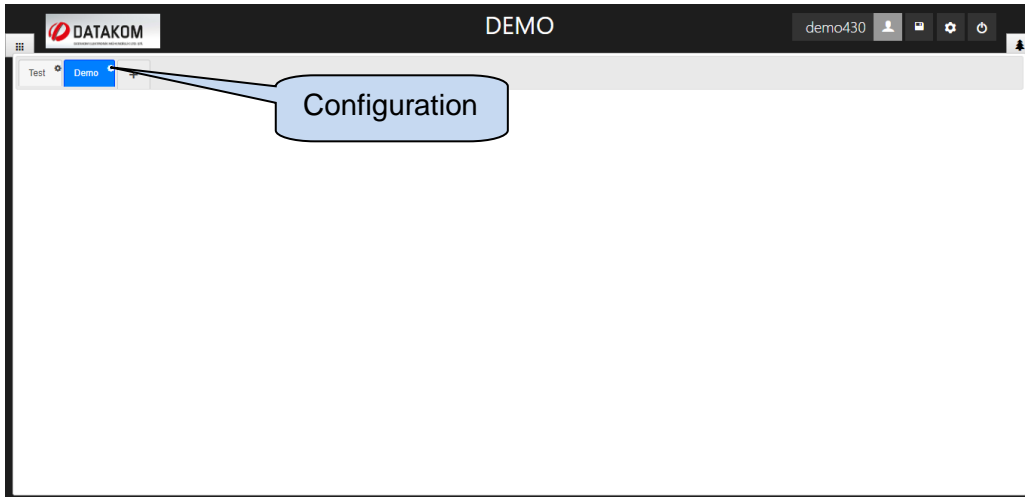

5.3.8 Remove Tab

Click  button to remove the tab.



New menu will appear under the tab. Click  button.

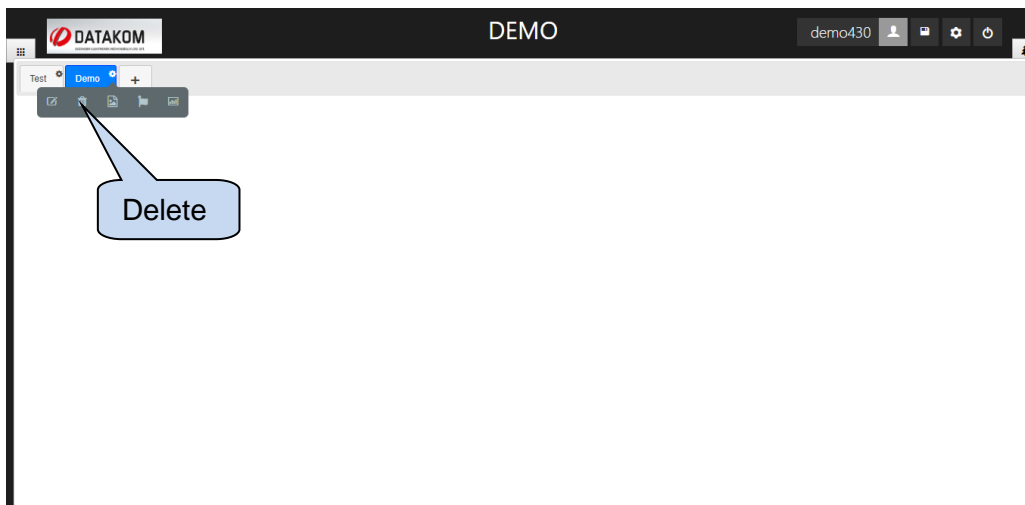

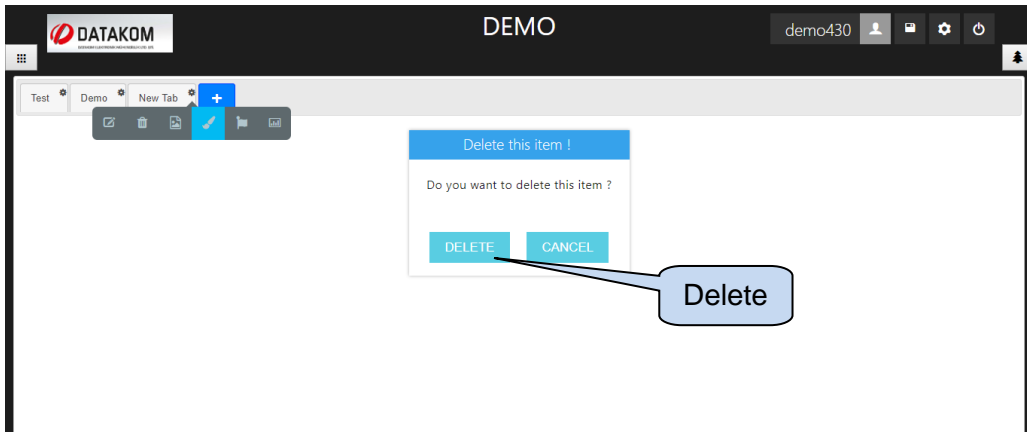

Click **delete** on the new window.

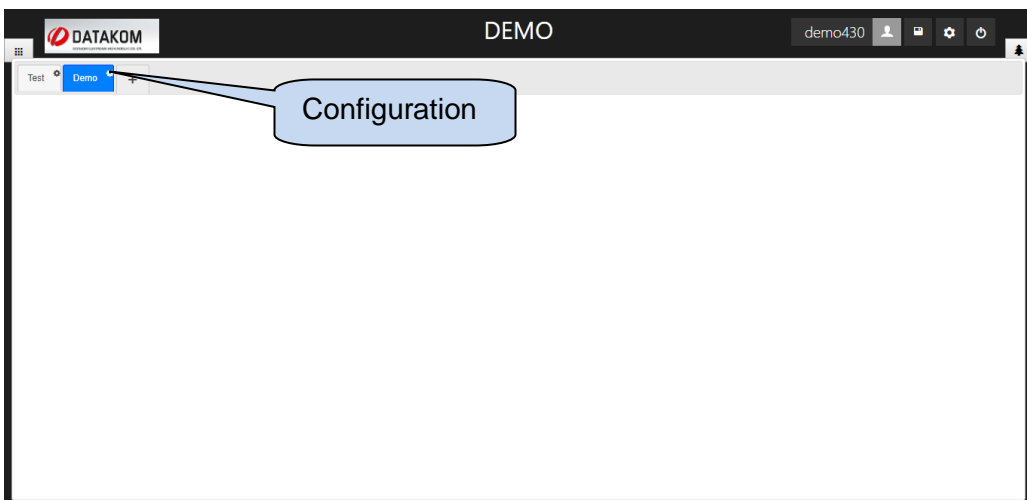

5.3.9 Add Background Image

Click  button to add background image to a tab.



New menu will appear under the tab. Click  button.

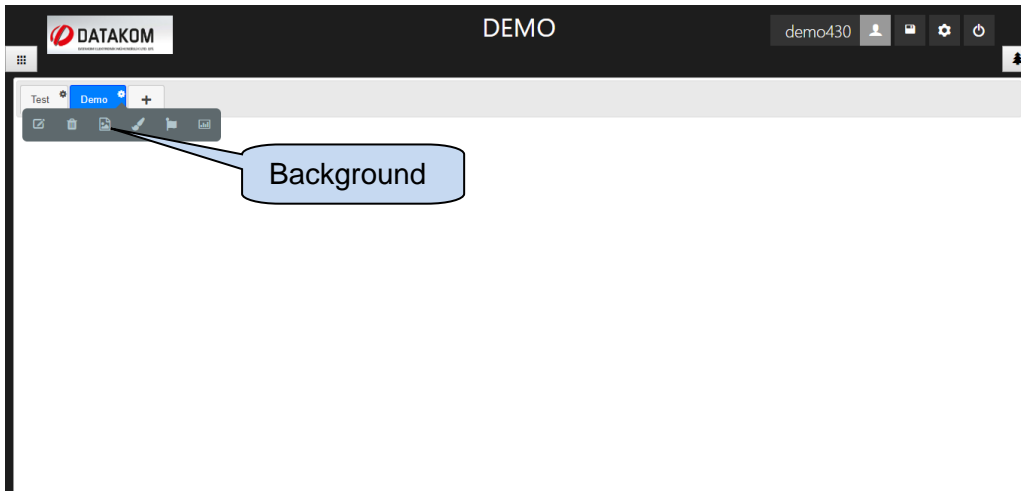

New window will appear allowing users to add background image. Click **Choose File** in order to add background image.

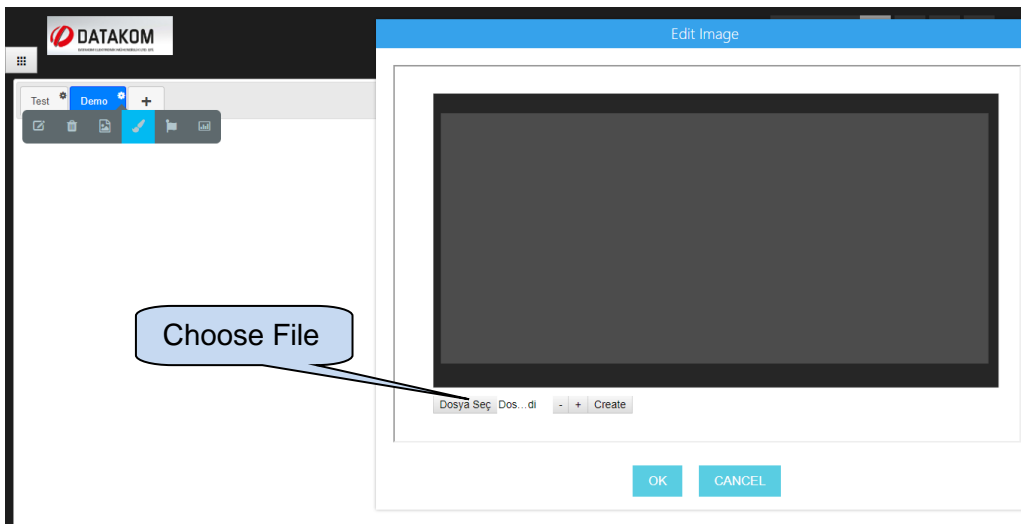

Choose a jpg or png file to be a background image, and click **open** button.

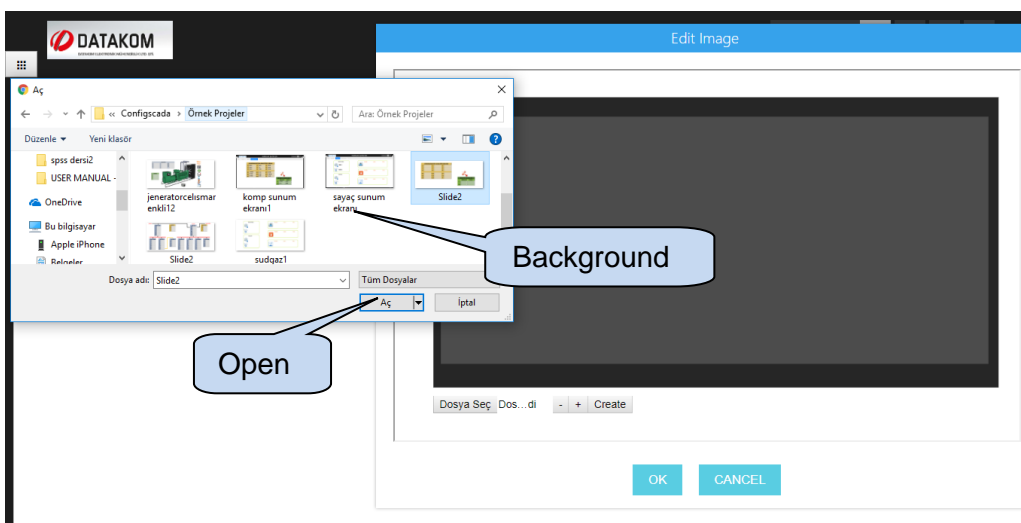

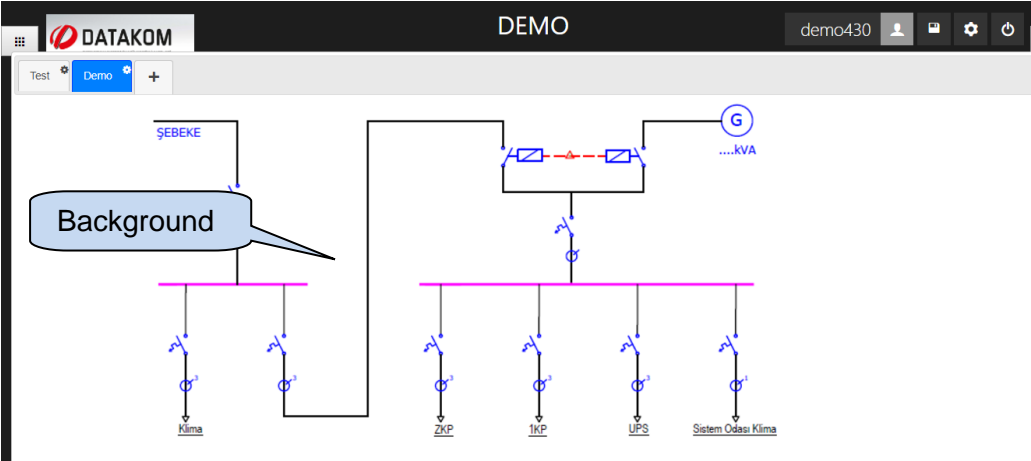
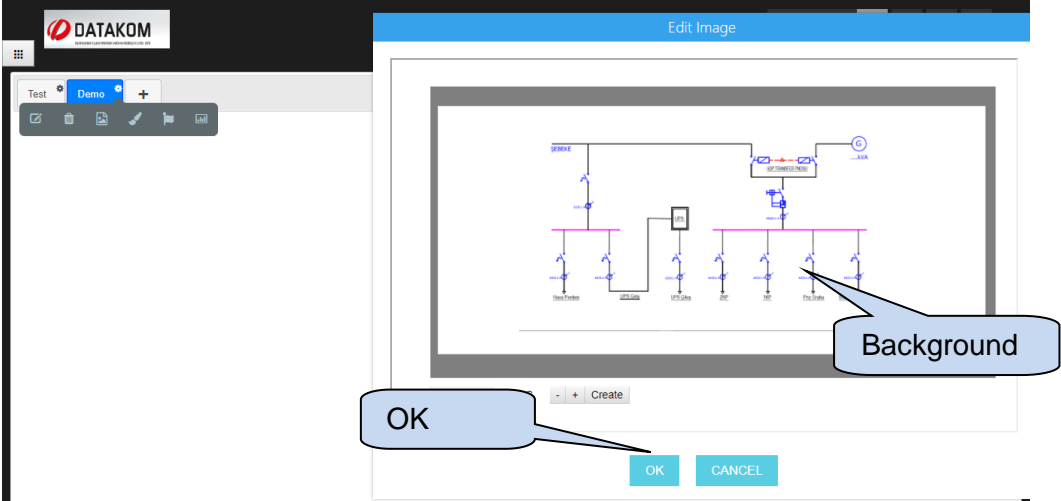

Click **Ok** button once the background image is selected.

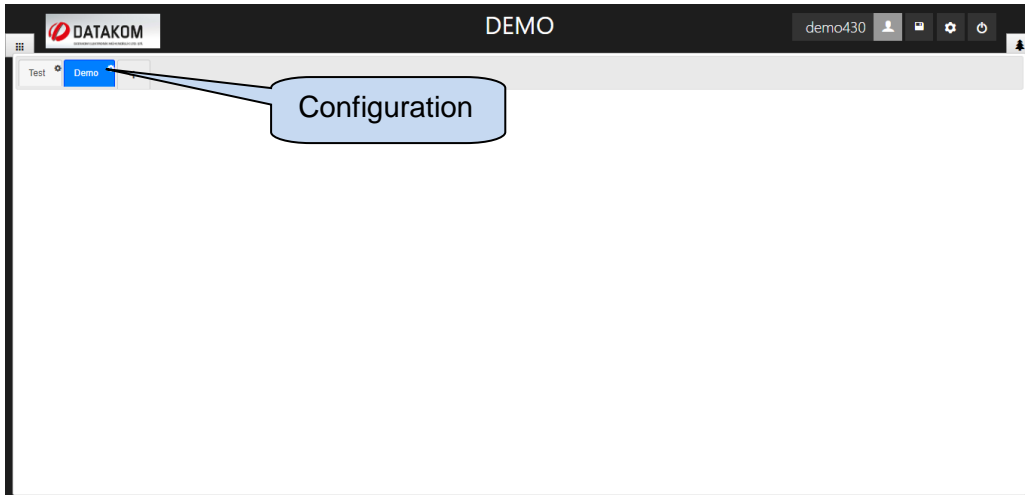

5.3.10 Add Icon

Click  button to add icon.



Click  button on the new menu displayed under the name of the tab.

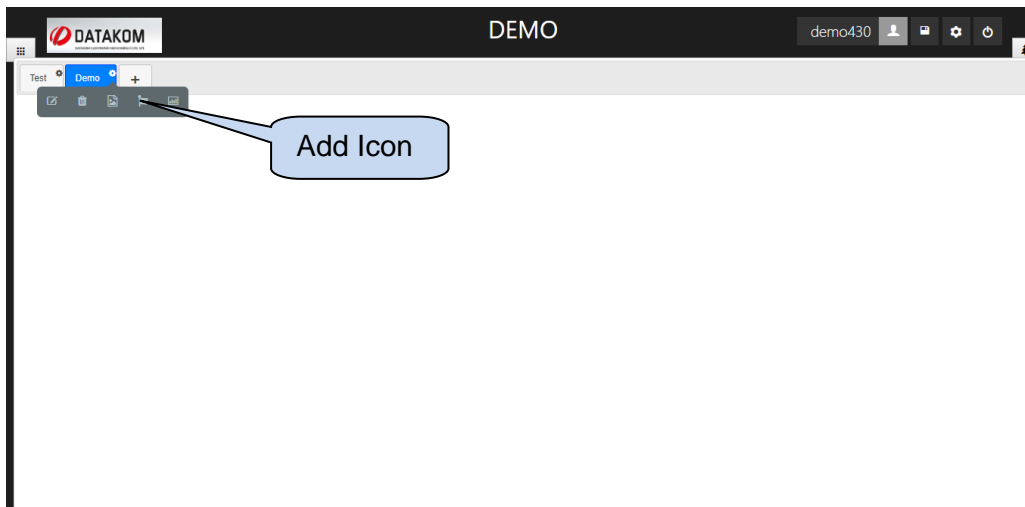

A new window will appear allowing users to add icons. Different icons can be selected by using filters, dimensions of those icons can also be changed by size tab. Select size, and click **list** to list available icons.

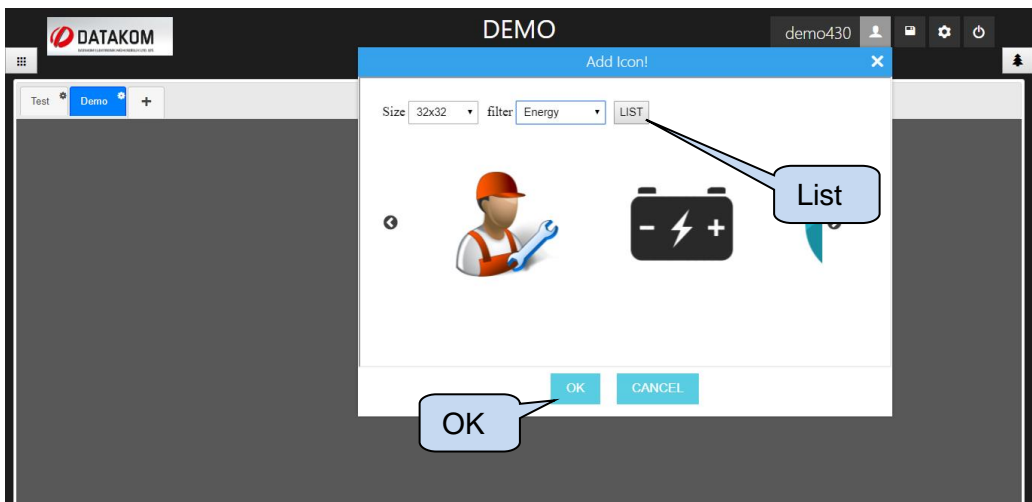
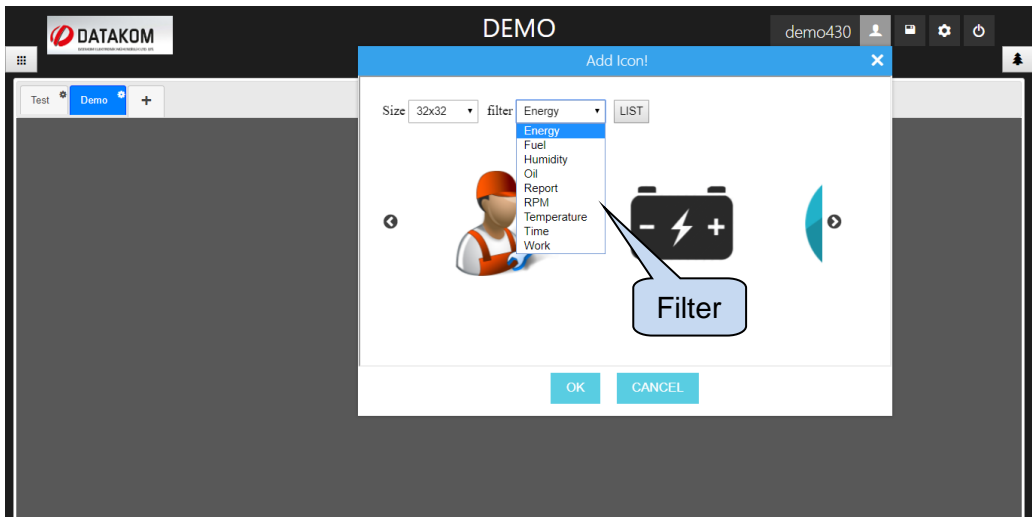
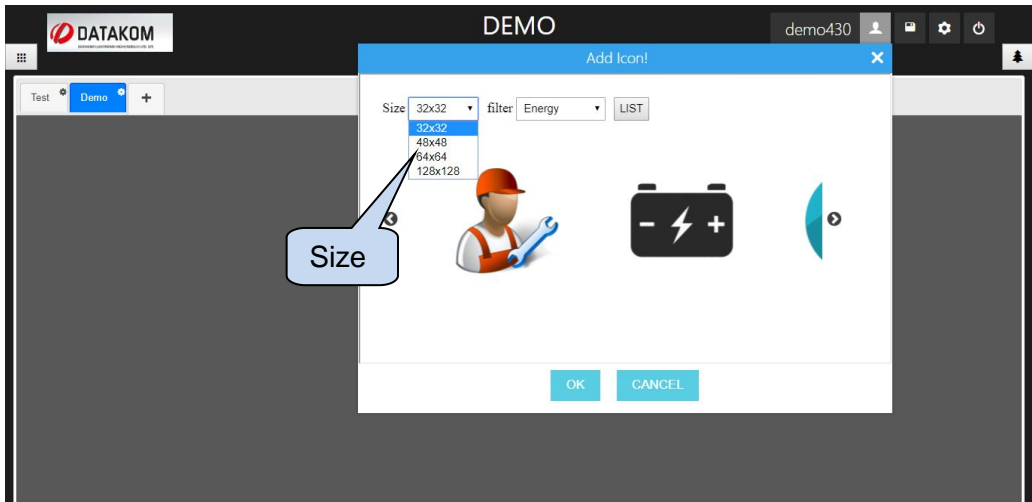

Once **OK** button is clicked, selected icon will be placed on the top left corner of the screen. You can drag-drop the icon to change position on the remote monitoring screen. Grids will help users to place the icon.

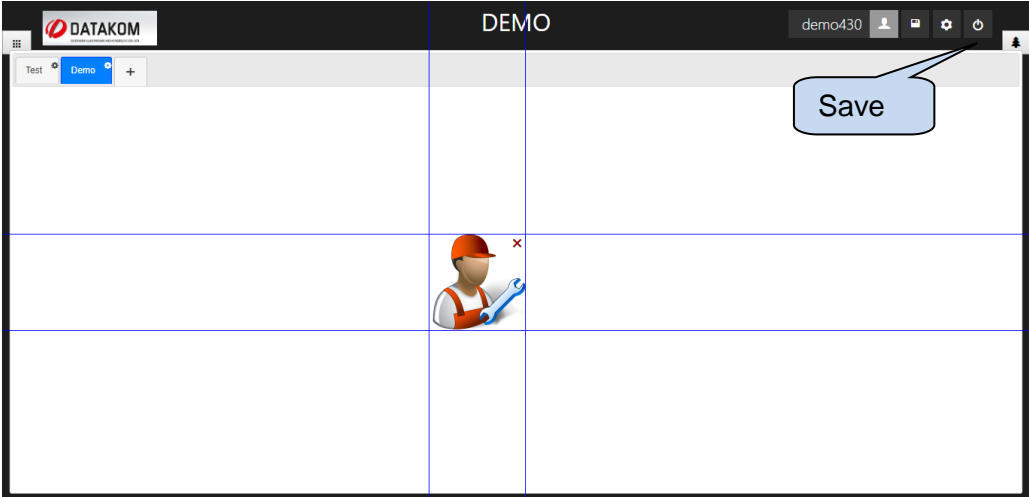
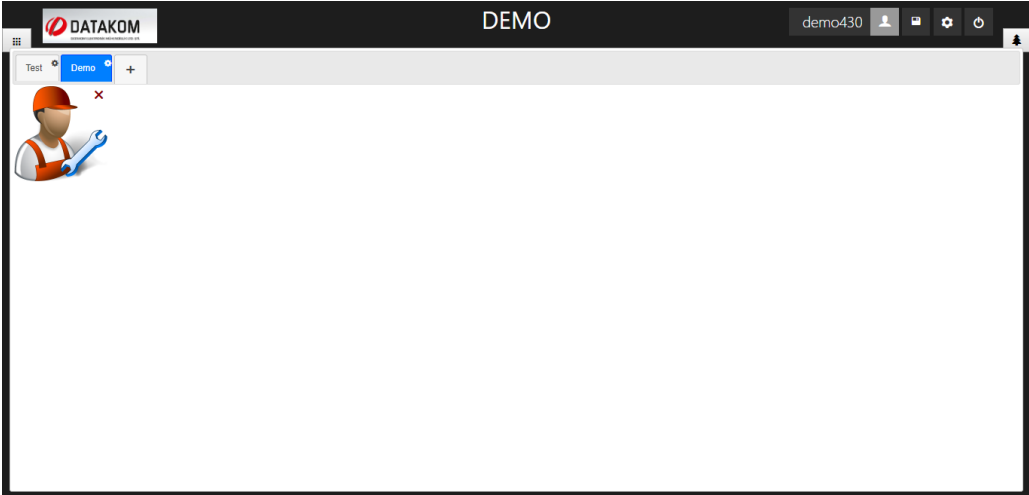

5.3.11 Measurement Values

5.3.11.1 Add Measurement Values

Any measured values belong to the devices on remote monitoring account can be displayed on any position on the remote monitoring screen. Colour, size and position of measured values can be configured by the user.

Click  button on the top right corner to add measurement value.

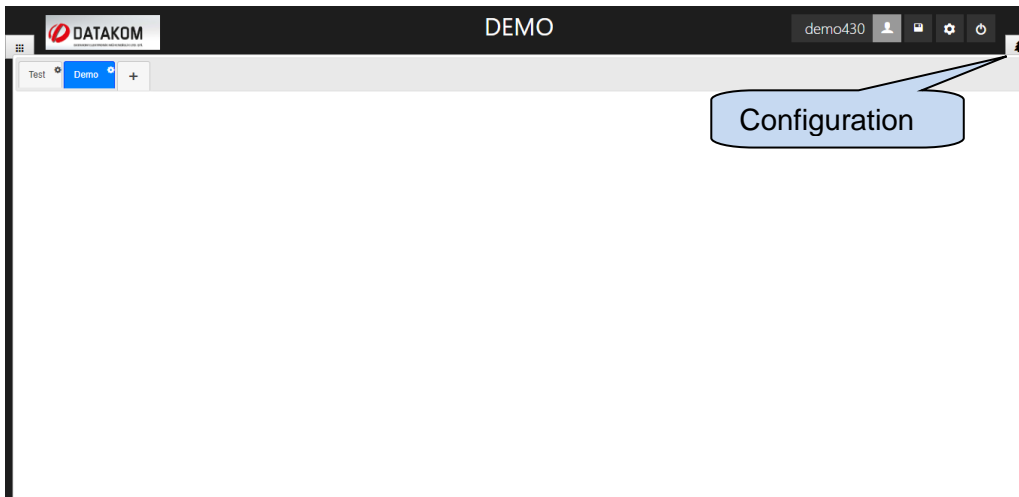

New tab will appear on the right hand side of the screen that has remote monitoring devices and objects.

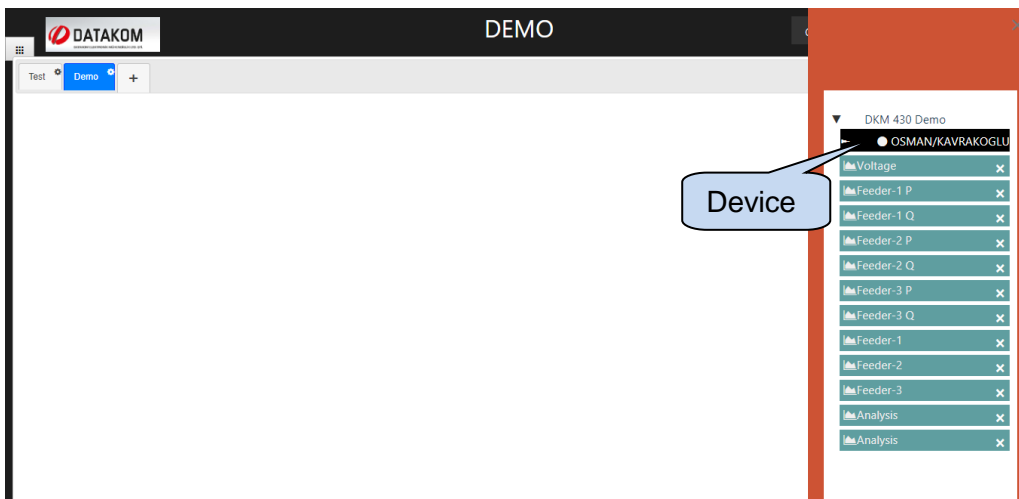

Click on one of the devices to display the list of available measurement values on the screen. Measurement values list will change automatically depending on the device.

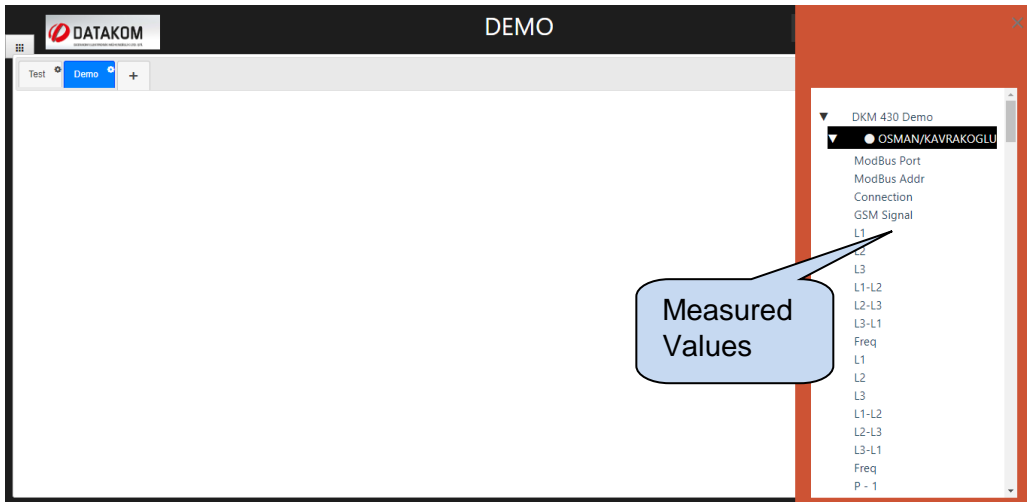

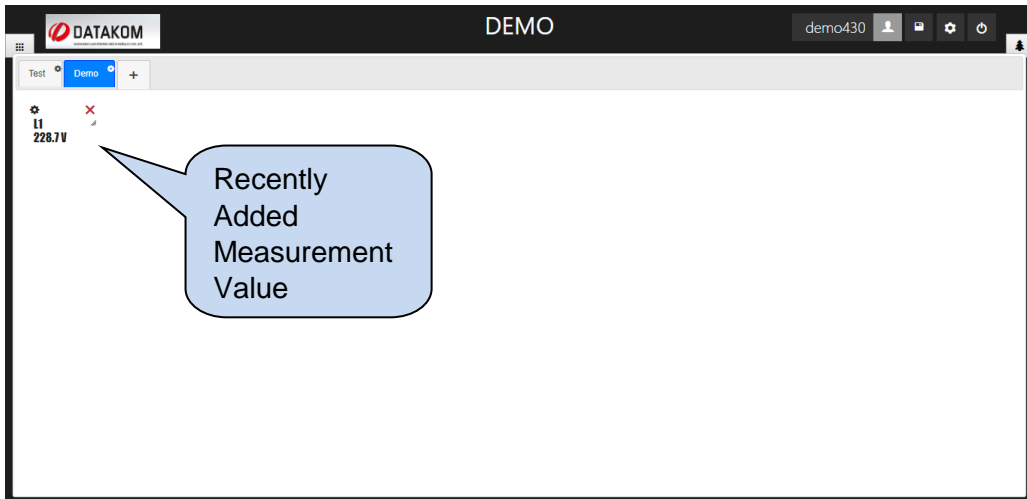

You can drag and drop parameters from the list on the right hand side to the remote monitoring screen. It is also possible to change the position of the measurement values by drag and drop.

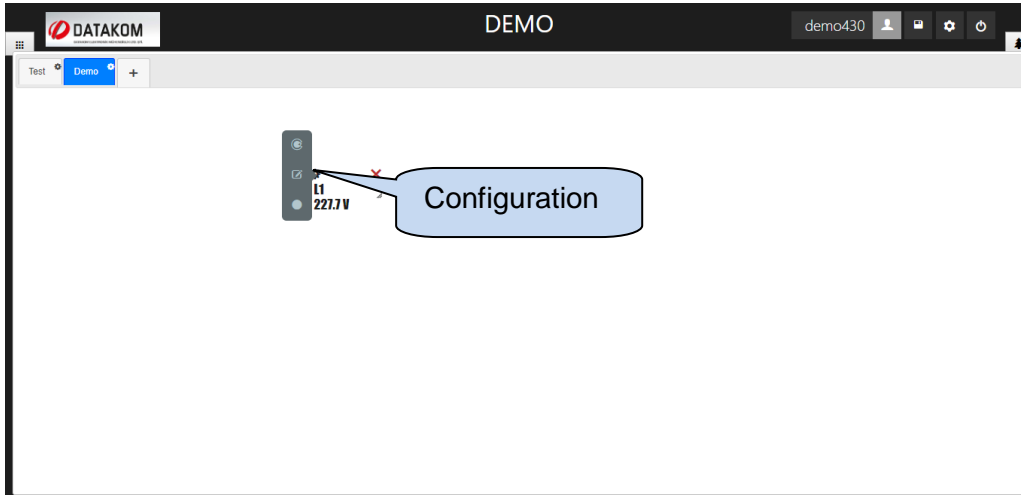

5.3.11.2 Create Gauge

Click  button to create a gauge, which is related with a measurement value. New menu will be displayed next to the measurement value as shown below;



In order to create a gauge related to a measured parameter, click  button and choose a gauge on new window.

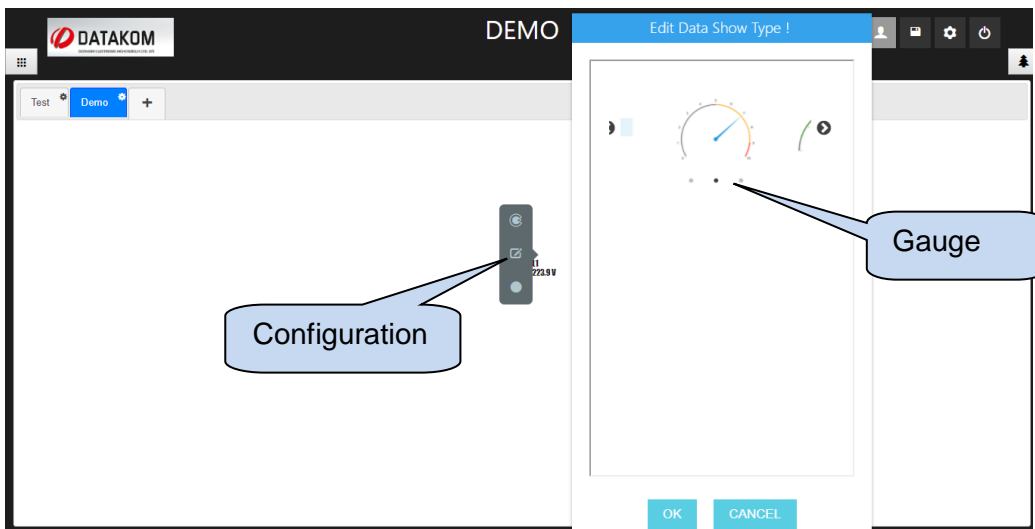

Once the gauge is selected, parameters related with gauge will be listed as shown below;

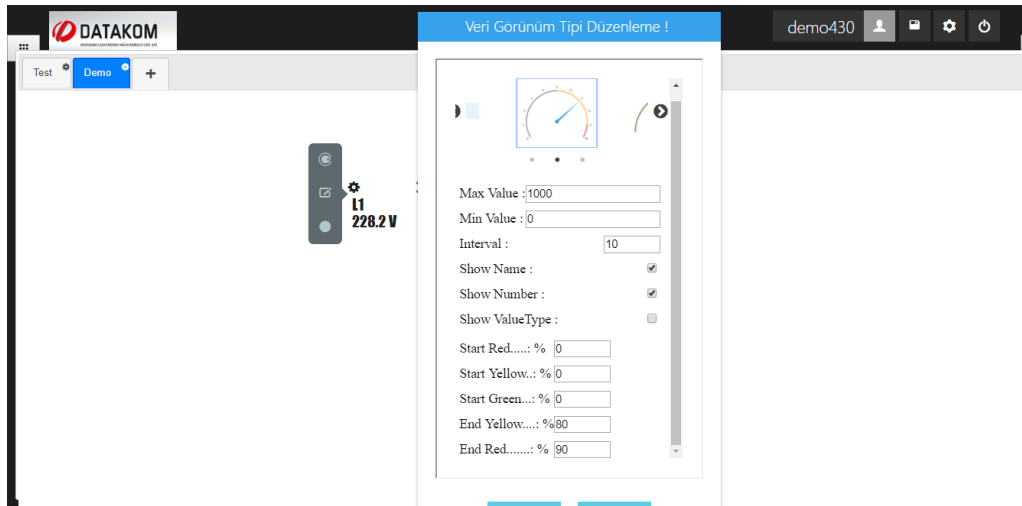

Max Value: Maximum value of the gauge.

Min Value: Minimum value of the gauge.

Interval: Increment between two consecutive values on the gauge.

Show Name: Displays name of the measured value.

Show Number: Display numbers.

Show Value Type: Display type of the measured value.

Start Red: Starting value of the red indicator.

Start Yellow: Starting value of the yellow indicator.

Start Green: Starting value of the green indicator.

End Yellow: Ending value of the yellow indicator.

End Red: Ending value of the red indicator.

Click **Ok**, and created gauge will be displayed on remote monitoring screen. Click **save** button to save changes.

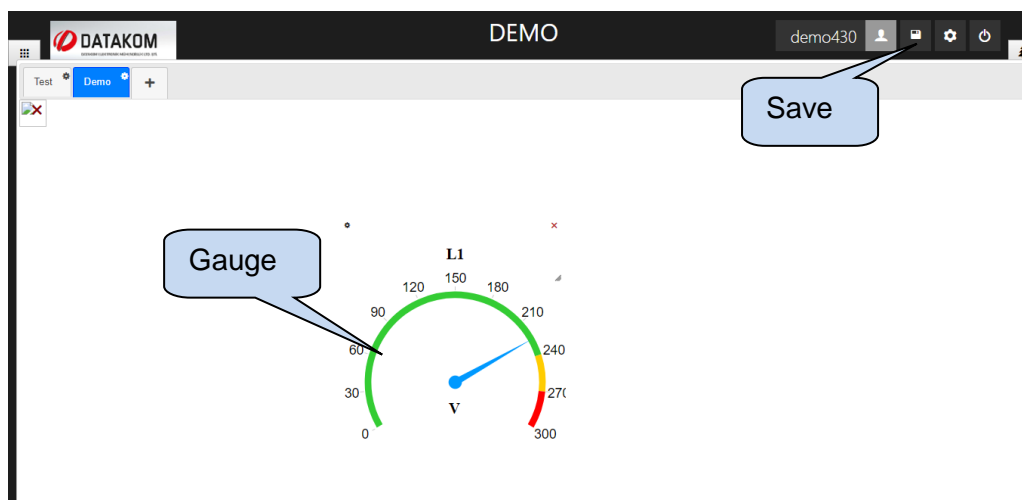

5.3.11.3 Display Settings of Measurement Values

Click  button to edit display of the measurement value. New tab will appear next to the measurement value as shown below;

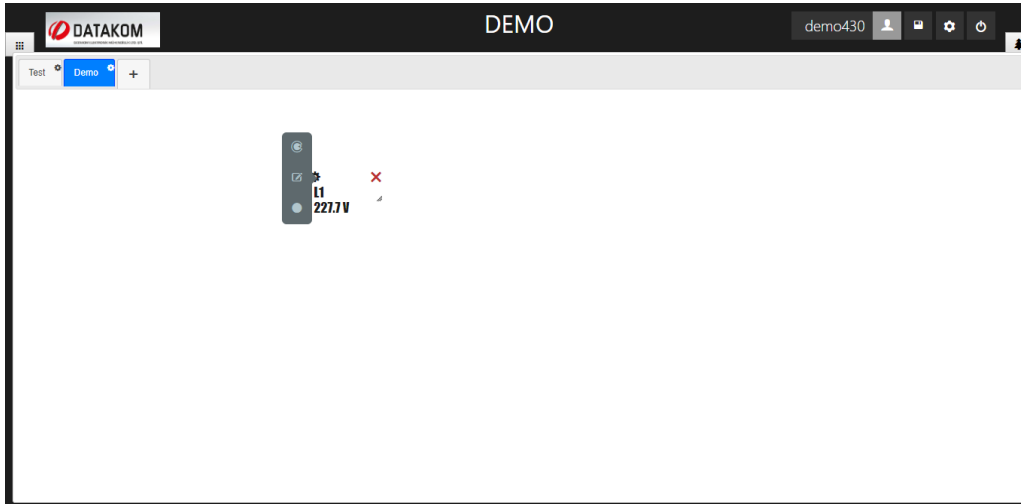

Click  button to change display settings. New window will appear, and editable parameters will be displayed as shown below;

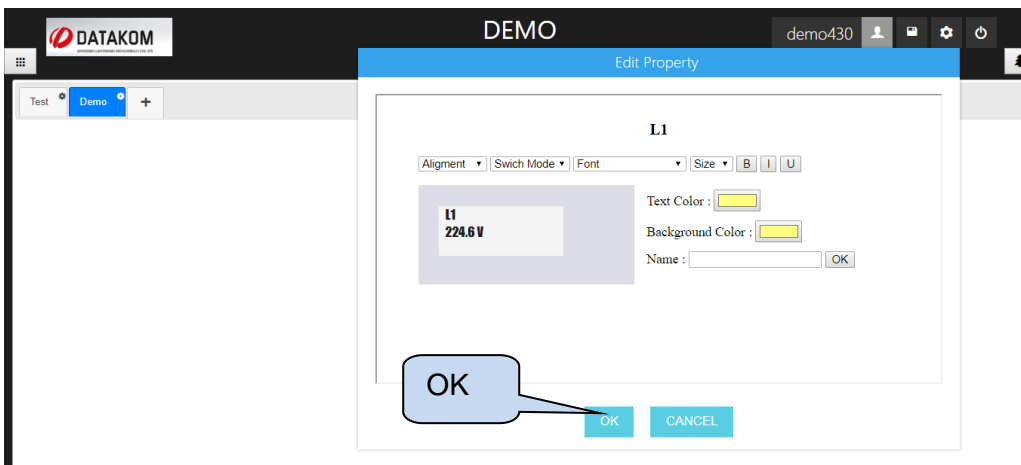

Alignment: Measurement value can be positioned vertically or horizontally.

Switch Mode: Digital outputs can be selected normally open or normally closed.

Font: Font of the measurement value.

Size: Size of the measurement value.

Text Colour: Colour of the measurement value.

Background Colour: Background colour can be adjusted.

Name: Name of the measurement value.

Click **OK** after necessary changes has been done. Changes will be applied immediately. Click **save** to save changes.

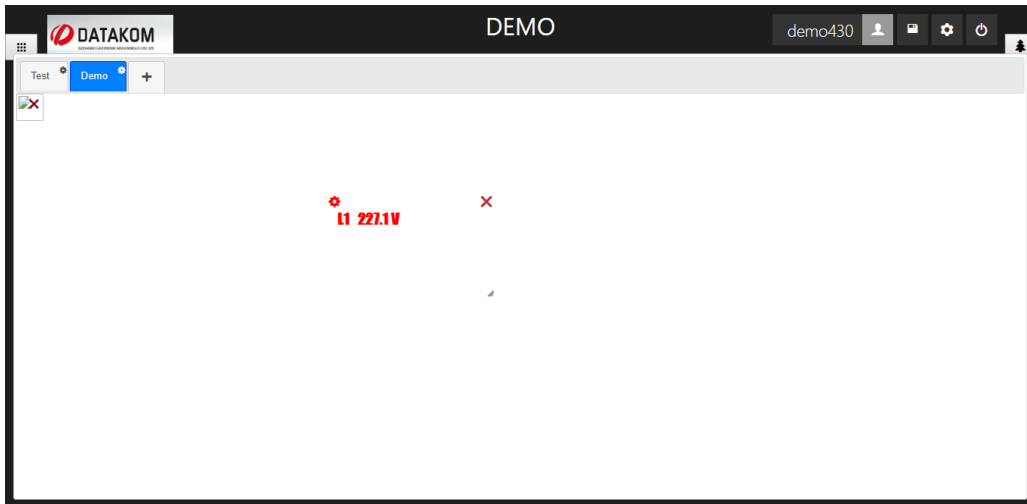

State of the background colour can be active/passive by  button.

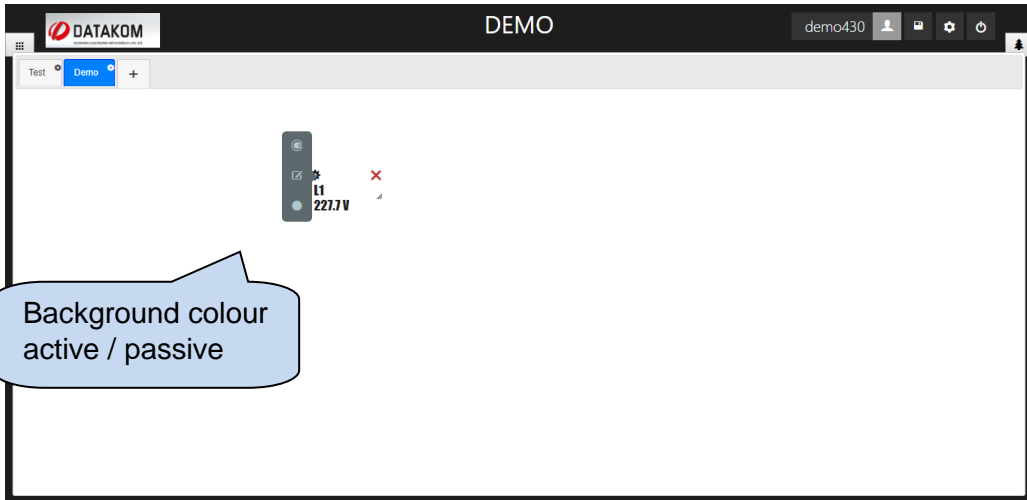

5.3.12 Add Object

Objects can be defined as structures that allow users to display measured parameters uniquely on remote monitoring screen. There are many object types to provide flexibility to the user. Those are;

- Energy Interruption
- Daily kW
- Arithmetic
- Consumption
- Multiple Value Chart
- Table

User can design a remote monitoring screen by using combination of the objects.

Click  button to add object in configuration mode.

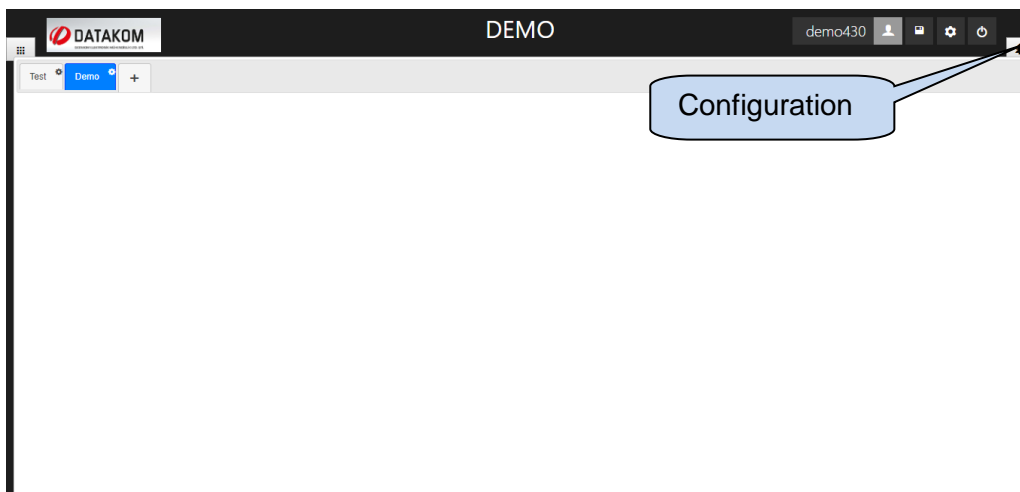

A new window will appear at the right hand side of the screen. You can see objects, which are created before and ready to use. Right click on the new window and select add object.

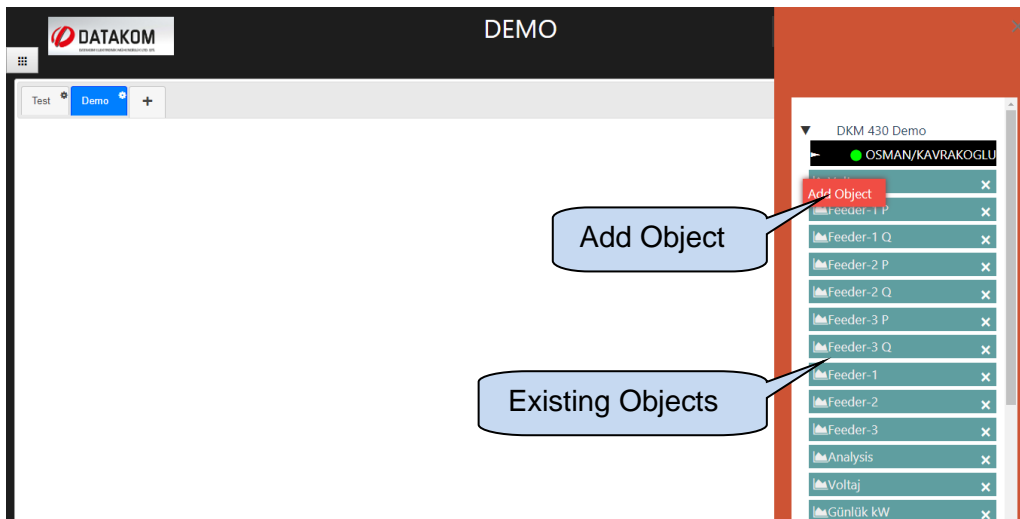

A new window will appear to create objects. Specify object name and object type and click **next**.

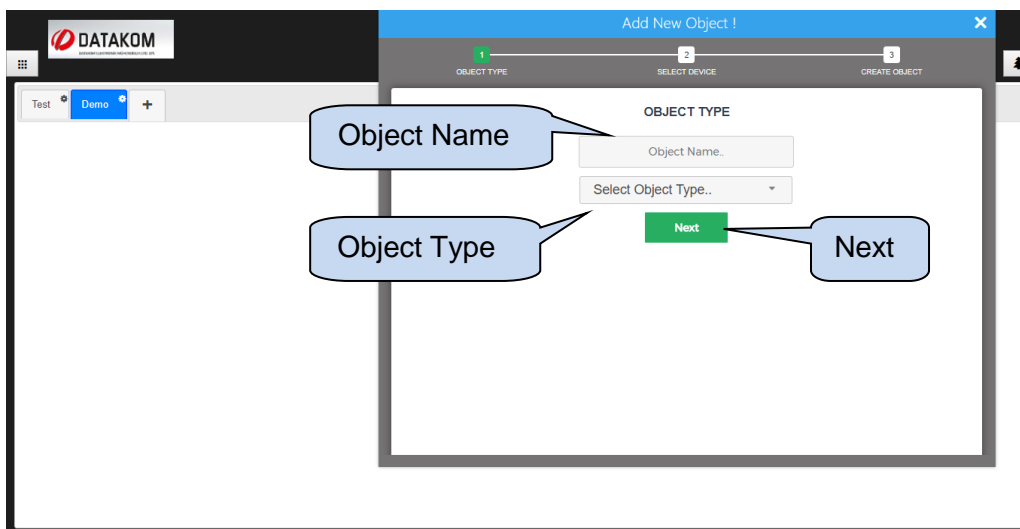

Next step is to choose measurement values to form an object. Since measurement values are different for each device, available measurement values to form an object will be different for each device. Choose the device and click **search** button. Available measurement values will be listed at the left hand side of the window.

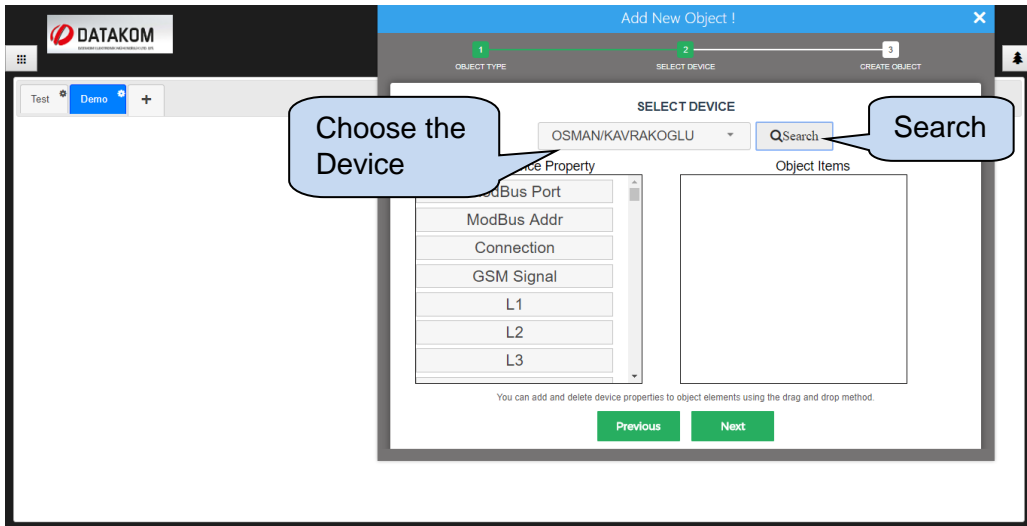

Drag required values listed on the “Device Property” column to the object items one by one, and click **next** for next step.

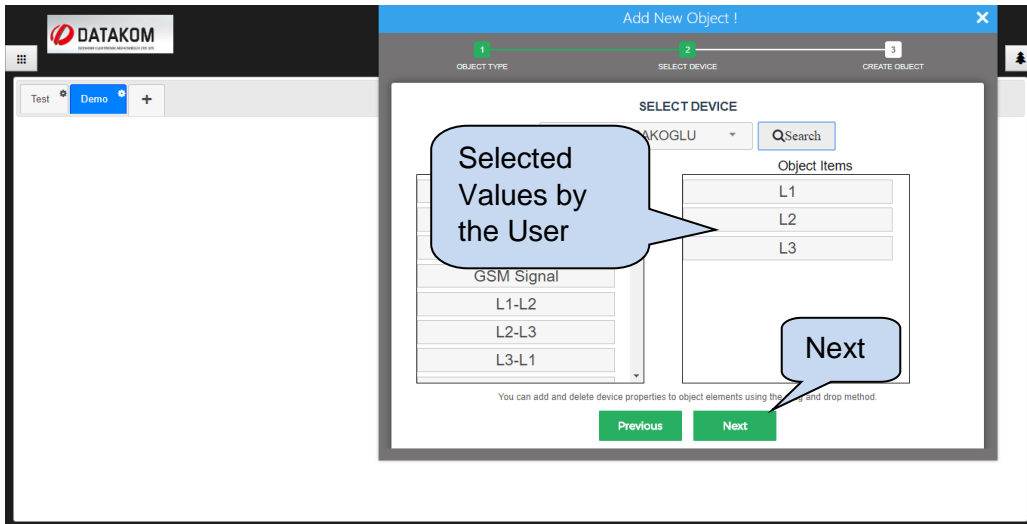

Some object types require start date and end date. (Detailed information will be provided on the Object Types section) If the object requires a time interval, adjust start and end dates and click **create object**. Item added successfully notification will be displayed at the top right corner of the screen.

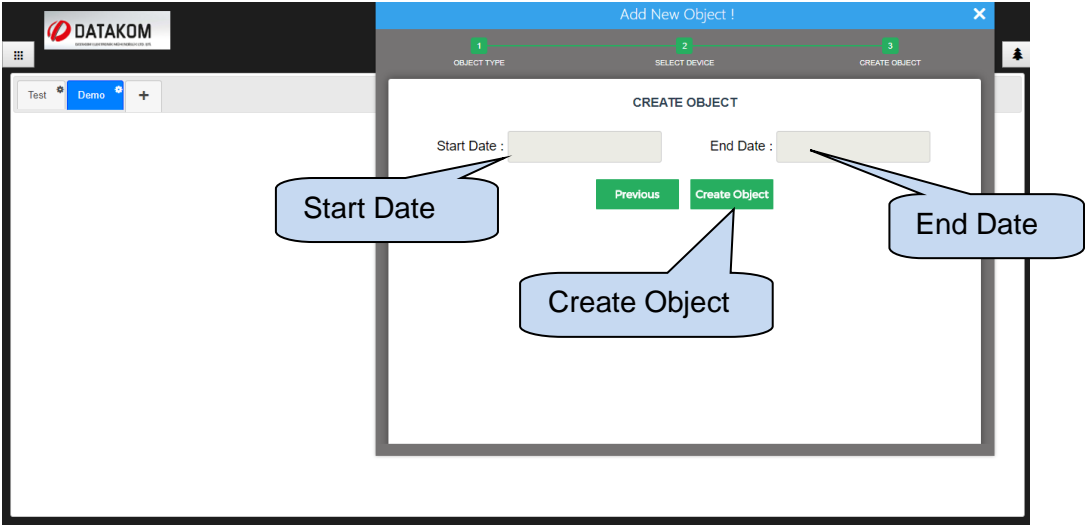

You can view all objects by clicking  button.

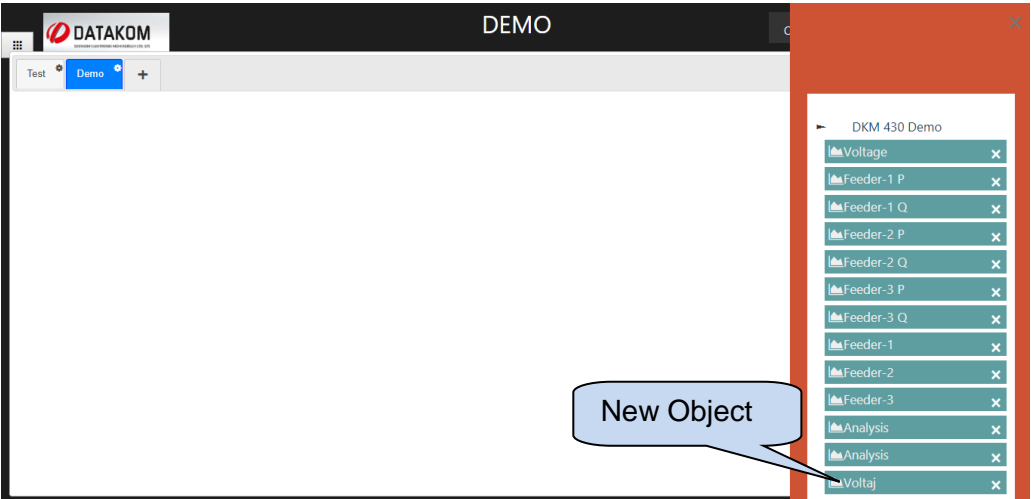

5.3.13 Object Handling

You can view all objects on the right hand side of the screen by clicking  button.

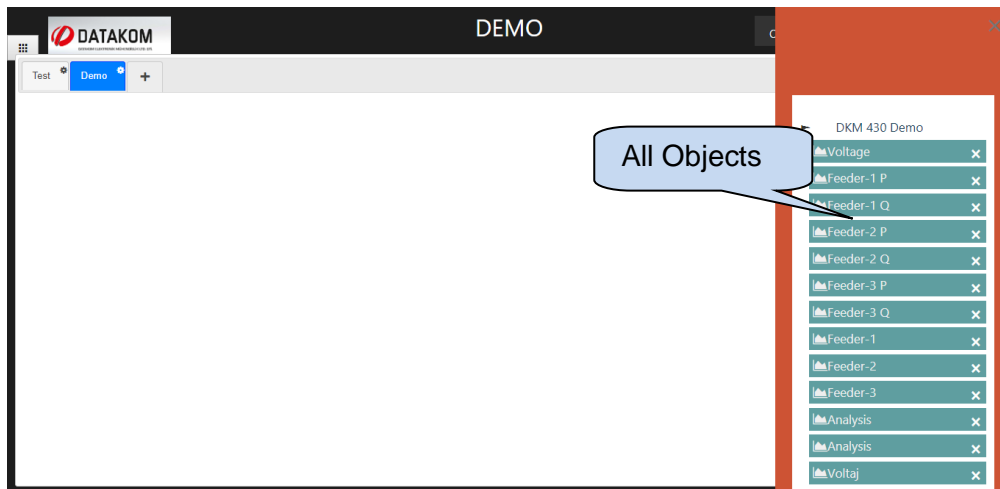

At first, objects will be placed at the top left corner of the remote monitoring screen. You can drag and drop them to the specific position on the screen.

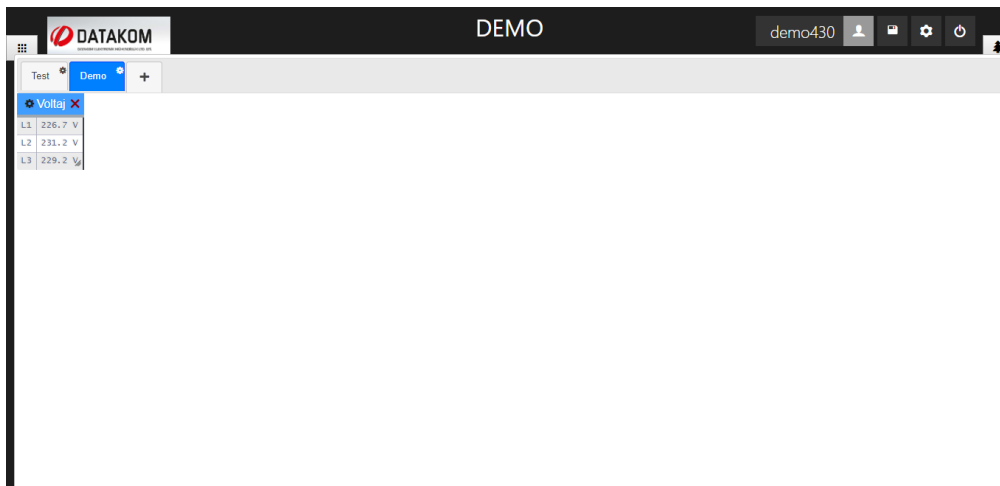

Once the object is placed on the screen, values will be updated automatically.

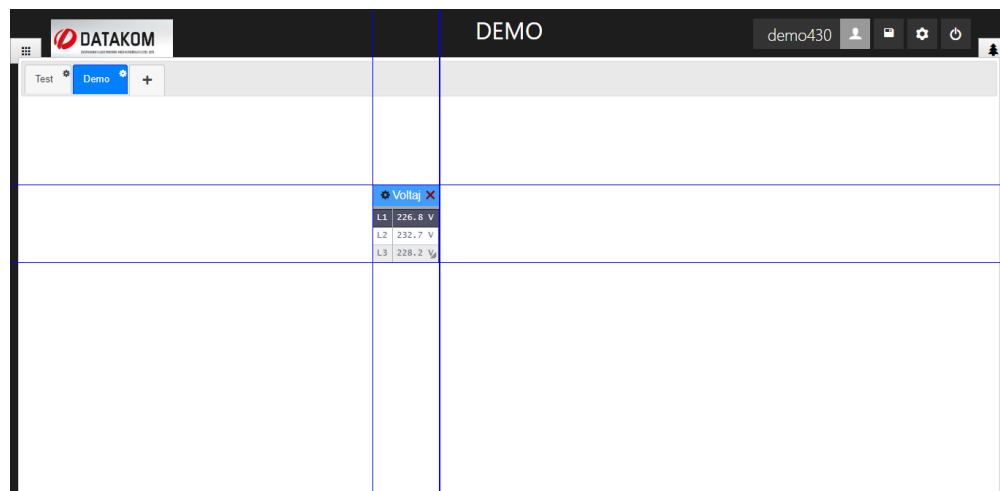

5.3.14 Remove Object

Click  button on the right hand side to remove an object. Click **ok** on the warning message.

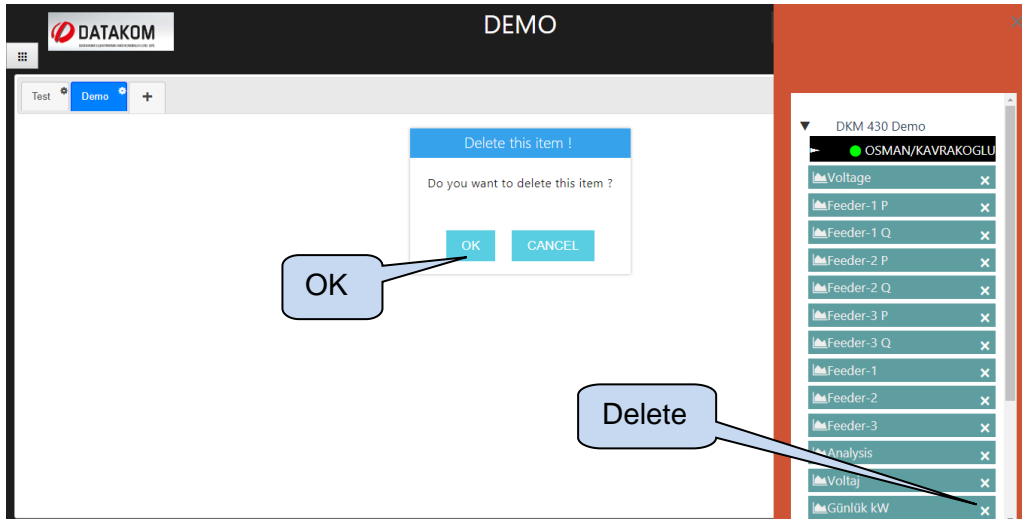

5.3.15 Object Types

5.3.15.1 Energy Interruption Object

Energy interruption object performs comparison between a user configurable limit and a measurement value. Comparison methods include “greater”, “less”, “equal”, and “not equal” operations.

Once device is specified and object type is selected as energy interruption, values must be placed from device property column to the object items column one by one. During this process, comparison conditions must be also configured.

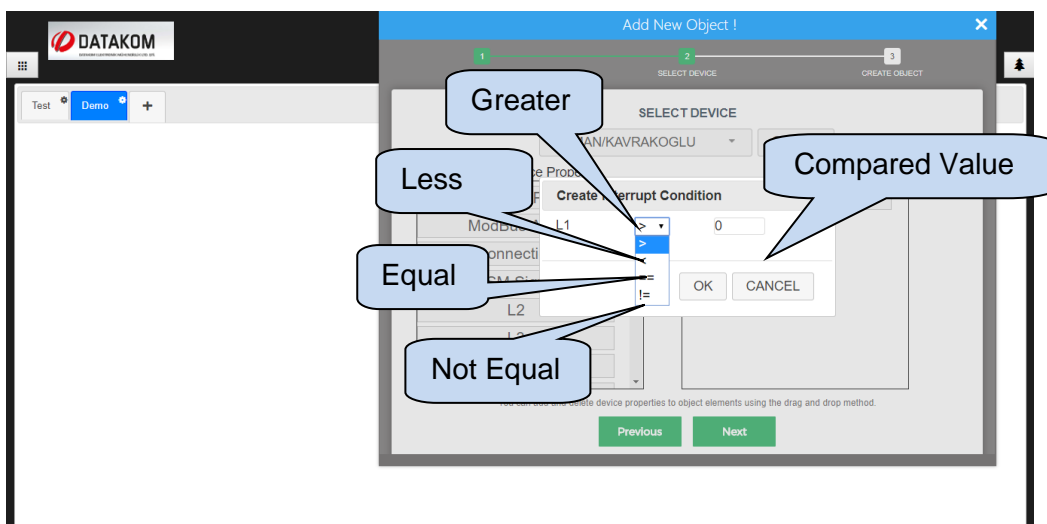

User will get a notification once condition between measured value and compared value is met. Moreover, multiple measurement values can be compared in the same object; and those comparisons can be combined with “AND” or “OR” logical operations.

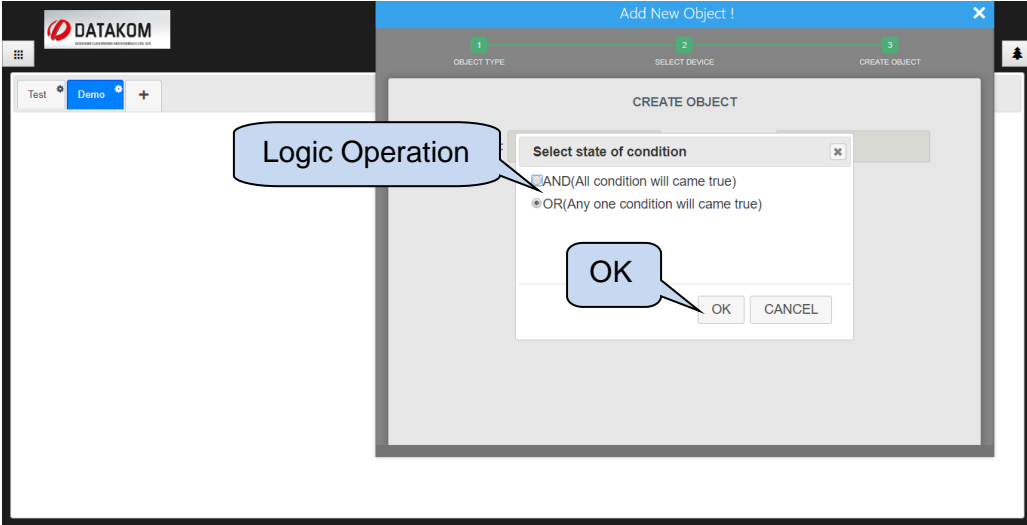

You can view all objects on the right hand side of the screen.

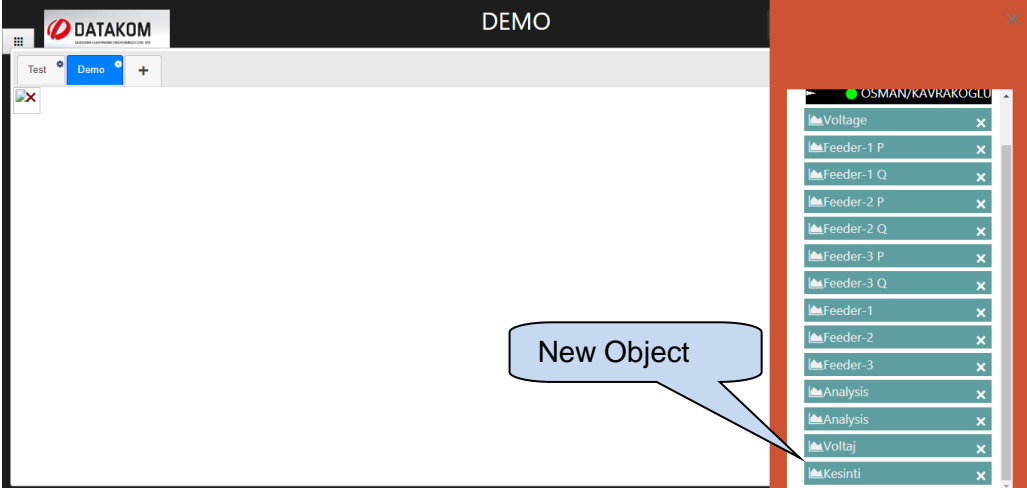

5.3.15.2 Daily kW

Daily kW object provides a graph of electricity consumption for specified dates. Once device is specified and object type is selected as daily kWh, values must be placed from device property column to the object items column one by one.

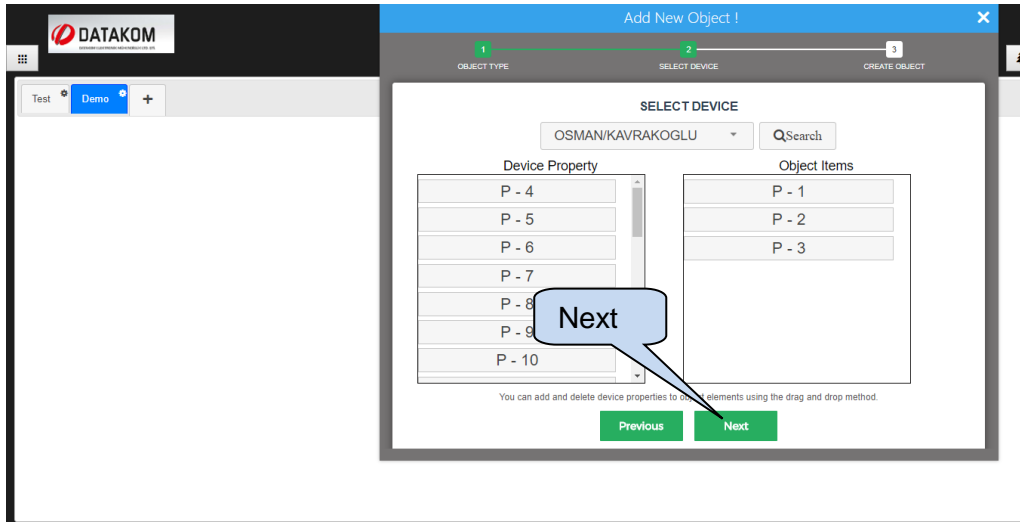

Click create object button.

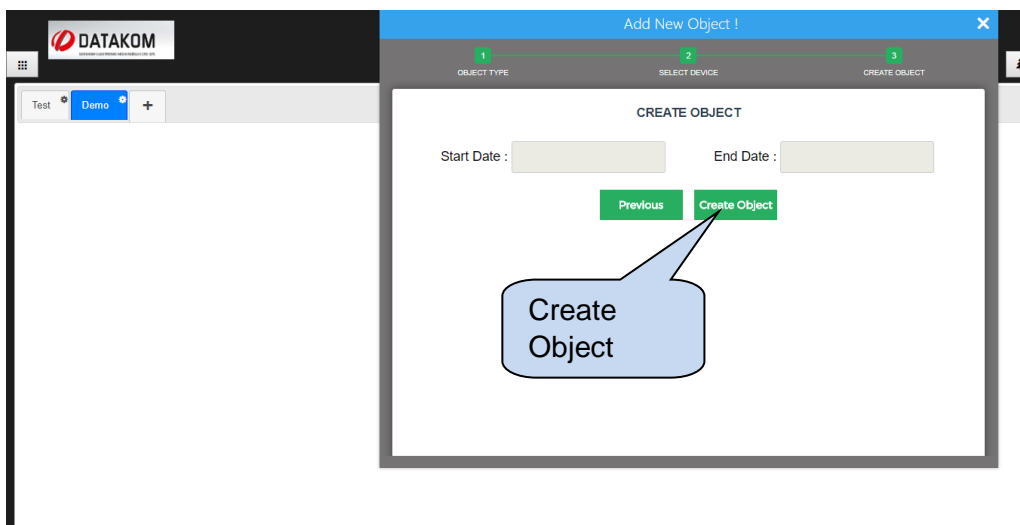

You can view all objects on the right hand side of the screen.



Sample for Daily kWh object can be seen below;

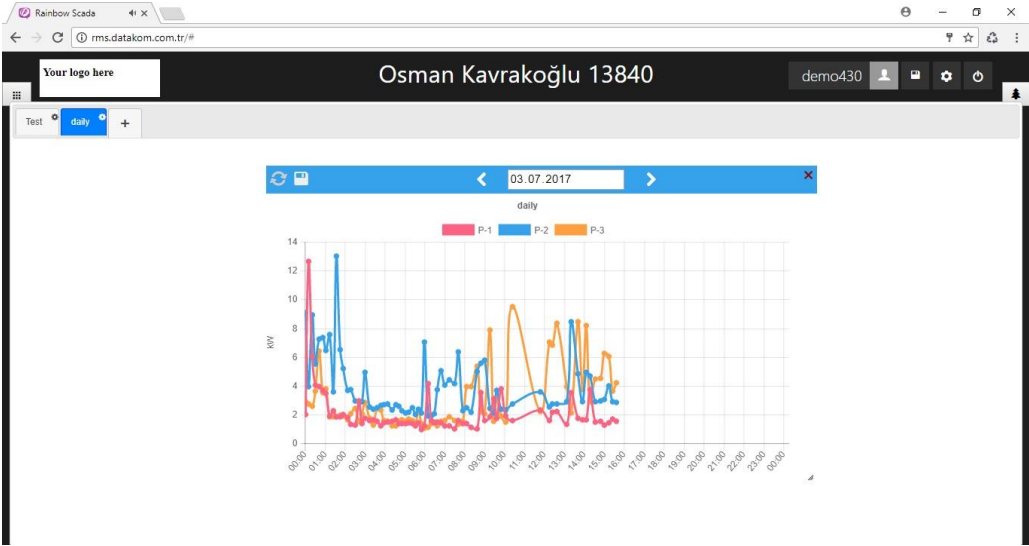

5.3.15.3 Arithmetic Object

The arithmetic object allows users to perform arithmetic operations between measured parameters. Moreover, arithmetic operations can be performed between two or more objects which are of arithmetic type.

Once a device is specified and object type is selected as arithmetic, values must be placed from device property column to the object items column one by one. Arithmetic operation between values must be selected after each item placed to the object items column.

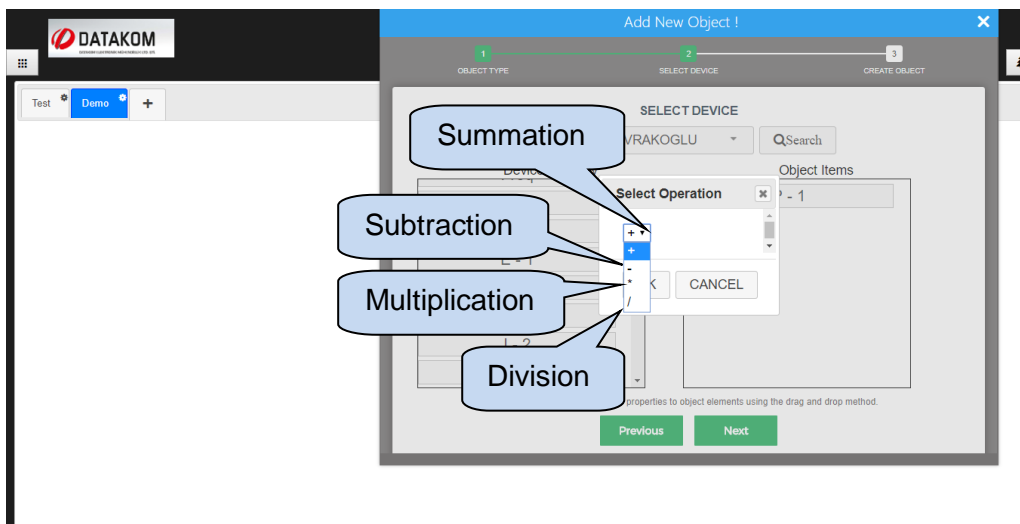

Click next once arithmetic operation is completed.

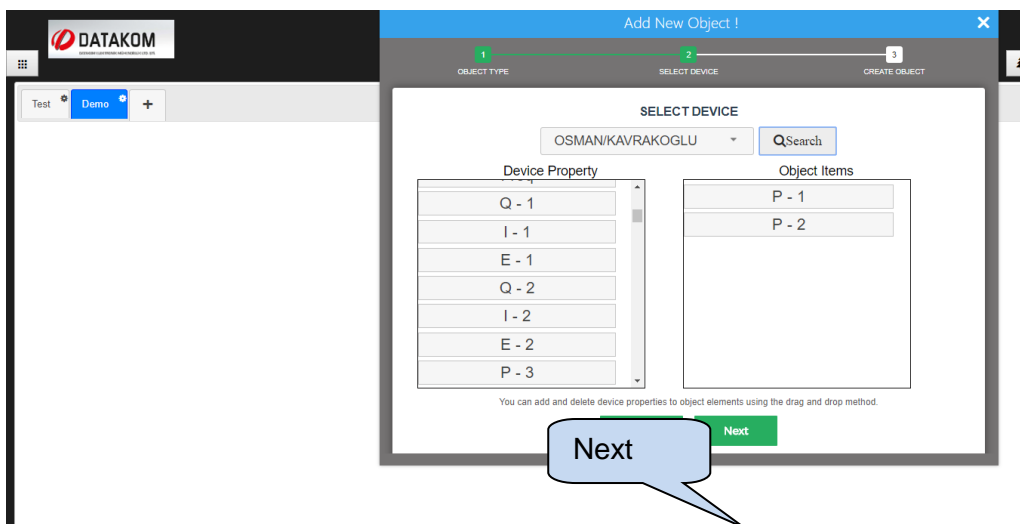

Unit of measurement must be specified on following screen;

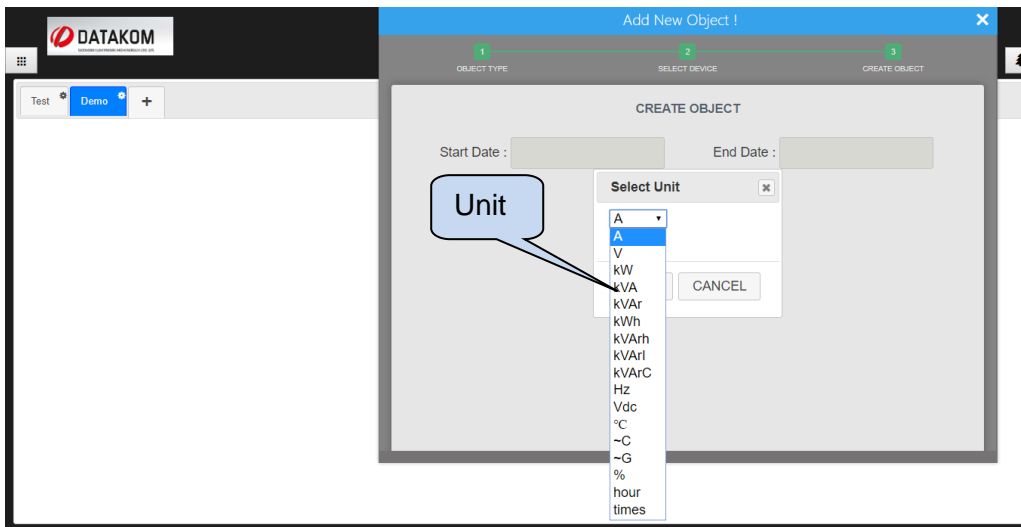

Click create object button.

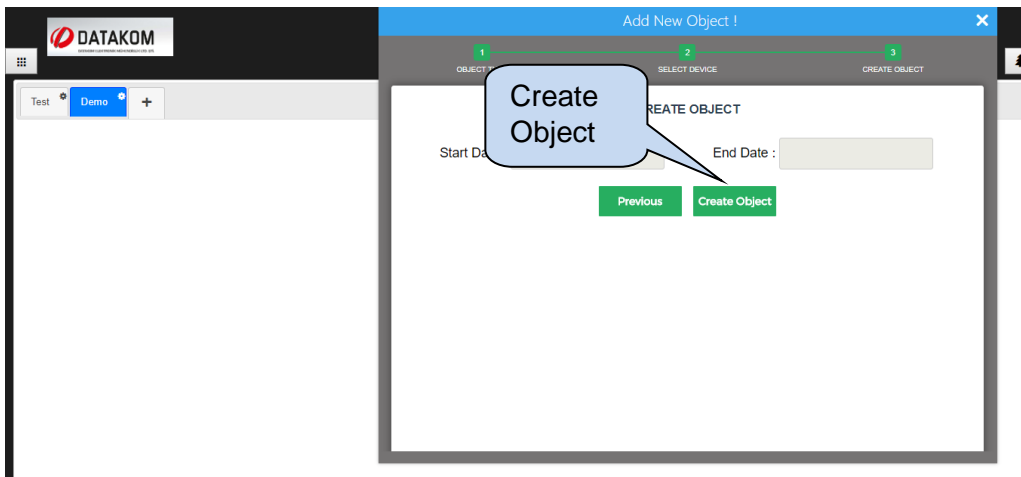

It is also possible to perform arithmetic operation between two objects that are arithmetic type. Instead of choosing the device during object creation, **Object List** must be chosen. Once object list is selected, click search button to list all available objects.

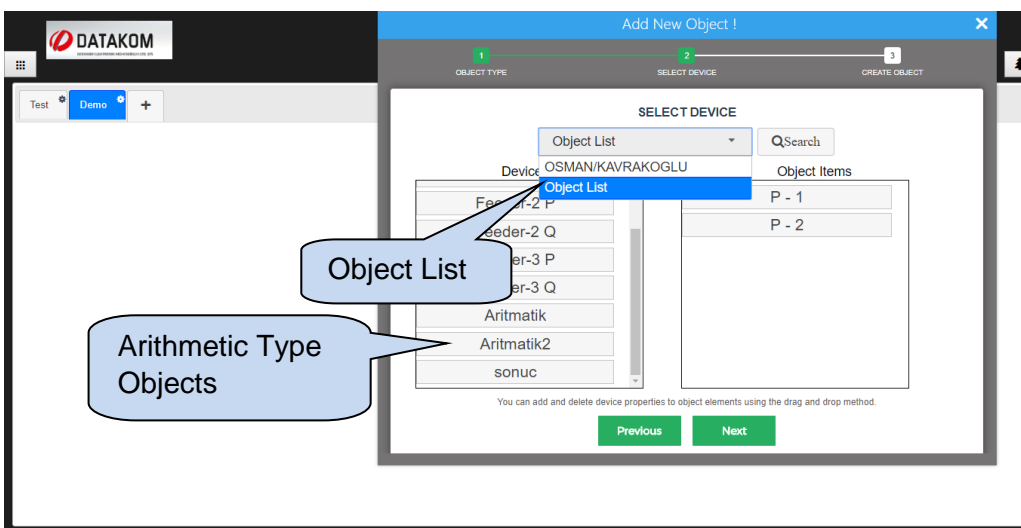

New object can be created by arithmetic operation of two objects. Two objects are added together to represent an object named “result”, which holds the sum of two arithmetic type objects;

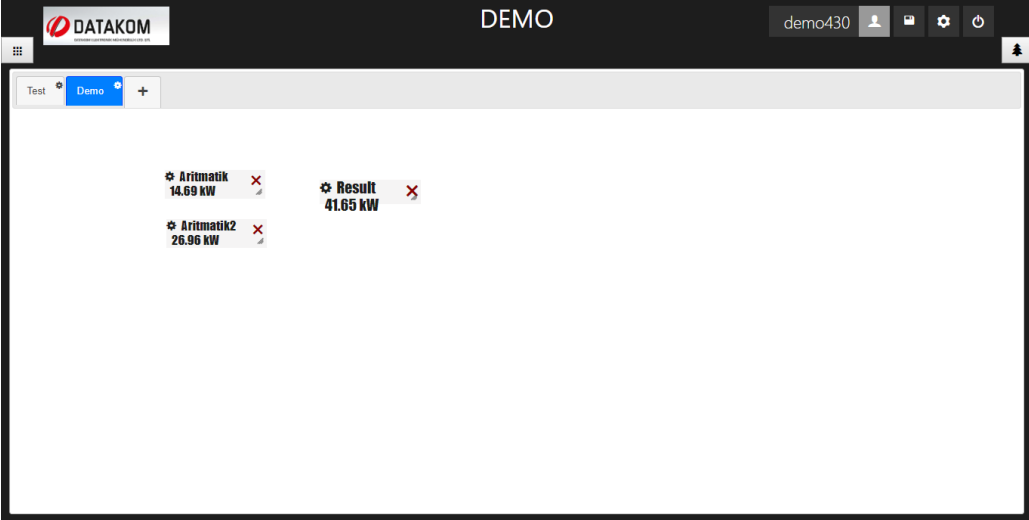

5.3.15.4 Consumption Object

Consumption object calculates active and reactive power consumption per day, per week or per month. First of all, it is required to specify time interval for active and reactive power calculation.

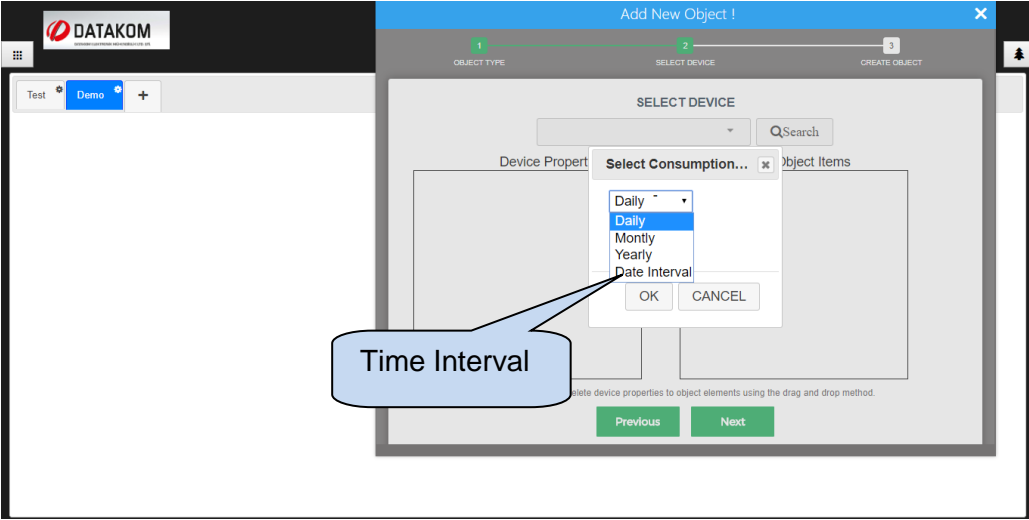

After that, reactive or active power must be selected.

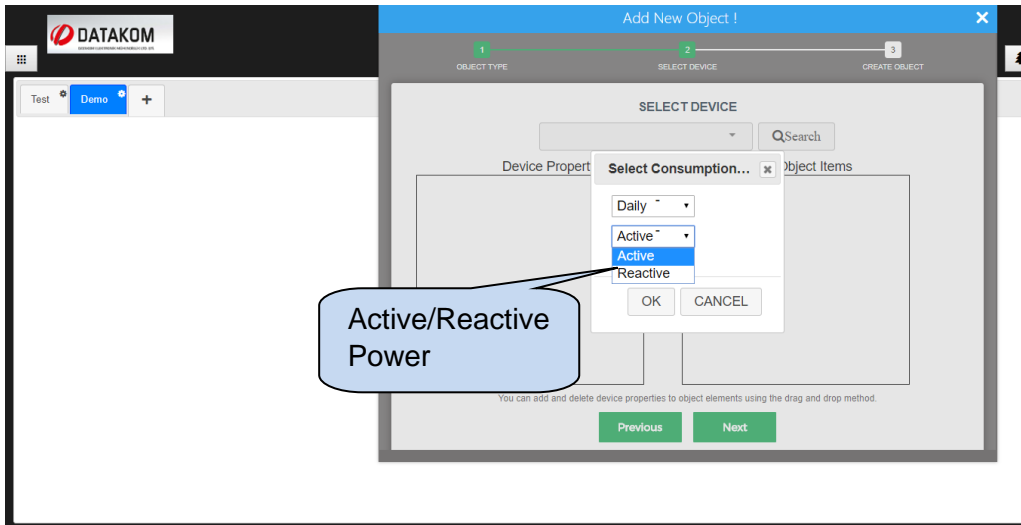

List of available measurement should be created on the **device property** column, and required measurements must be transferred to the **object items** column.

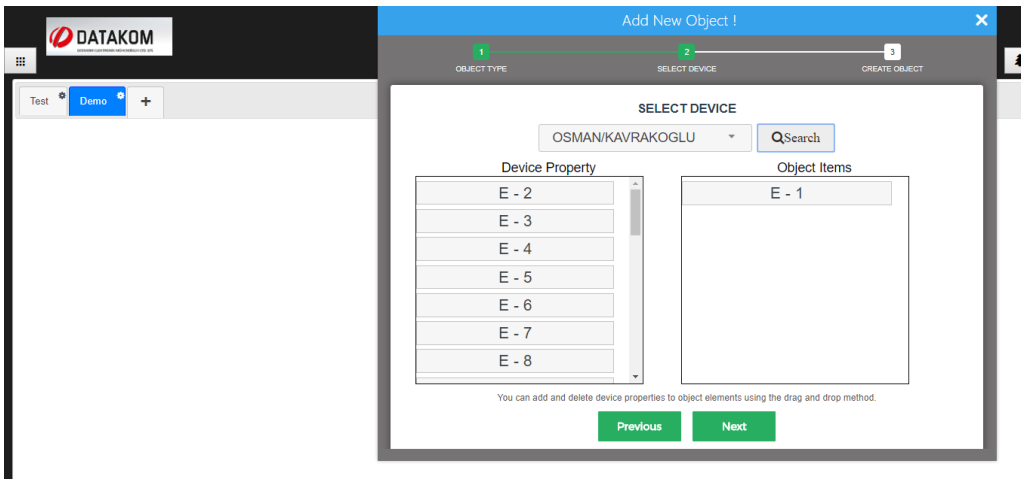

Once **consumption object** is created and placed on the remote monitoring screen, it displays consumption for given time interval.

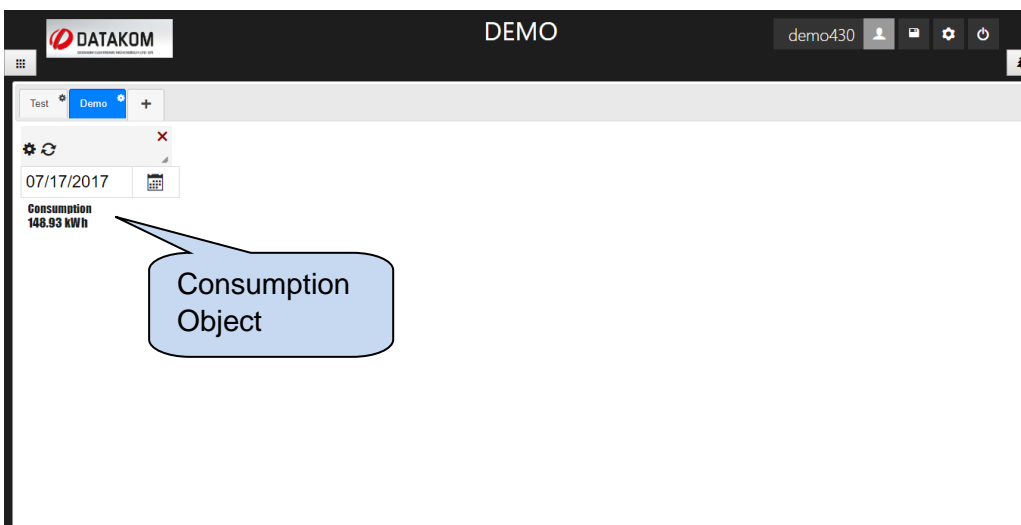

5.3.15.5 Multiple Value Chart Object

Multiple value chart object allows users to create graphs that consist of different types of measurements. Once object name is typed, and object type is selected as multiple value chart, values must be placed from device property column to the object items column one by one.

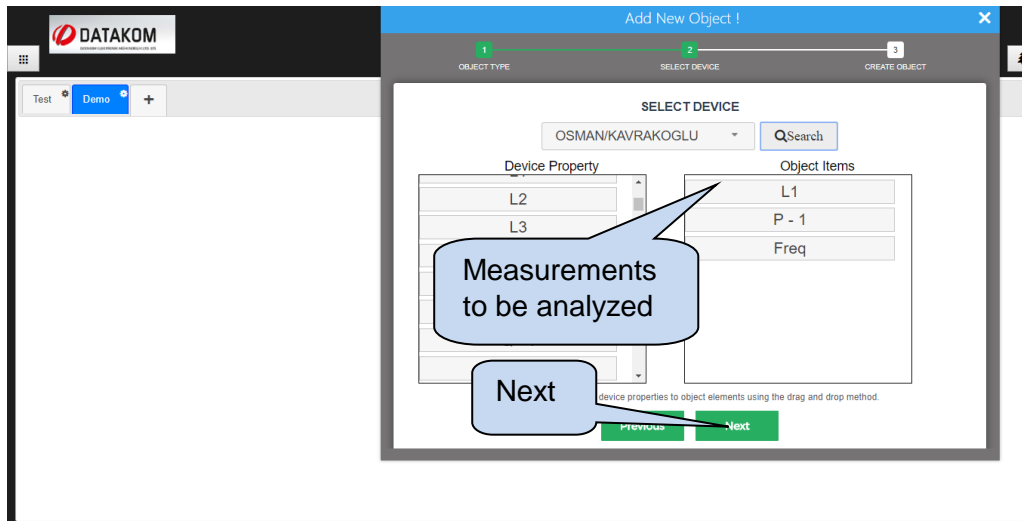

Start date and end date of the analysis must also be specified. After that, click **create object** button.

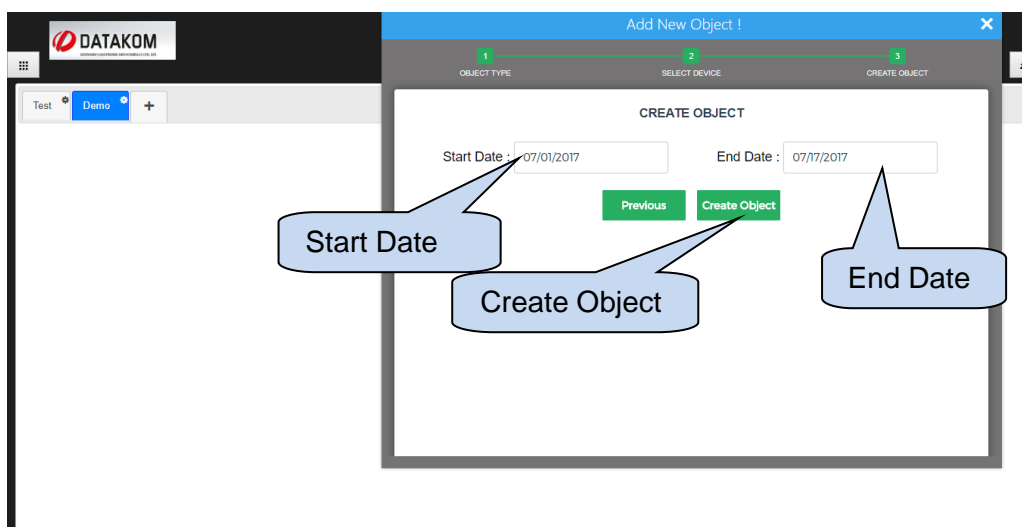

Once multiple value chart object is placed on the remote monitoring screen, it will display a graph of specified measurement values.

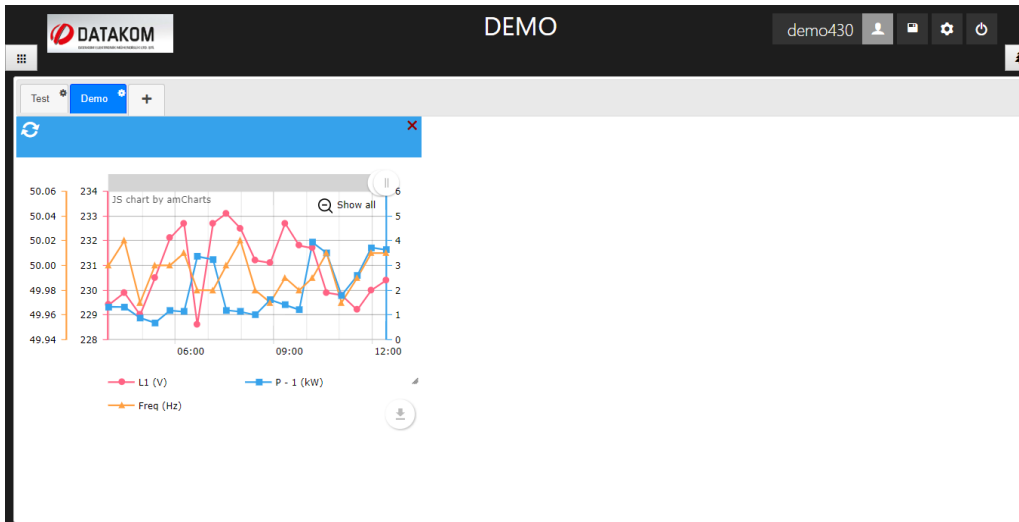

5.3.15.6 Table Object

Table object creates table with selected measurement values. Once object name is typed, and object type is selected as table, column number must be specified. After that, values must be placed from device property column to the object items column one by one.

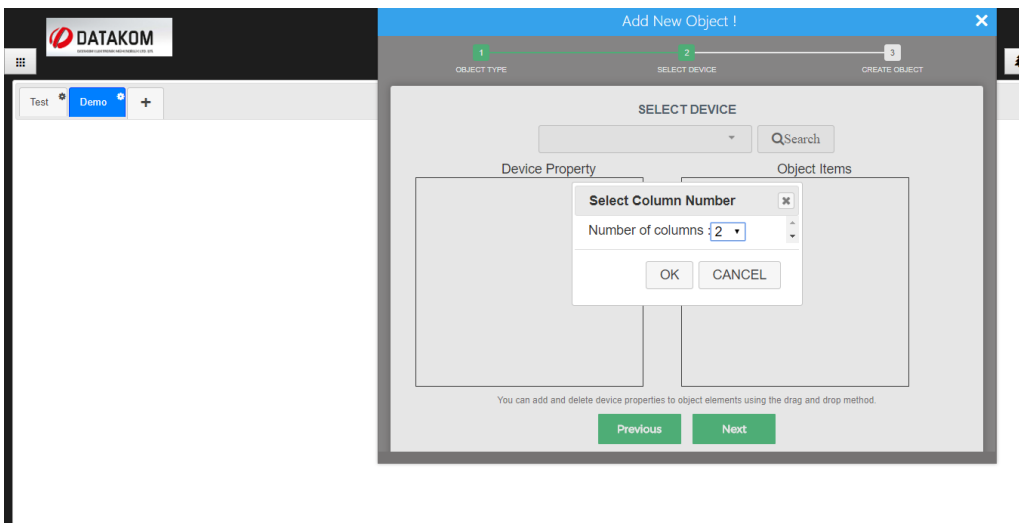

Column number that values must place on the table should also be specified when it is transferred from **device property column** to **object items column**.

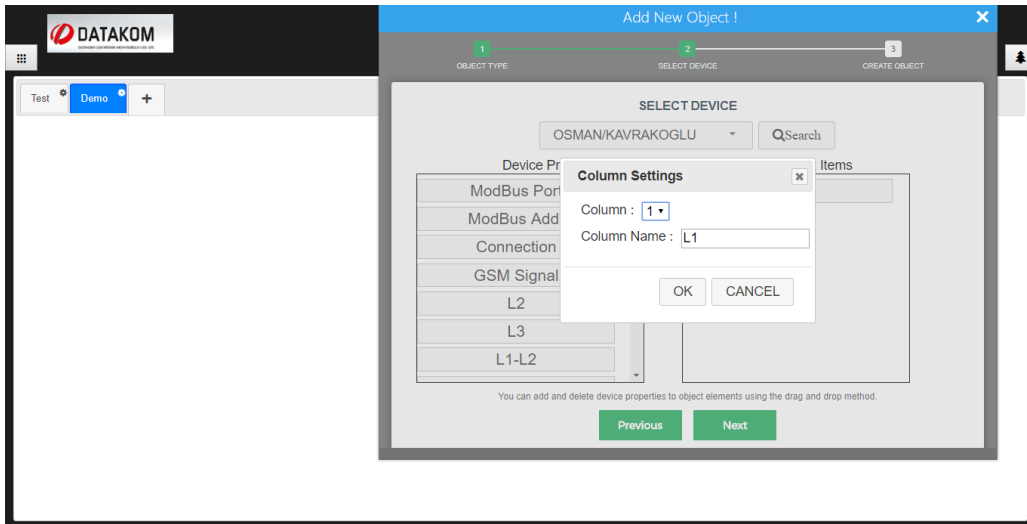

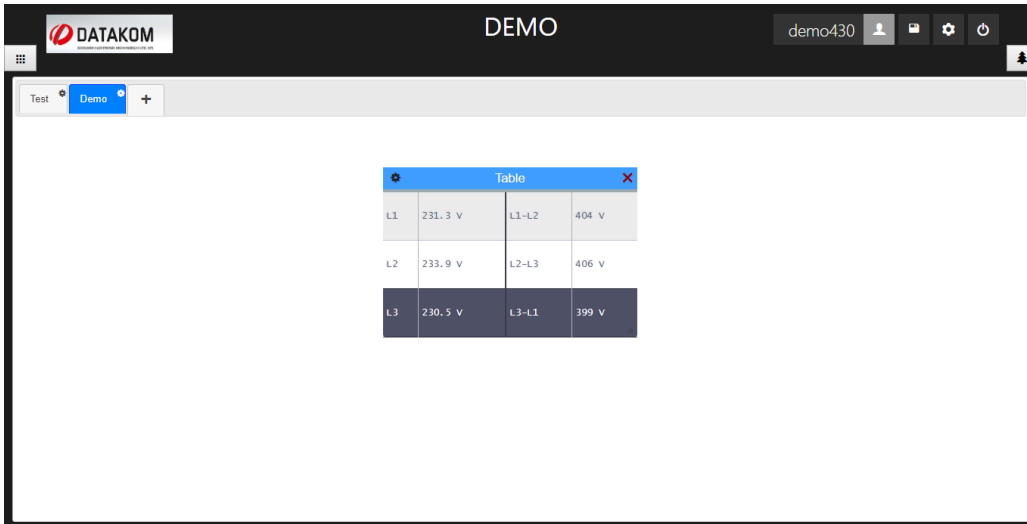

As it can be seen below, table object will create a table by using measurement values.

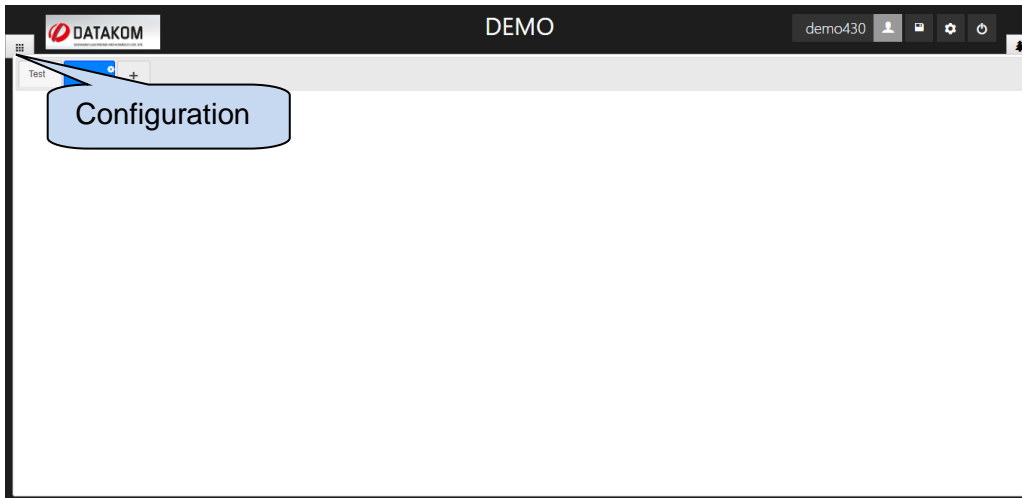

5.3.16 Config Mode Disable

Click  button to disable config mode.



A new window will appear at the left hand side of the screen. Click  button to switch to the monitoring mode from config mode. Therefore, you will not be able make any changes without enabling config mode again.

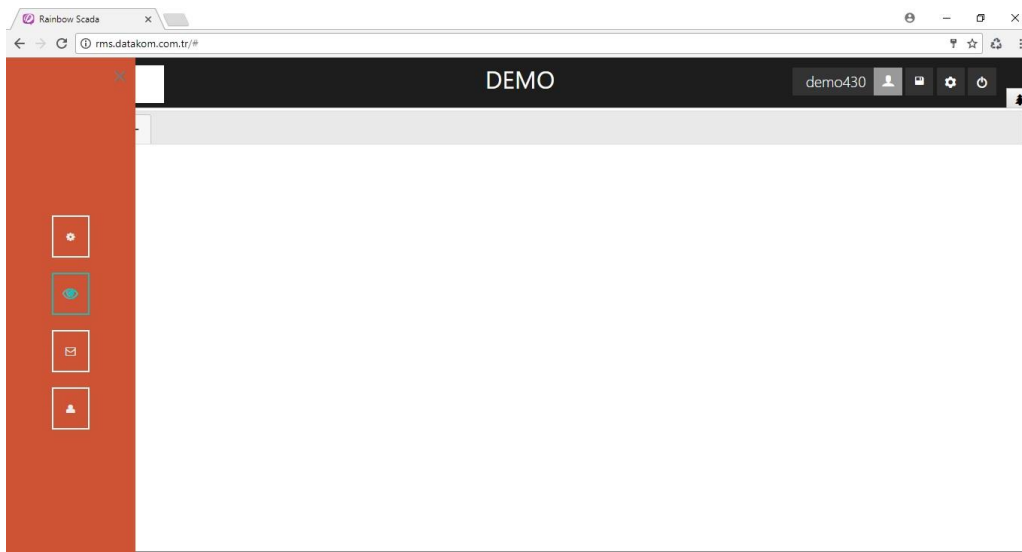

5.3.17 Sample Projects

Few screenshots of the projects that are created with Rainbow Scada are listed for demonstration purposes.

KOMPANZASYON ANALİZÖR EKRANI

L1		I1		P1	
L2		I2		P2	
L3		I3		P3	
Q1		Cos1		ΣP	
Q2		Cos2		ΣQ	
Q3		Cos3		PF	



REAKTİF ORANLAR

	GÜNLÜK	AYLIK
İn		
Cap		

ŞEBEKE

Transfer

JENERATÖR

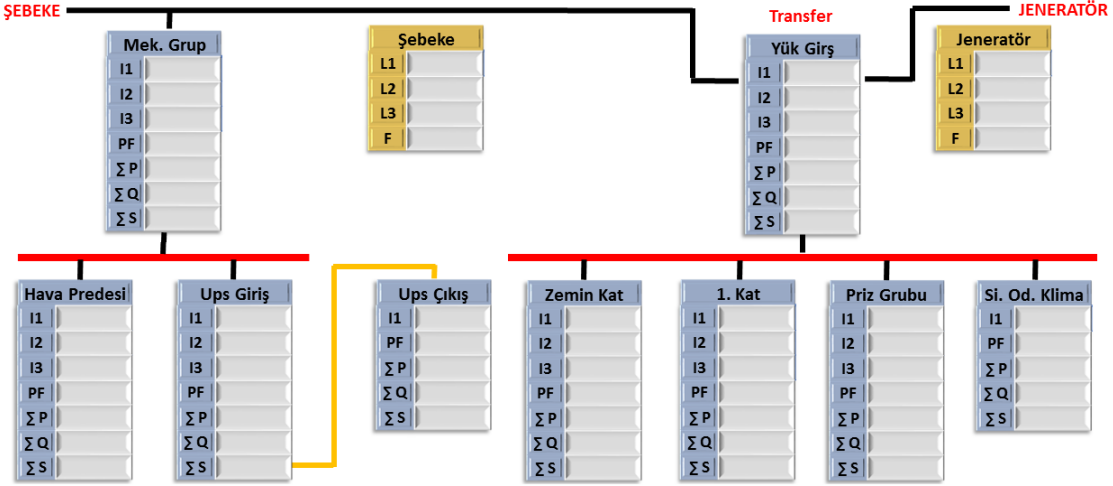

Mek. Grup

Şebeke

Yük Giriş

Jeneratör

Hava Predesi

Ups Giriş

Ups Çıkış



Zemin Kat

1. Kat



Priz Grubu

Si. Od. Klima

Sistem Odası



Giriş Kat



Günlük Aylık Yıllık



Günlük Aylık Yıllık



Günlük Aylık Yıllık



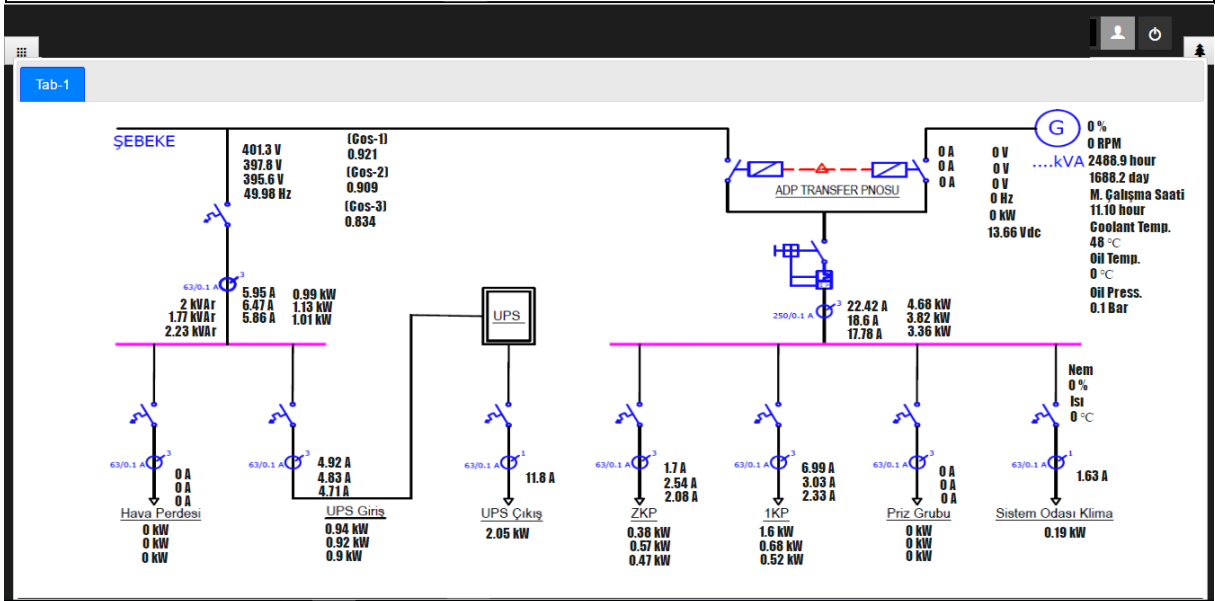
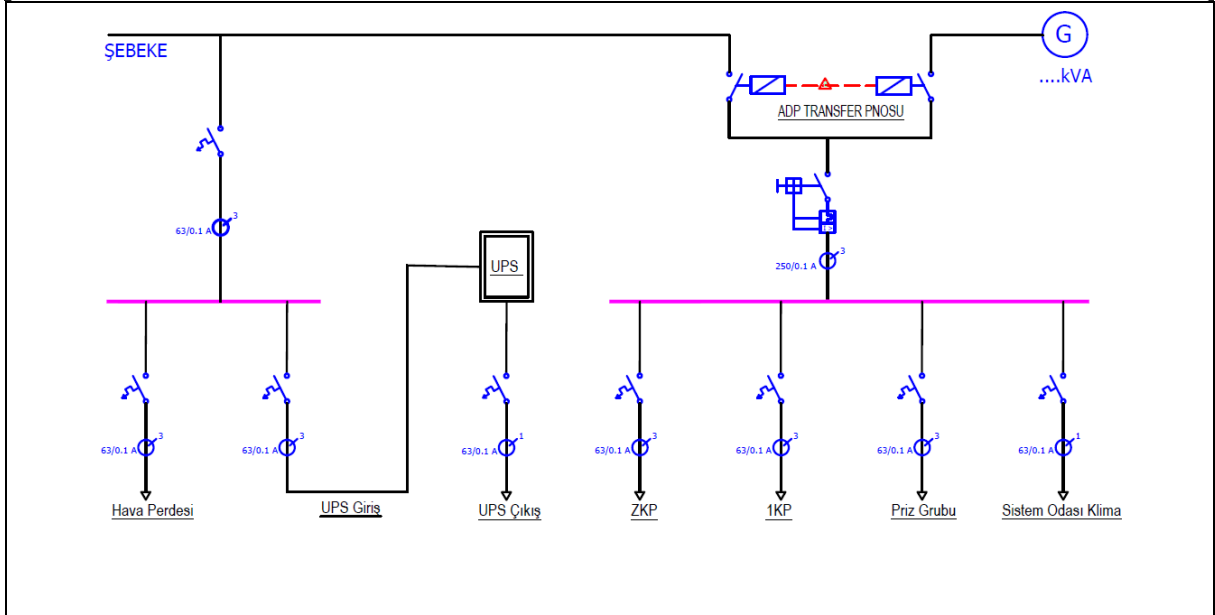
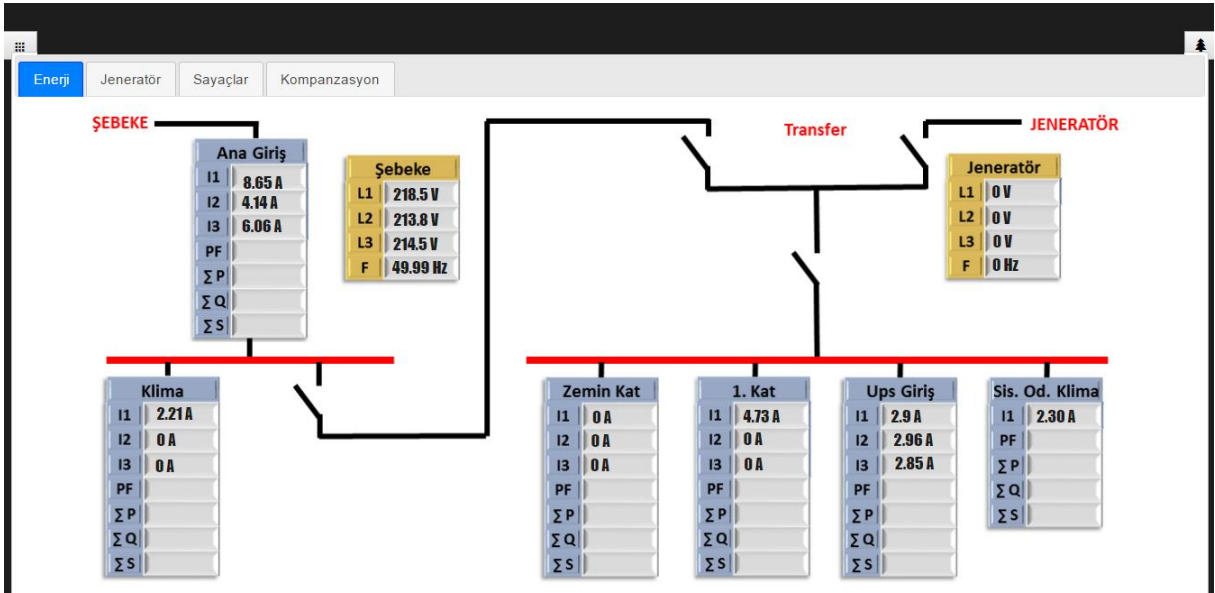

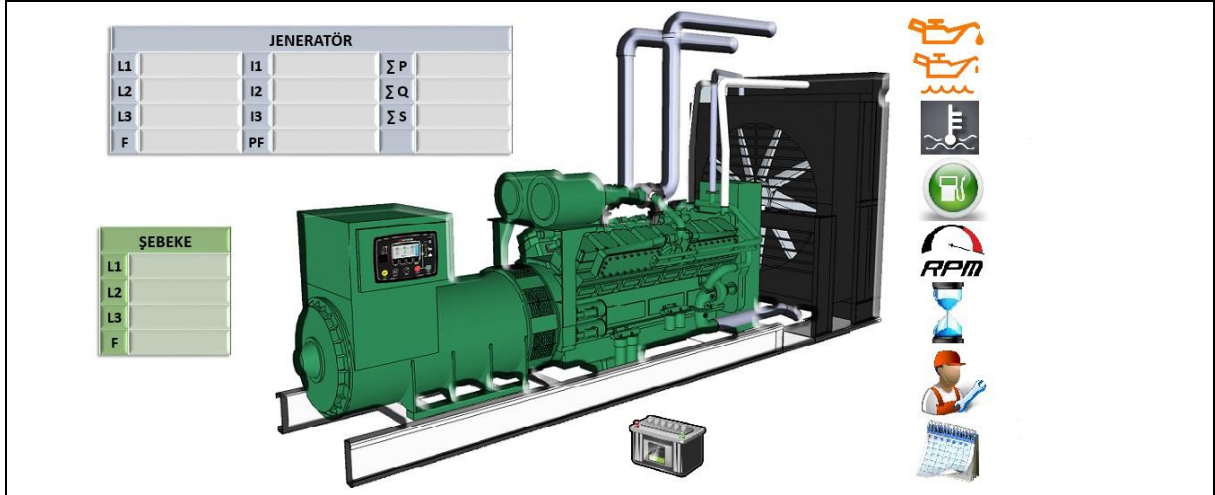
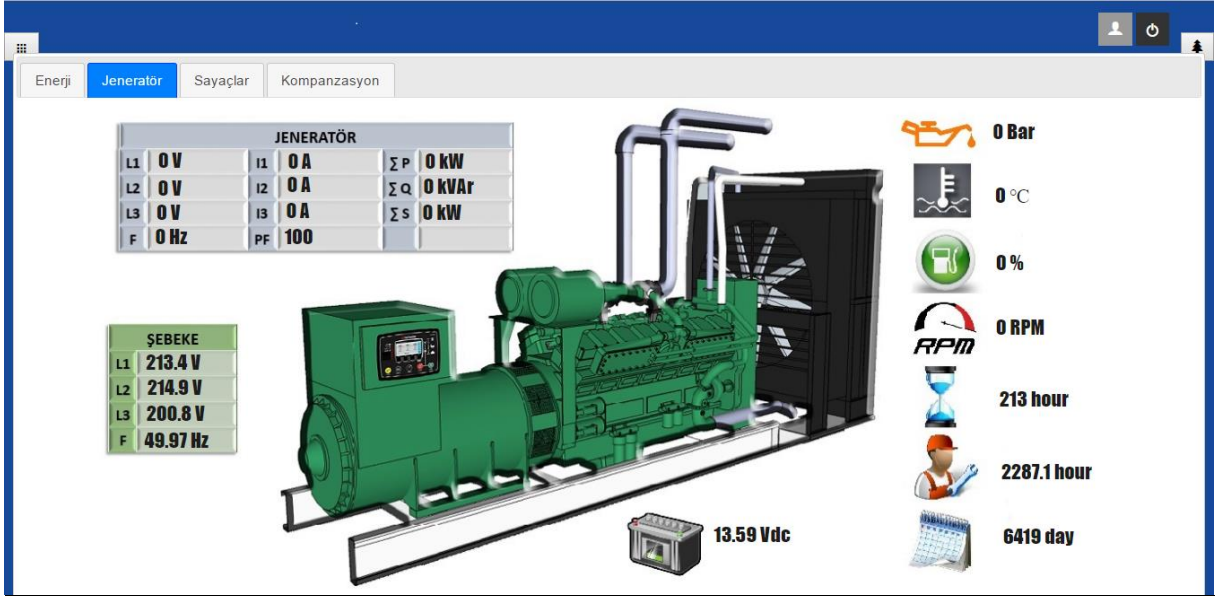

Enerji Jeneratör Sayaçlar **Kompanzasyon** Yönetim

KOMPAZASYON ANALİZÖR EKRANI

L1	220.5 V	I1	5.30 A	P1	1.03 KW
L2	219.8 V	I2	8 A	P2	1.74 KW
L3	216.3 V	I3	11.20 A	P3	2.41 KW
Q1	-0.38 kVAr	Cos1	-0.93	Σ P	5.18 KW
Q2	0.19 kVAr	Cos2	0.994	Σ Q	-0.02 kVAr
Q3	0.17 kVAr	Cos3	0.997	PF	-0.999



REAKTİF ORANLAR

	GÜNLÜK	AYLIK
İn	4.3 %	4.3 %
Cap	6 %	10.60

Enerji Jeneratör **Sayaçlar** Kompanzasyon

Sistem Odası

 **14.95 °C**

 **54.35 %**

Giriş Kat

 **14.95 °C**

 **54.35 %**

 **Günlük** **Aylık** **Yıllık**

 **Günlük** **Aylık** **Yıllık**

 **Günlük** **Aylık** **Yıllık**