

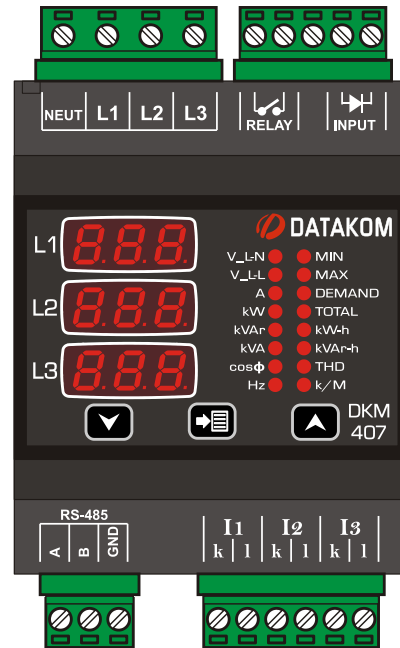

# DKM-407 DIN RAIL TYPE NETWORK ANALYZER



## DESCRIPTION

The DKM-407 is a DIN rail mounted precision and low cost unit allowing measurement and remote monitoring of AC parameters of a distribution panel.

The unit is supplied between L1 and Neutral terminals. Thanks to the supply range of 85-305V, it is not affected by voltage fluctuations and is capable of operating in any network.

The unit features an 32-bit ARM core microcontroller. With a sampling rate of 4096s/s it reaches 0.5% precision.

The unit provides 1 programmable digital input and 1 programmable relay output. Input/output functions are selected from a list.

The isolated RS-485 MODBUS RTU data port is not affected by ground potential differences.

Program parameters may be uploaded from a PC.

## FEATURES

- **True RMS measurements**
- **0.5 % measurement precision**
- **Total harmonic distortion display**
- **Demand, Min and Max records**
- **Fully isolated RS-485 serial port**
- **MODBUS-RTU communications**
- **Programmable relay output**
- **Energy pulse output capability**
- **Isolated, programmable digital input**
- **kW and kVA energy counters**
- **Hours run counter**
- **VT ratio for medium voltage applications**
- **Front panel programming**
- **Wide operating temperature range**
- **2 part connectors**



## **SAFETY NOTICE**

**Failure to follow below instructions will result in death or serious injury**



- **Electrical equipment should be installed only by qualified specialist. No responsibility is assured by the manufacturer or any of its subsidiaries for any consequences resulting from the non-compliance to these instructions.**
- **Check the unit for cracks and damages due to transportation. Do not install damaged equipment.**
- **Do not open the unit. There is no serviceable parts inside.**
- **Fuses must be connected to phase voltage inputs, in close proximity of the unit.**
- **Fuses must be of fast type (FF) with a maximum rating of 6A.**
- **Disconnect all power before working on equipment.**
- **When the unit is connected to the network do not touch terminals.**
- **Short circuit terminals of unused current transformers.**
- **Any electrical parameter applied to the device must be in the range specified in the user manual.**
- **Do not try to clean the device with solvent or the like. Only clean with a dry cloth.**
- **Verify correct terminal connections before applying power.**



**Current Transformers must be used for current measurement.**

**No direct connection allowed.**

## TABLE OF CONTENTS

### Section

- 1. INSTALLATION**
  - 1.1. FRONT PANEL VIEW**
  - 1.2. MECHANICAL INSTALLATION**
  - 1.3. ELECTRICAL INSTALLATION**
- 2. PUSHBUTTON FUNCTIONS**
- 3. DISPLAY NAVIGATION**
- 4. DEVICE CONFIGURATION**
  - 4.1. INTRODUCTION**
  - 4.2. RESETTING DEMAND VALUES**
  - 4.3. RESETTING ENERGY COUNTERS**
  - 4.4. RESETTING THE HOUR COUNTER**
  - 4.5. RESETTING ALARMS**
  - 4.6. SETTING THE DEFAULT SCREEN**
  - 4.7. SETTING THE CURRENT TRANSFORMER RATIO**
  - 4.8. SETTING THE VOLTAGE TRANSFORMER RATIO**
  - 4.9. SETTING HIGH AND LOW VOLTAGE LIMITS**
  - 4.10. SETTING HIGH AND LOW FREQUENCY LIMITS**
  - 4.11. SETTING THE OVERCURRENT LIMIT**
  - 4.12. SETTING HIGH AND LOW ACTIVE POWER LIMITS**
  - 4.13. SETTING HIGH AND LOW REACTIVE POWER LIMITS**
  - 4.14. SETTING HIGH AND LOW POWER FACTOR LIMITS**
  - 4.15. CONFIGURING THE DIGITAL INPUT**
  - 4.16. CONFIGURING THE RELAY OUTPUT**
  - 4.17. CONFIGURING THE ALARM DELAY**
  - 4.18. MODBUS PARAMETERS**
  - 4.19. ENERGY PULSE OUTPUT (kWh, kVArh) PARAMETERS**
  - 4.20. DISPLAYING THE FIRMWARE VERSION**
  - 4.21. CALIBRATION**
  - 4.22. LAMP TEST**
- 5. MODBUS COMMUNICATIONS**
  - 5.1. DESCRIPTION**
  - 5.2. COMMANDS**
  - 5.3. PROGRAM PARAMETERS**
  - 5.4. MEASUREMENTS AND CONTROLLER RECORDS**
- 6. TECHNICAL SPECIFICATIONS**

## 1. INSTALLATION

### **Before installation:**

- Read the user manual carefully, determine the correct connection diagram.
- Install the unit to the DIN rail.
- Make electrical connections with plugs removed from sockets, then place plugs to their sockets.
- Note that the power supply terminal is separated from measurement terminals.

### **Below conditions may damage the device:**

- Incorrect connections.
- Incorrect power supply voltage.
- Voltage at measuring terminals beyond specified range.
- Current at measuring terminals beyond specified range.
- Connecting or removing data terminals when the unit is powered-up.
- Overload or short circuit at relay outputs
- Voltage applied to digital inputs over specified range.
- High voltage applied to communication port.



**Current Transformers must be used for current measurement.**

**No direct connection allowed.**

### **Below conditions may cause abnormal operation:**

- Power supply voltage below minimum acceptable level.
- Power supply frequency out of specified limits
- Phase order of voltage inputs not correct.
- Current transformers not matching related phases.
- Current transformer polarity incorrect.

1.1 FRONT PANEL VIEW

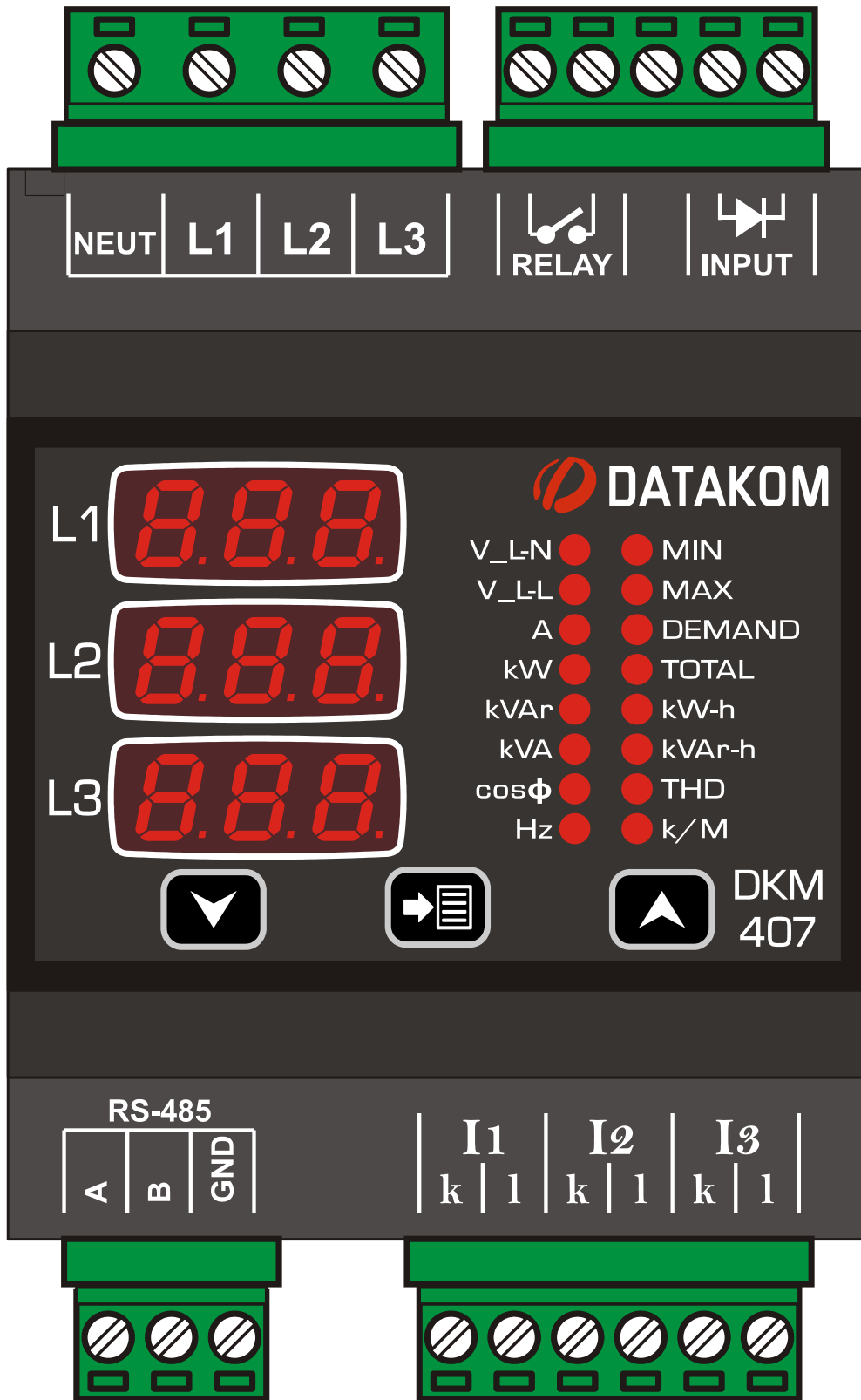

## 1.3 ELECTRICAL INSTALLATION



**Do not install the unit close to high electromagnetic noise emitting devices like contactors, high current busbars, switchmode power supplies and the like.**

Although the unit is protected against electromagnetic disturbance, excessive disturbance can affect the operation, measurement precision and data communication quality.

- **ALWAYS** remove plug connectors when inserting wires with a screwdriver.
- Fuses must be connected to phase voltage inputs, in close proximity of the unit.
- Fuses must be of fast type (FF) with a maximum rating of 6A.
- Use cables of appropriate temperature range.
- Use adequate cable section, at least 0.75mm<sup>2</sup> (AWG18).
- For current transformer inputs, use at least 1.5mm<sup>2</sup> section (AWG15) cable.
- The current transformer cable length should not exceed 1.5 meters. If longer cable is used, increase the cable section proportionally.
- Follow national rules for electrical installation.
- Current transformers must have 5A output.



**Current Transformers must be used for current measurement.**





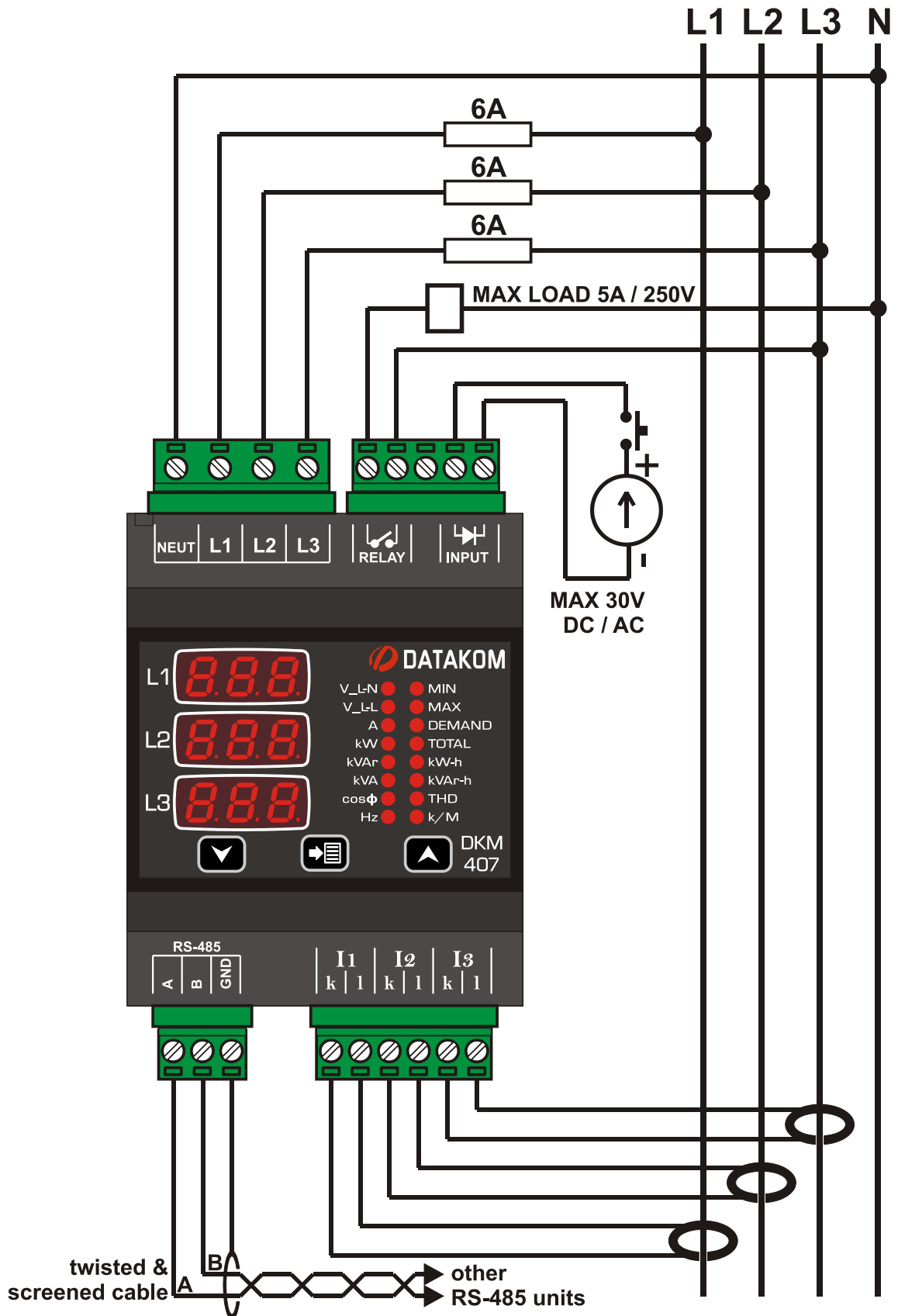

**No direct connection allowed.**

1.4 CONNECTION DIAGRAM



## 2. PUSHBUTTON FUNCTIONS



Three buttons on the front panel provide access to configuration and measurement screens.

BUTTON	FUNCTION
	<p><b><u>Selects display context</u></b></p> <ul style="list-style-type: none"> <li>• THD display</li> <li>• Minimum values display</li> <li>• Maximum values display</li> <li>• Demand display</li> <li>• If all leds are off then actual measurements display.</li> </ul>
	<p><b><u>HELD PRESSED FOR 5 SEC:</u></b> resets min-max values and displays minimum phase-to-neutral voltages.</p>
	<p>Upper screen or Increase related value (configuration mode)</p>
	<p>Lower screen or Decrease related value (configuration mode)</p>
 	<p><b><u>HELD PRESSED TOGETHER FOR 2 SEC:</u></b> Enters configuration mode.</p>
	<p><b><u>IF NO BUTTON PRESSED FOR 5 MINUTES:</u></b> returns to the main display screen</p>

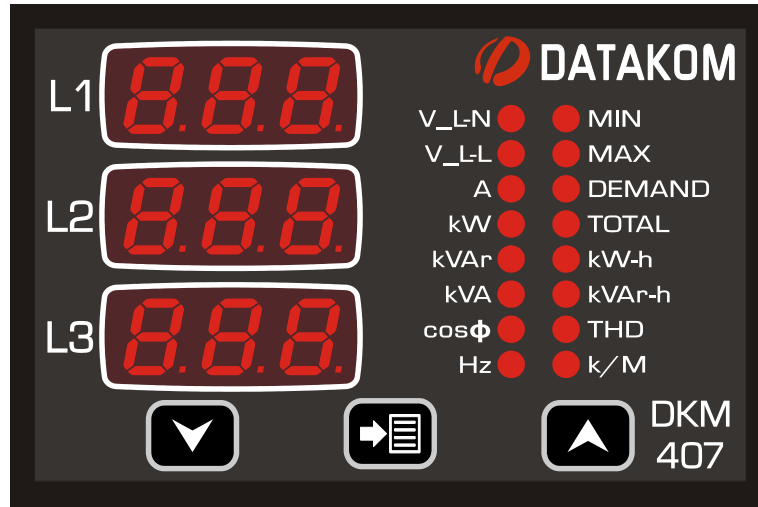

### 3. DISPLAY NAVIGATION



The  button will select the display context and   buttons will navigate between possible values of this context.

**Kilo/Mega (k/M) led** will turn on if the displayed value is in kA/kV/MW/MVA/MVAr.  
**TOTAL led** will turn on when displaying total values.

Normally, the led indicating the values on display will be on. Other leds will turn off. If total working hours is displayed then only the TOTAL led will turn on.

When displaying voltage, current, THD, power factor, etc.. each display will show the value related to one phase. When total values are displayed, depending on the length of the data to display, all 3 displays may be used.

**Display of currents:** If the greatest current value to display is larger than 999A then the **k/M** (kilo/mega) led will turn on, otherwise it will turn off. When the k/M led is off, if the greatest current value is below 100A then currents will be displayed with 0.1A precision, otherwise they will be displayed with 1A precision. When the k/M led is on, if the greatest current value is below 10kA then currents will be displayed with 0.01kA precision, otherwise they will be displayed with 0.1kA precision.

**Display of voltages:** If the greatest voltage value to display is larger than 999V then the **k/M** (kilo/mega) led will turn on, otherwise it will turn off. When the k/M led is off, voltages will be displayed with 1V precision. When the k/M led is on, if the greatest voltage value is below 10kV then voltages will be displayed with 0.01kV precision, between 10kV and 99.9kV they will be displayed 0.1kV precision and above 100kV they will be displayed with 1kV precision.

**Display of kW, kVA, kVAr:** Depending on the values, they will be displayed with 0.1k or 1k or 0.01M precision.

**Display of kWh, kVArh, Hours:** Values are displayed with a precision of 0.1 k (or hour).

## 4. DEVICE CONFIGURATION

### 4.1 INTRODUCTION

In order to offer the maximum flexibility to the user, the unit has several configurable parameters.

- |   |  |
|---|--|
| <ul style="list-style-type: none"> <li>• <b>Device Configuration</b> <ul style="list-style-type: none"> <li>➤ Default display configuration</li> </ul> </li> <li>• <b>Measurement Configurations</b> <ul style="list-style-type: none"> <li>➤ Resetting Demand Values</li> <li>➤ Clearing Counters</li> <li>➤ Resetting Alarms</li> <li>➤ Setting the CT ratio</li> <li>➤ Setting the VT ratio</li> <li>➤ Setting alarm limits</li> </ul> </li> </ul> | <ul style="list-style-type: none"> <li>• <b>Input / Output Configuration</b> <ul style="list-style-type: none"> <li>➤ Input Configuration</li> <li>➤ Relay Configuration</li> <li>➤ Alarm delay</li> <li>➤ Modbus parameters</li> </ul> </li> <li>• <b>Device Calibration</b></li> </ul> |
|---|--|



In order to enter the configuration menu, hold both MENU buttons pressed for 2 seconds.



In order to exit the configuration menu, hold both MENU buttons pressed for 2 seconds. If no button is pressed, the unit will automatically close the configuration menu after 1 minute.



Parameter values are increased / decreased with MENU buttons. Holding the button pressed will increase / decrease with larger steps.



Pressing the SET button will save the current parameter and display the next parameter.

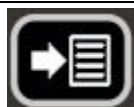

Holding the SET button pressed for 2 seconds will display the previous parameter.

## 4.2 RESETTING DEMAND VALUES

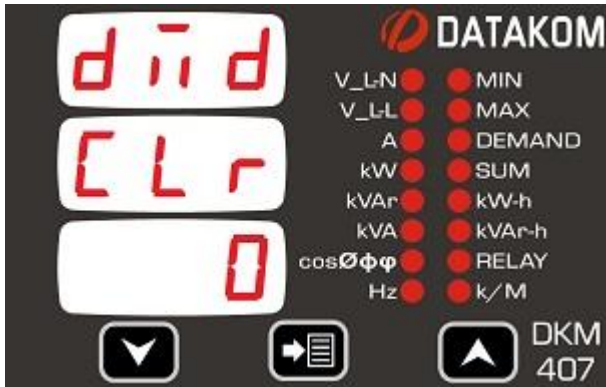

Parameter value:

**0:** No action

**1:** Reset Demand values

Setting this parameter to 1 will reset demand values.

The parameter value is not stored into memory and reads always 0.

## 4.3 RESETTING ENERGY COUNTERS

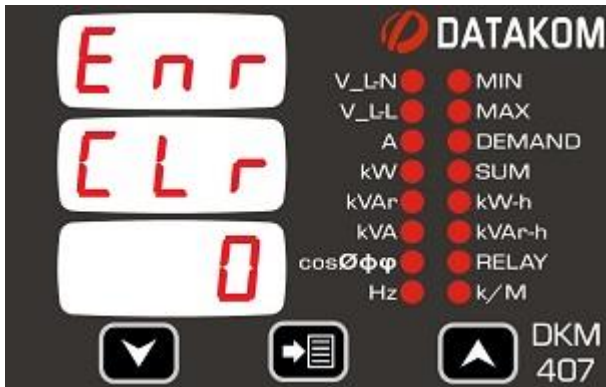

Parameter value:

**0:** No action

**1:** Reset kWh and kVArh counters

Setting this parameter to 1 will reset powermeter counters.

The parameter value is not stored into memory and reads always 0.

## 4.4 RESETTING THE HOUR COUNTER

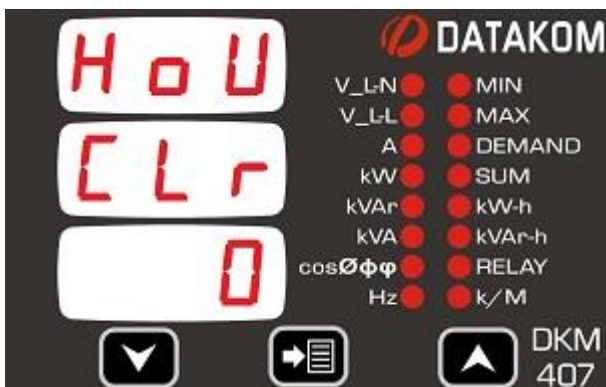

Parameter value:

**0:** No action

**1:** Reset hour counter

Setting this parameter to 1 will reset the hour counter.

The parameter value is not stored into memory and reads always 0.

## 4.5 RESETTING ALARMS

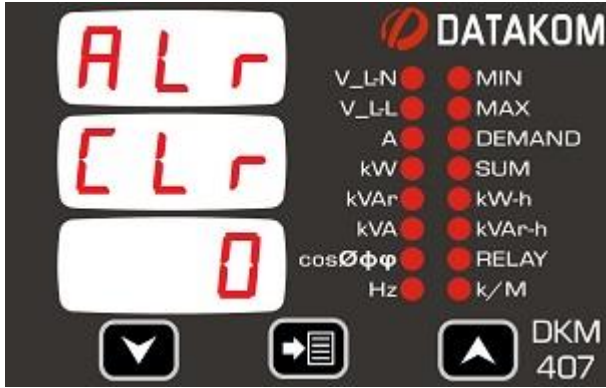

Parameter value:

**0:** No action

**1:** Reset alarms

Setting this parameter to 1 will reset existing alarms.

The parameter value is not stored into memory and reads always 0.

## 4.6 SETTING THE DEFAULT SCREEN

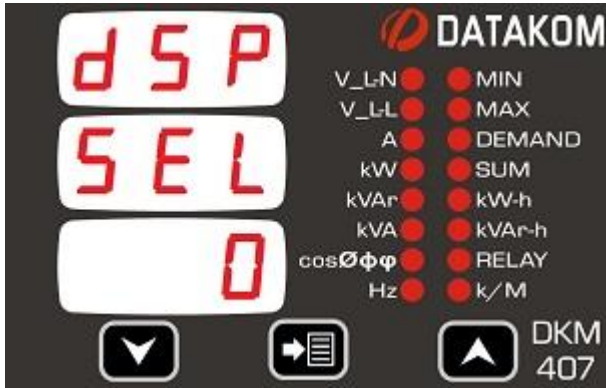

This parameter selects the default screen that the unit returns 5 minutes after any key is pressed.

Setting this parameter to 0 will cancel the default screen.

Param. değeri	Göstergeler
0	no change
1	Voltages L-N
2	Voltages L-L
3	Currents
4	Total current
5	Phase kW
6	Total kW
7	Phase kVAr
8	Total kVAr
9	Phase kVA
10	Total kVA
11	Phase cosφ
12	Total cosφ
13	Frequency
14	kWh counter
15	kVArh counter
16	Hours counter

## 4.7 SETTING THE CURRENT TRANSFORMER RATIO

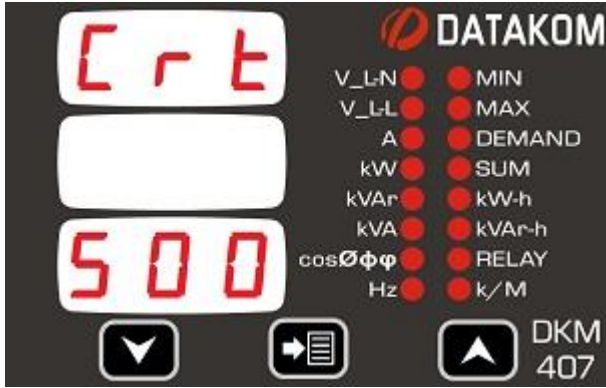

This parameter sets the primary rating of current transformers.

Current transformer secondary rating should be 5 Amps.

The factory set default value is 500/5A.  
Acceptable values are 5/5A to 5000/5A.

## 4.8 SETTING THE VOLTAGE TRANSFORMER RATIO

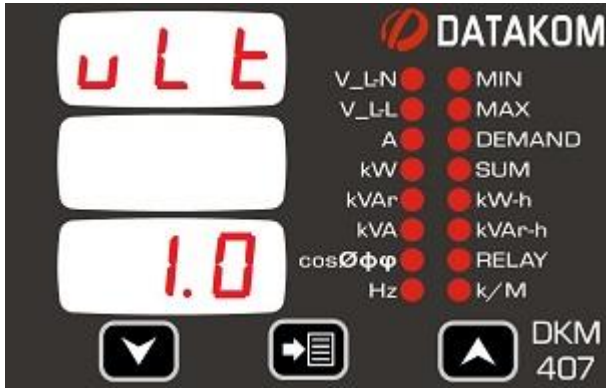

This parameter sets the ratio of voltage transformers.

All voltage and power measurements will be displayed after multiplication with this parameter.

The factory set default value is 1.0  
Acceptable values are 0.1 to 200.0

## 4.9 SETTING HIGH AND LOW VOLTAGE LIMITS

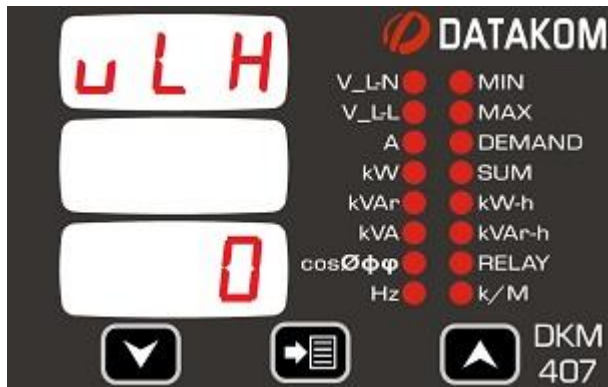

This parameter sets the high limit for high voltage alarm.

Only **phase to neutral** voltages are monitored and generate alarms.

If the parameter is set to 0 then no high voltage alarm will occur.

The factory set default value is 0

Acceptable values are 0 to 12'000volts

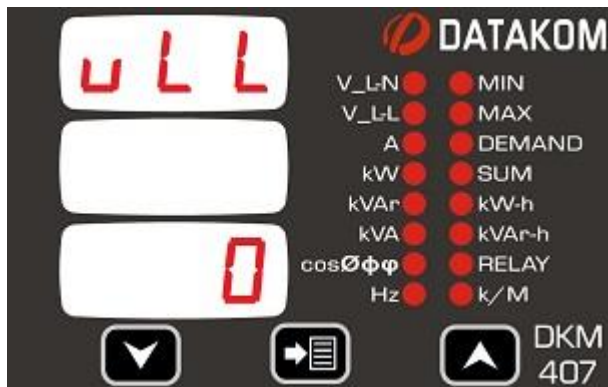

This parameter sets the low limit for low voltage alarm.

Only **phase to neutral** voltages are monitored and generate alarms.

If the parameter is set to 0 then no low voltage alarm will occur.

The factory set default value is 0

Acceptable values are 0 to 12'000volts



## 4.10 SETTING HIGH AND LOW FREQUENCY LIMITS

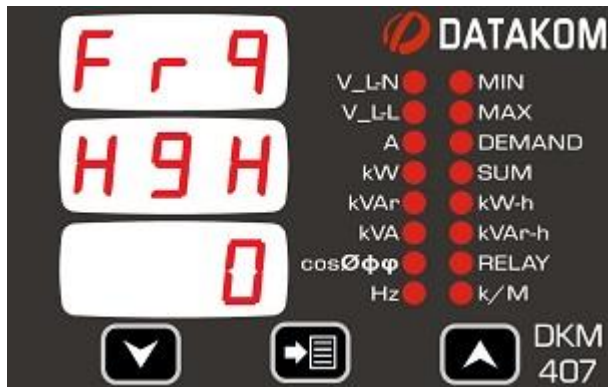

This parameter sets the high limit for high frequency alarm.

If the parameter is set to 0 then no high frequency alarm will occur.

The factory set default value is 0

Acceptable values are 0 to 400Hz

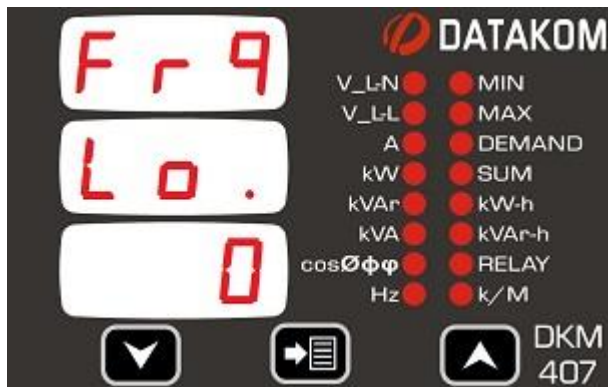

This parameter sets the low limit for low frequency alarm.

If the parameter is set to 0 then no low frequency alarm will occur.

The factory set default value is 0

Acceptable values are 0 to 400Hz.

## 4.11 SETTING THE OVERCURRENT LIMIT

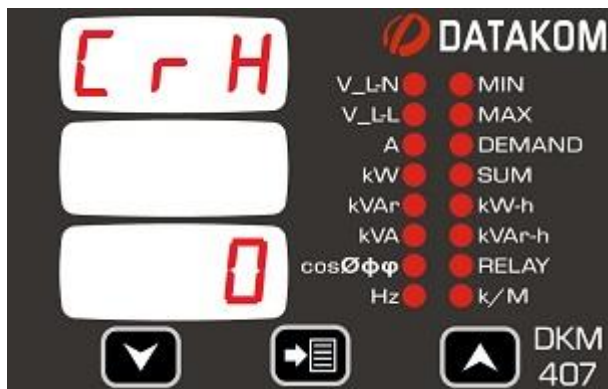

This parameter sets the high limit for overcurrent alarm.

If the parameter is set to 0 then no overcurrent alarm will occur.

The factory set default value is 0

Acceptable values are 0 to 5000Amps.

## 4.12 SETTING HIGH AND LOW ACTIVE POWER LIMITS

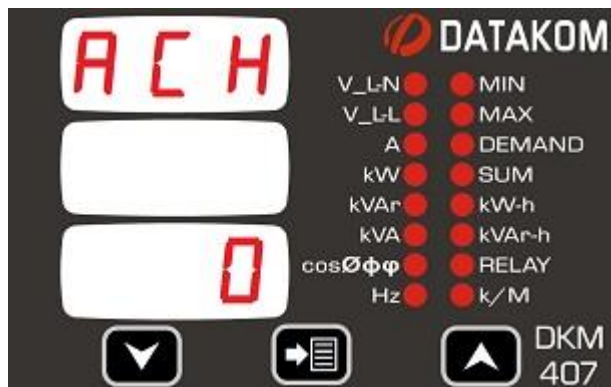

This parameter sets the high limit for excess active power alarm.

If the parameter is set to 0 then no excess active power alarm will occur.

The factory set default value is 0

Acceptable values are 0 to 6500kW.

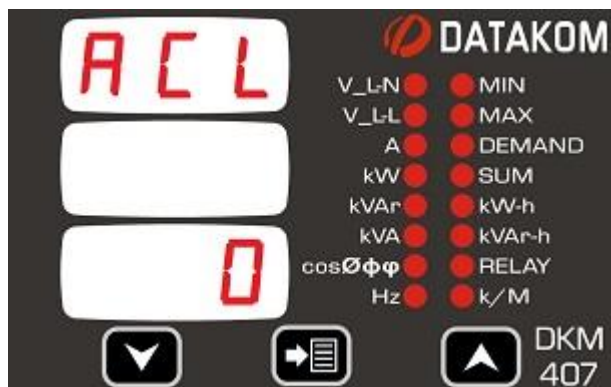

This parameter sets the low limit for low active power alarm.

If the parameter is set to 0 then no low active power alarm will occur.

The factory set default value is 0

Acceptable values are 0 to 6500kW.



### 4.13 SETTING HIGH AND LOW REACTIVE POWER LIMITS

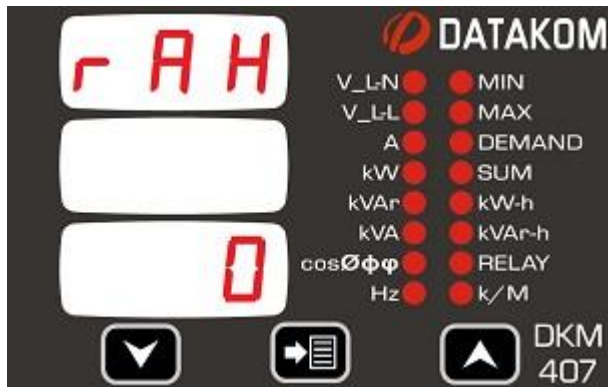

This parameter sets the high limit for excess reactive power alarm.

If the parameter is set to 0 then no excess reactive power alarm will occur.

The factory set default value is 0

Acceptable values are 0 to 6500kVA.

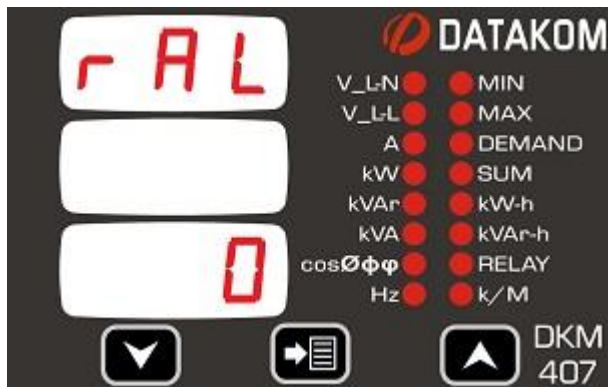

This parameter sets the low limit for low reactive power alarm.

If the parameter is set to 0 then no low reactive power alarm will occur.

The factory set default value is 0

Acceptable values are 0 to 6500kVA.

#### 4.14 SETTING HIGH AND LOW POWER FACTOR LIMITS

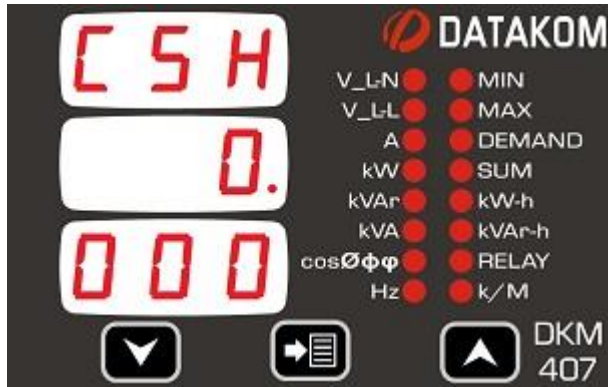

This parameter sets the high limit for high  $\cos\phi$  alarm.

If the parameter is set to 0.000 then no high  $\cos\phi$  alarm will occur.

The factory set default value is 0.000

Acceptable values are 0.000 to 1.000

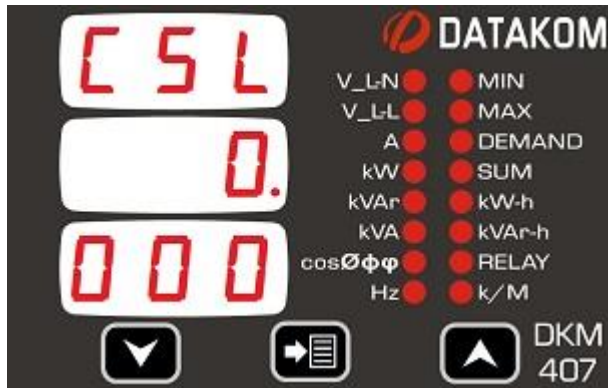

This parameter sets the low limit for low  $\cos\phi$  alarm.

If the parameter is set to 0.000 then no low  $\cos\phi$  alarm will occur.

The factory set default value is 0.000

Acceptable values are 0.000 to 1.000

## 4.15 CONFIGURING THE DIGITAL INPUT

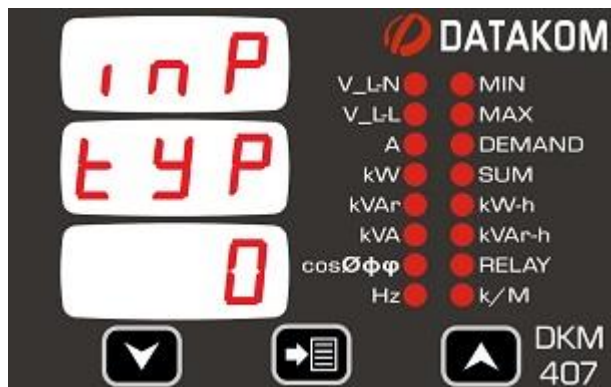

This parameter sets the active status of the digital input signal.

**0:** input active when signal applied  
**1:** input active when signal removed

The input signal is 5 to 30V AC or DC applied between terminals with the polarity shown in the connection diagram.

The factory set default value is 0.

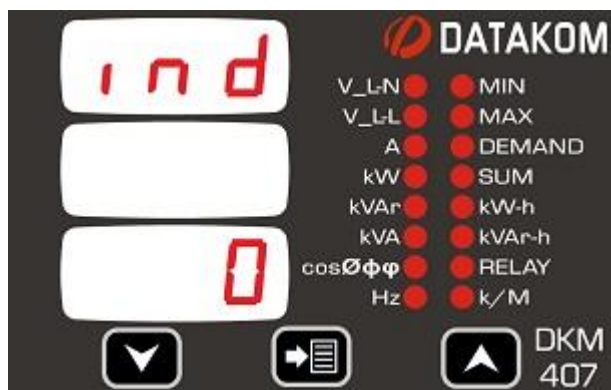

This parameter sets the detection delay of the digital input signal in milliseconds.

This delay is necessary to prevent spurious signal detection due to electrical noise.

The factory set default value is 1ms.

Acceptable values are 1 to 1000ms.

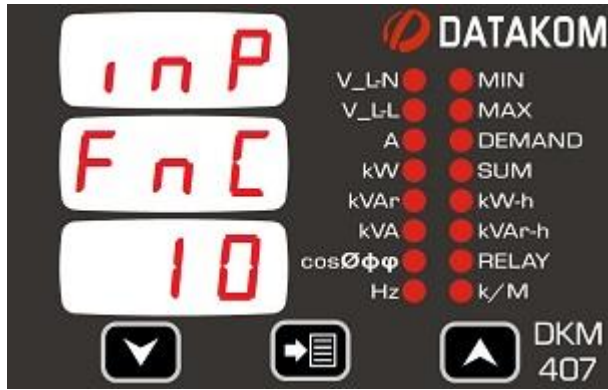

This parameter sets the function of the digital input.

The factory set default value is 11.

Value	Function when signal active	Function when signal passive
0	kWh and kVArh counters increment	no increment
1	kWh and kVArh counters increment	kWh and kVArh counters reset to zero
2	kWh, kVArh, hour counters increment	no increment
3	kWh, kVArh, hour counters increment	kWh, kVArh and hour counters reset to zero
4	Hour counter increment	no increment
5	Hour counter increment	Hour counter reset to zero
6	kWh and kVArh counters reset to zero	-
7	Hour counter reset to zero	-
8	kWh, kVArh and hour counters reset to zero	-
9	Reset alarms	-
10	Turn displays OFF	-
11	-	-

## 4.16 CONFIGURING THE RELAY OUTPUT

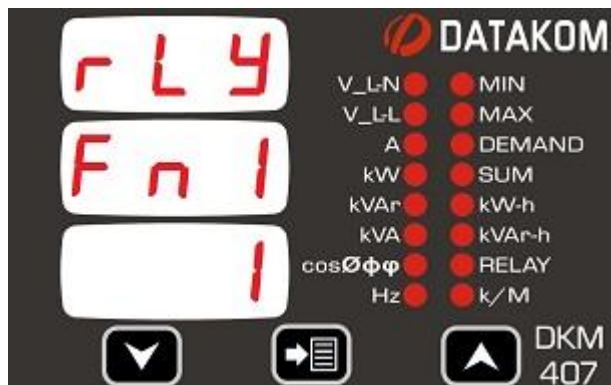

The relay output is a combination of 4 different input functions. The combination logic is explained in the next picture.

Each of 4 available functions is selected from the below list. Unused functions should be left as 0.

Value	Relay Function
0	-
1	Follows the digital input
2	kWh pulse output
3	kVAh pulse output
4	High voltage alarm
5	Low voltage alarm
6	High frequency alarm
7	Low frequency alarm
8	Overcurrent alarm
9	Excess active power alarm
10	Low active power alarm
11	Excess reactive power alarm
12	Low reactive power alarm
13	High $\cos\phi$ alarm
14	Low $\cos\phi$ alarm
15	Phase sequence alarm
16	Relay active if any alarm exists
17	Function active if a non-zero value is written to the Modbus register 31.

The factory set value for relay function 1 is 1. For relay functions 2-3-4 it is 0.

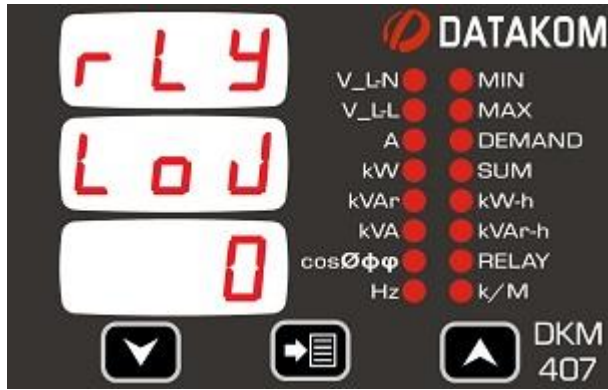

The relay output is the combination of 4 functions defined above. Thus various combined functions may be attributed to the relay output.

This parameter defines how functions are combined in order to generate the relay output.

**0:** Functions logically OR'ed. The relay output is active if any of the 4 functions is active.

**1:** Functions loagically AND'ed. The relay output is active if all 4 functions are active.

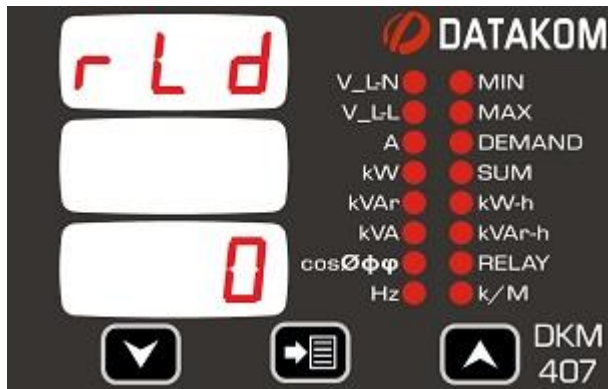

This parameter defines the delay between all conditions are met and the relay operates. (in seconds)

Factory set value is 0.

Adjustment range is 0 to 9999 sec.

## 4.17 ALARM DELAY

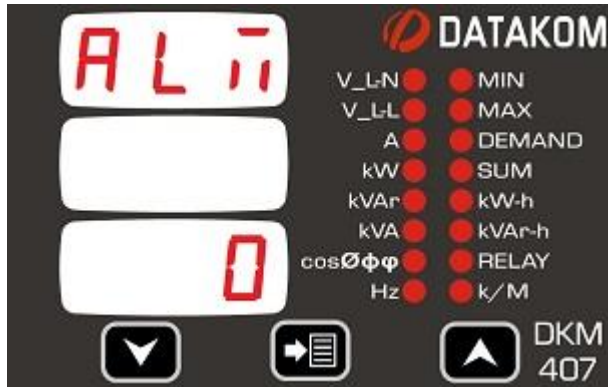

This parameter defines the delay between an alarm condition occurs and the device gives the alarm. It defines also the delay between an alarm condition is removed and the alarm goes off.

Factory set value is 0.

Adjustment range is 0 to 9999 sec.



## 4.18 MODBUS PARAMETERS

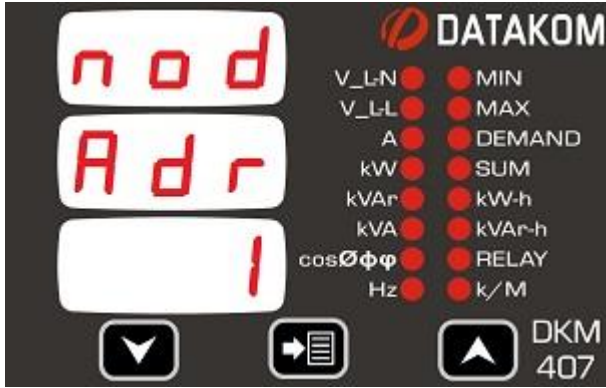

This is the Modbus node address of the device. Each device in a Modbus network must have a different node address.

Factory set value is 0.

Adjustment range is 0 to 255.

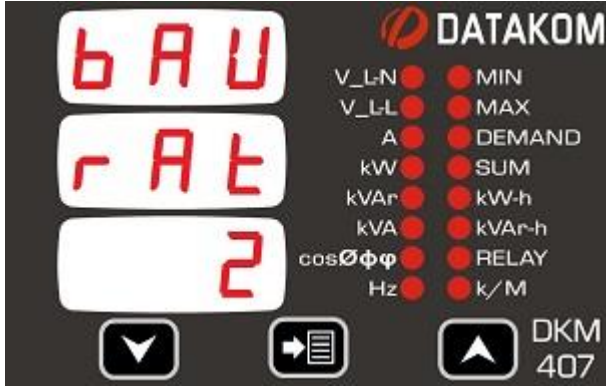

This parameter defines the bit rate used in Modbus communication.

**0:** Baud rate = 2400

**1:** Baud rate = 4800

**2:** Baud rate = 9600

**3:** Baud rate = 19200

**4:** Baud rate = 38400

**5:** Baud rate = 57600

**6:** Baud rate = 115200

Factory set value is 2.

Adjustment range is 0 to 6.



## 4.19 ENERGY PULSE OUTPUT (kWh, kVArh) PARAMETERS

If any of the 4 relay functions explained in chapter 4.16 is set to 2 (kWh pulse) or 3 (kVArh pulse) then the relay output will provide energy increment pulses conformally to below settings. When pulse output is set, other 3 relay functions are "don't care". The relay will function as a pulse output. kWh pulse output has priority. Thus if the output is set for both kWh and kVArh then it will function as kWh.

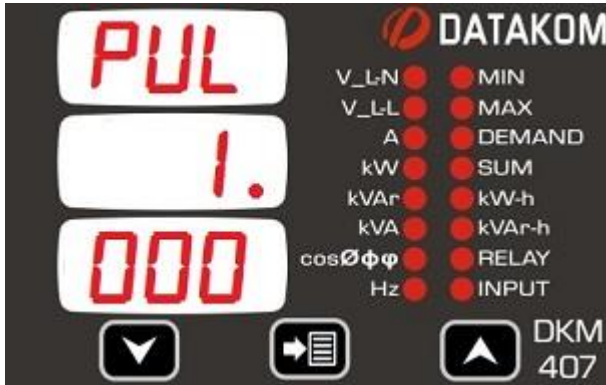

This parameter determines the amount of kWh (or kVArh) for 1 pulse output.

The factory set value is 1.000 kW per pulse.

The adjustment range is from 0.001 to 10.000 kW (or kVArh)

Standart fabrika çıkış değeri 1.000 kWh veya kVArh'dır.

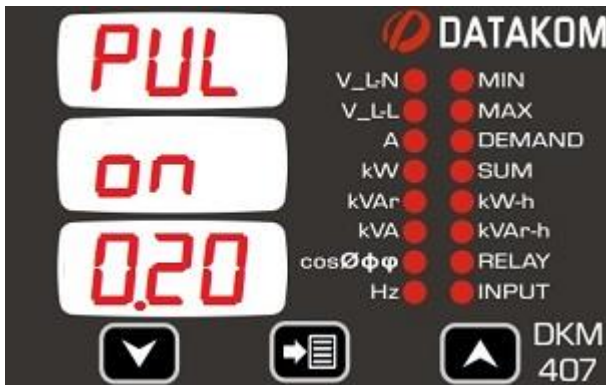

This parameter determines the pulse active period.

The factory set value is 0.20 sec (200 milisecond).

Adjustment range is 0.01sec to 9.99 sec.

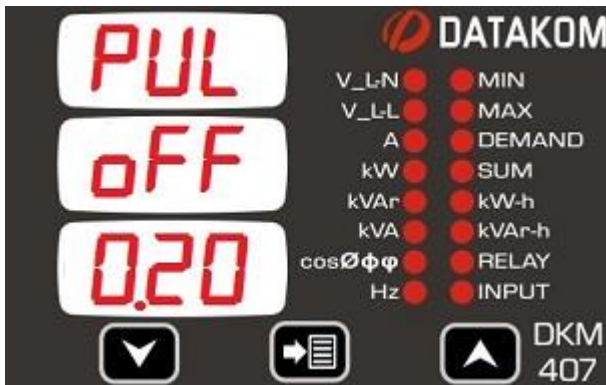

This parameter determines the minimum rest duration between two pulses.

The factory set value is 0.20 sec (200 milisecond).

Adjustment range is 0.01sec to 9.99 sec.

## 4.20 DISPLAYING THE FIRMWARE VERSION

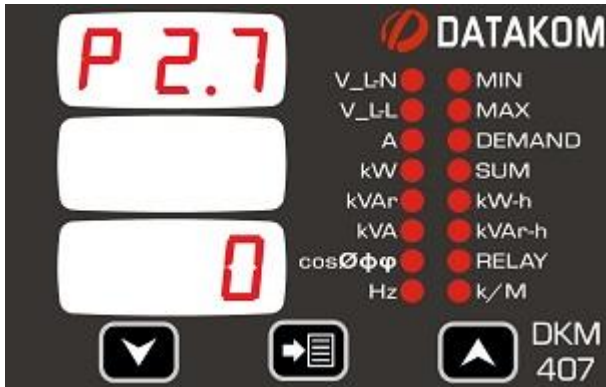

The device firmware version is displayed as shown in the lefthand figure.

P2.7 indicates that the firmware version is 2.7.

The firmware version will be required by the manufacturer together with any technical support request.

## 4.21 CALIBRATION

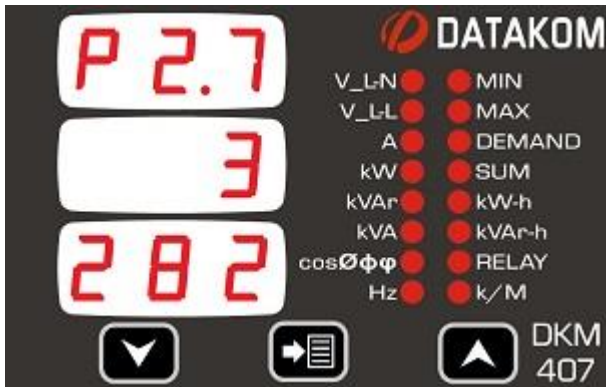

The unit is factory calibrated before shipment.

If recalibration is required, Please enter "3282" at the bottom display then press

 button.

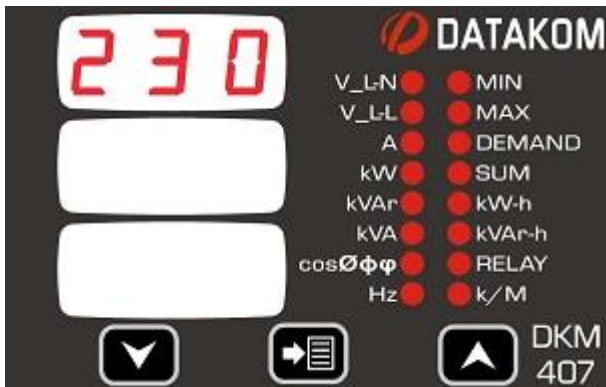

The calibration screen for L1 phase voltage will appear. 1 second after, the coefficient used for measuring the voltage will appear in displays 2 and 3.



Pressing   buttons will increase/decrease the measured value.

When the measured value is correct press  button. The next input will come to display.

Repeat above procedure for each input to be recalibrated.

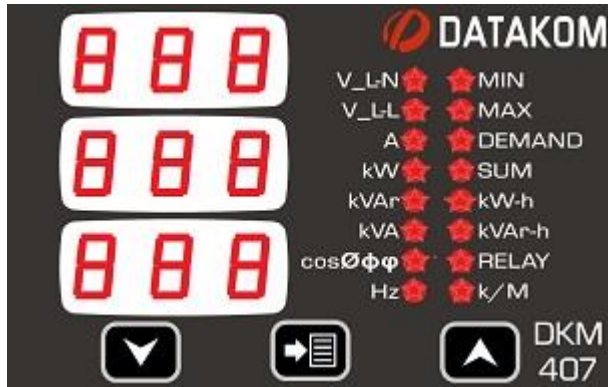
## 4.22 LAMP TEST



When all required parameters are programmed hold pressed together both   buttons for 2 seconds.

This will exit the configuration menu and perform a display test.

Check that all displays and leds are turned on.

Press any button to exit LAMP TEST and return to normal operating mode.

## 5. MODBUS COMMUNICATIONS

### 5.1. DESCRIPTION

The unit offers serial data communication port allowing it to be integrated in automation systems.

The serial port is of RS-485 MODBUS-RTU standard. It is fully isolated from power supply and measurement terminals for failure-free operation under harsh industrial conditions.

**The MODBUS properties of the unit are:**

- Data transfer mode: RTU
- Serial data: 1200-115200 bps adjustable, 8 bit data, no parity, 1 bit stop
- Supported functions:
  - Function 3 (Read multiple registers)
  - Function 6 (Write single register)
  - Function 10h (Write multiple registers)
- The answer to an incoming message is sent with a minimum of 4.3ms delay after message reception.

Each register consists of 2 bytes (16 bits). Larger data structures contain multiple registers.

Detailed description about the MODBUS protocol is found in the document “**Modicon Modbus Protocol Reference Guide**”. This document may be downloaded at:

<http://www.modbus.org/specs.php>

#### **Data Reading**

The function 03 (read multiple registers) will be used for data reading. The MODBUS master will send a query. The answer will be one of the below:

- A response containing the requested data
- An exceptional response indicating a read error.

The maximum number of registers read in one message is 123. If more registers are requested, the unit will send only the first 123 registers.

The query message specifies the starting register and quantity of registers to be read. The message structure is below:

Byte	Description	Value
0	Controller address	1 to 254
1	Function code	3
2	Starting address high	See below the description of available registers
3	Starting address low	
4	Number of registers high	always 0
5	Number of registers low	max 7Bh (123 decimal)
6	CRC low byte	See below for the checksum calculation
7	CRC high byte	

Here is the sequence to read 16 registers starting from address 20h (32 decimal):  
01 03 00 20 00 10 45 CC (each byte is expressed as 2 hexadecimal characters)

The checksum value in the above message may be used for the verification of checksum calculation algorithm.

The normal response will be:

Byte	Description	Value
0	Controller address	same as in the query
1	Function code	3
2	Data length in <b>bytes (L)</b>	number of registers * 2
3	High byte of 1st register	
4	Low byte of 1st register	
5	High byte of 2nd register	
6	Low byte of 2nd register	
....		
L+1	High byte of the last register	
L+2	Low byte of the last register	
L+3	CRC low byte	See below for the checksum calculation
L+4	CRC high byte	

The exceptional response will be:

Byte	Description	Value
0	Controller address	same as in the query
1	Function code	131 (function code + 128)
2	Exception code	2 (illegal address)
3	CRC low byte	See below for the checksum calculation
4	CRC high byte	

## **Data Writing**

The function 06 (write single register) function 10h (write multiple registers) are used for data writing. A maximum of 32 registers can be written at a time.

The MODBUS master will send a query containing data to be written. The answer will be one of the below:

- A normal response confirming successful write,
- An exceptional response indicating a write error.

Only some of the available registers are authorized to be written. An attempt to write a write protected register will result to the exceptional response.

The query message specifies the register address and data. The message structure is below:

Byte	Description	Value
0	Controller address	1 to 254
1	Function code	6
2	Register address high	See below the description of available registers
3	Register address low	
4	Data high byte	
5	Data low byte	
6	CRC low byte	See below for the checksum calculation
7	CRC high byte	

Here is the sequence to write the value 0010h to the register 40h (64 decimal):  
01 06 00 40 00 10 89 D2 (each byte is expressed as 2 hexadecimal characters)

The checksum value in the above message may be used for the verification of checksum calculation algorithm

The normal response will be the same as the query:

Byte	Description	Value
0	Controller address	1 to 253
1	Function code	6
2	Register address high	See below the description of available registers
3	Register address low	
4	Data high byte	
5	Data low byte	
6	CRC low byte	See below for the checksum calculation
7	CRC high byte	

The exceptional response will be:

Byte	Description	Value
0	Controller address	same as in the query
1	Function code	134 (function code + 128)
2	Exception code	2 (illegal address) or 10 (write protection)
3	CRC low byte	See below for the checksum calculation
4	CRC high byte	

## CRC calculation

Here is a procedure for generating a CRC:

- 1) Load a 16-bit register with FFFF hex (all 1's). Call this the CRC register.
- 2) Exclusive OR the first 8-bit byte of the message (the function code byte) with the low-order byte of the 16-bit CRC register, putting the result in the CRC register.
- 3) Shift the CRC register one bit to the right (toward the LSB), zero-filling the MSB. Extract and examine the LSB. The LSB is the least significant bit of the CRC **before** the shift operation.
- 4) If the LSB is 1: Exclusive OR the CRC register with the polynomial value A001 hex.
- 5) Repeat Steps 3 and 4 until 8 shifts have been performed. Thus, a complete 8-bit byte will be processed.
- 6) Repeat Steps 2 through 5 for the next 8-bit byte of the message. Continue doing this until all bytes have been processed.
- 7) The final contents of the CRC register is the CRC value.
- 8) Place the CRC into the message such that the low byte is transmitted first. The algorithm should give the correct CRC for below messages:

```
01 03 00 20 00 10 45 CC
01 06 00 40 00 10 89 D2
```

## **Error codes**

Only 3 error codes are used:

01: illegal function code

02: illegal address

10: write protection (attempt to write a read\_only register)

## **Data types**

Each register consists of 16 bits (2 bytes)

If the data type is a byte, only the low byte will contain valid data. High byte is don't care.

For data type longer than 16 bits, consecutive registers are used. The least significant register comes first.

## **5.2. COMMANDS**

Commands to the device are given by writing to below addresses.

If the value of "3282" is written to the address 16384, then below commands will be accepted during 10 minutes.

Other commands do not require a password to be written.

ADDRESS	NAME	DESCRIPTION	LENGTH	RD/ WR	DATA TYPE	COEF
16384	Password	Programming password	16 BIT	W-O	unsigned word	1
16385	Demand reset	Reset all demand registers	16 BIT	W-O	unsigned word	1
16386	Counter reset	Reset all energy counters (kWh-kVArh)	16 BIT	W-O	unsigned word	1
16387	Hours reset	Reset hours counter	16 BIT	W-O	unsigned word	1
16388	Alarm reset	Reset all alarms	16 BIT	W-O	unsigned word	1
16389	Factory reset	Return to factory set values	16 BIT	W-O	unsigned word	1



### 5.3. PROGRAM PARAMETERS

ADDRESS	NAME	DESCRIPTION	LENGTH	RD/ WR	DATA TYPE	COEF
01	Default screen	See chapter 4.6.	16 BIT	R/W	unsigned word	1
02	CT ratio	See chapter 4.7.	16 BIT	R/W	unsigned word	1
03	VT ratio	See chapter 4.8.	16 BIT	R/W	unsigned word	1
04	High voltage limit	See chapter 4.9.	16 BIT	R/W	unsigned word	1
05	Low voltage limit	See chapter 4.9.	16 BIT	R/W	unsigned word	1
06	High freq. limit	See chapter 4.10.	16 BIT	R/W	unsigned word	1
07	Low freq. limit	See chapter 4.10.	16 BIT	R/W	unsigned word	1
08	Overcurrent limit	See chapter 4.11.	16 BIT	R/W	unsigned word	1
09	High kW limit	See chapter 4.12.	16 BIT	R/W	unsigned word	1
10	Low kW limit	See chapter 4.12.	16 BIT	R/W	unsigned word	1
11	High kVAr limit	See chapter 4.13.	16 BIT	R/W	unsigned word	1
12	Low kVAr limit	See chapter 4.13.	16 BIT	R/W	unsigned word	1
13	High cos limit	See chapter 4.14.	16 BIT	R/W	unsigned word	1
14	Low cos limit	See chapter 4.14.	16 BIT	R/W	unsigned word	1
15	Digital input type	See chapter 4.15.	16 BIT	R/W	unsigned word	1
16	Digital input detection delay	See chapter 4.15.	16 BIT	R/W	unsigned word	1
17	Digital input function	See chapter 4.15.	16 BIT	R/W	unsigned word	1
18	Relay function 1	See chapter 4.16.	16 BIT	R/W	unsigned word	1
19	Relay function 2	See chapter 4.16.	16 BIT	R/W	unsigned word	1
20	Relay function 3	See chapter 4.16.	16 BIT	R/W	unsigned word	1
21	Relay function 4	See chapter 4.16.	16 BIT	R/W	unsigned word	1
22	Relay logic	See chapter 4.16.	16 BIT	R/W	unsigned word	1
23	Relay delay	See chapter 4.16.	16 BIT	R/W	unsigned word	1
24	Alarm delay	See chapter 4.17.	16 BIT	R/W	unsigned word	1
25	-	-	16 BIT	-	-	-
26	Modbus node address	See chapter 4.18.	16 BIT	R/W	unsigned word	1
27	Modbus baud rate	See chapter 4.18.	16 BIT	R/W	unsigned word	1
28	Amount of kWh (or kVArh) per pulse	Explained in chapter 4.19.	16 BIT	R/W	unsigned word	0.001
29	Active pulse duration (second)	Explained in chapter 4.19.	16 BIT	R/W	unsigned word	0.01
30	Rest between pulses	Explained in chapter 4.19.	16 BIT	R/W	unsigned word	0.01
31	Relay control through Modbus	If relay function is selected as 17 (see chapter 4.16) then if a value other than zero is written to this address then the relay will operate.	16 BIT	R/W	unsigned word	1



## 5.4. MEASUREMENTS AND CONTROLLER RECORDS

ADRESS	NAME	DESCRIPTION	LENGTH	RD/ WR	DATA TYPE	COEF
20480	Phase L1 voltage		32 BIT	R-O	unsigned long	1
20482	Phase L2 voltage		32 BIT	R-O	unsigned long	1
20484	Phase L3 voltage		32 BIT	R-O	unsigned long	1
20486	Phase L1-L2 voltage		32 BIT	R-O	unsigned long	1
20488	Phase L2-L3 voltage		32 BIT	R-O	unsigned long	1
20490	Phase L3-L1 voltage		32 BIT	R-O	unsigned long	1
20492	Phase L1 current		32 BIT	R-O	unsigned long	0.1
20494	Phase L2 current		32 BIT	R-O	unsigned long	0.1
20496	Phase L3 current		32 BIT	R-O	unsigned long	0.1
20498	Neutral current	RMS value of the neutral current	32 BIT	R-O	unsigned long	0.1
20500	Phase L1 active power		32 BIT	R-O	unsigned long	0.1
20502	Phase L2 active power		32 BIT	R-O	unsigned long	0.1
20504	Phase L3 active power		32 BIT	R-O	unsigned long	0.1
20506	Total active power		32 BIT	R-O	unsigned long	0.1
20508	Phase L1 reactive power		32 BIT	R-O	unsigned long	0.1
20510	Phase L2 reactive power		32 BIT	R-O	unsigned long	0.1
20512	Phase L3 reactive power		32 BIT	R-O	unsigned long	0.1
20514	Total reactive power		32 BIT	R-O	unsigned long	0.1
20516	Phase L1 apparent power		32 BIT	R-O	unsigned long	0.1
20518	Phase L2 apparent power		32 BIT	R-O	unsigned long	0.1
20520	Phase L3 apparent power		32 BIT	R-O	unsigned long	0.1
20522	Total apparent power		32 BIT	R-O	unsigned long	0.1
20524	Phase L1 power factor		16 BIT	R-O	unsigned word	0.001
20525	Phase L2 power factor		16 BIT	R-O	unsigned word	0.001
20526	Phase L3 power factor		16 BIT	R-O	unsigned word	0.001
20527	Total power factor		16 BIT	R-O	unsigned word	0.001
20528	Frequency		16 BIT	R-O	unsigned word	0.01
20529	Phase L1 voltage THD		16 BIT	R-O	unsigned word	1
20530	Phase L2 voltage THD		16 BIT	R-O	unsigned word	1
20531	Phase L3 voltage THD		16 BIT	R-O	unsigned word	1
20532	Phase L1-L2 voltage THD		16 BIT	R-O	unsigned word	1
20533	Phase L2-L3 voltage THD		16 BIT	R-O	unsigned word	1
20534	Phase L3-L1 voltage THD		16 BIT	R-O	unsigned word	1
20535	Phase L1 current THD		16 BIT	R-O	unsigned word	1
20536	Phase L2 current THD		16 BIT	R-O	unsigned word	1
20537	Phase L3 current THD		16 BIT	R-O	unsigned word	1
20538	Neutral current THD		16 BIT	R-O	unsigned word	1

ADRESS	NAME	DESCRIPTION	LENGTH	RD/ WR	DATA TYPE	COEF
20540	Phase L1 voltage MIN		32 BIT	R-O	signed long	1
20542	Phase L2 voltage MIN		32 BIT	R-O	signed long	1
20544	Phase L3 voltage MIN		32 BIT	R-O	signed long	1
20546	Phase L1-L2 voltage MIN		32 BIT	R-O	signed long	1
20548	Phase L2-L3 voltage MIN		32 BIT	R-O	signed long	1
20550	Phase L3-L1 voltage MIN		32 BIT	R-O	signed long	1
20552	Phase L1 current MIN		32 BIT	R-O	signed long	0.1
20554	Phase L2 current MIN		32 BIT	R-O	signed long	0.1
20556	Phase L3 current MIN		32 BIT	R-O	signed long	0.1
20558	Neutral current MIN		32 BIT	R-O	signed long	0.1
20560	Phase L1 active power MIN		32 BIT	R-O	signed long	0.1
20562	Phase L2 active power MIN		32 BIT	R-O	signed long	0.1
20564	Phase L3 active power MIN		32 BIT	R-O	signed long	0.1
20566	Total active power MIN		32 BIT	R-O	signed long	0.1
20568	Phase L1 reactive power MIN		32 BIT	R-O	signed long	0.1
20570	Phase L2 reactive power MIN		32 BIT	R-O	signed long	0.1
20572	Phase L3 reactive power MIN		32 BIT	R-O	signed long	0.1
20574	Total reactive power MIN		32 BIT	R-O	signed long	0.1
20576	Phase L1 apparent power MIN		32 BIT	R-O	signed long	0.1
20578	Phase L2 apparent power MIN		32 BIT	R-O	signed long	0.1
20580	Phase L3 apparent power MIN		32 BIT	R-O	signed long	0.1
20582	Total apparent power MIN		32 BIT	R-O	signed long	0.1
20584	Phase L1 power factor MIN		32 BIT	R-O	signed long	0.001
20586	Phase L2 power factor MIN		32 BIT	R-O	signed long	0.001
20588	Phase L3 power factor MIN		32 BIT	R-O	signed long	0.001
20590	Total power factor MIN		32 BIT	R-O	signed long	0.001
20592	Frequency MIN		32 BIT	R-O	signed long	0.01

ADRESS	NAME	DESCRIPTION	LENGTH	RD/ WR	DATA TYPE	COEF
20594	Phase L1 voltage MAX		32 BIT	R-O	signed long	1
20596	Phase L2 voltage MAX		32 BIT	R-O	signed long	1
20598	Phase L3 voltage MAX		32 BIT	R-O	signed long	1
20600	Phase L1-L2 voltage MAX		32 BIT	R-O	signed long	1
20602	Phase L2-L3 voltage MAX		32 BIT	R-O	signed long	1
20604	Phase L3-L1 voltage MAX		32 BIT	R-O	signed long	1
20606	Phase L1 current MAX		32 BIT	R-O	signed long	0.1
20608	Phase L2 current MAX		32 BIT	R-O	signed long	0.1
20610	Phase L3 current MAX		32 BIT	R-O	signed long	0.1
20612	Neutral current MAX		32 BIT	R-O	signed long	0.1
20614	Phase L1 active power MAX		32 BIT	R-O	signed long	0.1
20616	Phase L2 active power MAX		32 BIT	R-O	signed long	0.1
20618	Phase L3 active power MAX		32 BIT	R-O	signed long	0.1
20620	Total active power MAX		32 BIT	R-O	signed long	0.1
20622	Phase L1 reactive power MAX		32 BIT	R-O	signed long	0.1
20624	Phase L2 reactive power MAX		32 BIT	R-O	signed long	0.1
20626	Phase L3 reactive power MAX		32 BIT	R-O	signed long	0.1
20628	Total reactive power MAX		32 BIT	R-O	signed long	0.1
20630	Phase L1 apparent power MAX		32 BIT	R-O	signed long	0.1
20632	Phase L2 apparent power MAX		32 BIT	R-O	signed long	0.1
20634	Phase L3 apparent power MAX		32 BIT	R-O	signed long	0.1
20636	Total apparent power MAX		32 BIT	R-O	signed long	0.1
20638	Phase L1 power factor MAX		32 BIT	R-O	signed long	0.001
20640	Phase L2 power factor MAX		32 BIT	R-O	signed long	0.001
20642	Phase L3 power factor MAX		32 BIT	R-O	signed long	0.001
20644	Total power factor MAX		32 BIT	R-O	signed long	0.001
20646	Frequency MAX		32 BIT	R-O	signed long	0.01
20648	kWh counter		32 BIT	R-O	unsigned long	0.1
20650	kVArh counter		32 BIT	R-O	unsigned long	0.1
20652	Total run hour counter		32 BIT	R-O	unsigned long	0.1
20654	LEDs	LED status	16 BIT	R-O	unsigned word	1
20655	Buttons	Buton status	16 BIT	R-O	unsigned word	1
20656	Alarms	Alarm status	16 BIT	R-O	unsigned word	1
20657	Relay Status	Relay is ON if value is not zero	16 BIT	R-O	unsigned word	1
20658	Voltage Demand		32 BIT	R-O	signed long	1
20660	Current Demand		32 BIT	R-O	signed long	0.1
20662	Active Power Demand		32 BIT	R-O	signed long	0.1

LED status register is 16 bits long. Each bit shows the status of one led.

<b>BIT NO:</b>	<b>DESCRIPTION</b>
0	k/M (Kilo/Mega)
1	Relay
2	Frequency (Hz)
3	Total (Sum)
4	Demand
5	MAX
6	MIN
7	kVArh
8	kWh
9	cos
10	kVA
11	kVAr
12	kW
13	Amperes (A)
14	Phase-Phase Voltages (VLL)
15	Phase-Neutral Voltages (VLN)

Button status register is 16 bits long. Each bit shows the status of one button.

<b>BIT NO:</b>	<b>DESCRIPTION</b>
0	Set (Menu) button pressed
1	Set (Menu) button long pressed
2	Set (Menu) button very long pressed
3	Up Arrow button pressed
4	Up Arrow button long pressed
5	Up Arrow button very long pressed
6	Down Arrow button pressed
7	Down Arrow button long pressed
8	Down Arrow button very long pressed
9	Digital Input Status (1:N.O. 0:N.C.)
10	-
11	-
12	-
13	-
14	-
15	-

Alarm status register is 16 bit long. Each bit shows the status of an alarm.

<b>BIT NO:</b>	<b>DESCRIPTION</b>
0	-
1	-
2	-
3	-
4	High voltage
5	Low voltage
6	High Frequency
7	Low Frequency
8	High current
9	High kW
10	Low kW
11	High kVAr
12	Low kVAr
13	High power factor (cos)
14	Low power factor (cos)
15	Phase sequence failure

## 6. TECHNICAL SPECIFICATIONS

**Supply voltage:** 85-305 V AC (L1-NEUTRAL)

**Supply frequency:** 45-65Hz

**Measurement inputs:**

**Voltage:** 10 - 305 V AC (P-N)  
20 - 530 V AC (P-P)

**Current:** 0.2 - 6.00 A AC

**Frequency:** 30 - 100 Hz

**Accuracy:**

**Voltage:** % 0.5 + 1 digit

**Current:** % 0.5 + 1 digit

**Frequency:** % 0.5 + 1 digit

**Power (kW,kVAr):** %1.0 + 2 digit

**Cos:** %2.0 + 2 digit

**Measurement range:**

**CT range:** 5/5A to 5000/5A

**VT range:** 0.1/1 to 200.0/1

**kW range:** 0.1 kW to 6.5 MW

**Power consumption:** < 4 VA

**Loading:**

**Voltage inputs:** < 0.1VA per phase

**Current inputs:** < 1VA per phase

**Relay output:** 5A @ 250V AC

**Digital input:**

**Active level:** 5 - 30V DC or AC

**Min pulse:** 250ms.

**Isolation:** 1000V AC, 1 minute

**Operating temp. range:** -20°C to +70 °C  
-4 °F to 158°F

**Max. Relative humidity:** 95% non condensing

**Enclosure:** Flame retardant, ROHS compliant, high temperature ABS/PC (UL94-V0)

**Installation:** DIN rail mounted

**Dimensions:** 70x115x66mm (WxHxD)

**Weight:** 200 g (approximative)

**EU Directives:**

2006/95/EC (LVD)

2004/108/EC

(EMC)

**Reference**

**standards:**

EN 61010 (safety)

EN 61326 (EMC)