



# D-500L

## ADVANCED GENSET CONTROLLER

### DESCRIPTION

The D-xxx series are next generation genset control units combining multi-functionality and wide communication possibilities together with a reliable and low cost design.

The unit complies and mostly exceeds world's tightest safety, EMC, vibration and environmental standards for the industrial category.

Software features are complete with easy firmware upgrade process through USB port.

The Windows based PC software allows monitoring and programming through USB, serial and GPRS.

The PC based Rainbow Scada software allows monitoring and control of an unlimited number of gensets from a single central location.

### FUNCTIONALITIES

*AMF unit with uninterrupted transfer*  
*ATS unit with uninterrupted transfer*  
*Remote start controller*  
*Manual start controller*  
*Engine controller*  
*Remote display & control unit*  
*Waveform display of V & I*  
*Harmonic analysis of V & I*  
*CTs at genset or load side*

### COMMUNICATIONS

**GSM-GPRS**  
 Internal GPRS modem (optional)  
**GSM-SMS**  
 e-mail  
 Modbus  
 USB Device  
 RS-485  
 RS-232  
 J1939-CANBUS

### TOPOLOGIES

*3 phases 4 wires, star*  
*3 phases 3 wires, 3 CTs*  
*3 phases 3 wires, 2 CTs (L1-L2)*  
*3 phases 3 wires, 2 CTs (L1-L3)*  
*2 phases 3 wires, L1-L2*  
*2 phases 3 wires, L1-L3*  
*3 phases 4 wires, delta*  
*1 phase 2 wires*



## COPYRIGHT NOTICE

Any unauthorized use or copying of the contents or any part of this document is prohibited. This applies in particular to trademarks, model denominations, part numbers and drawings.

## ABOUT THIS DOCUMENT

This document describes minimum requirements and necessary steps for the successful installation of the D-xxx family units.

Follow carefully advices given in the document. These are often good practices for the installation of genset control units which reduce future issues.

For all technical queries please contact Datakom at below e-mail address:

**datakom@datakom.com.tr**

## QUERRIES

If additional information to this manual is required, please contact the manufacturer directly at below e-mail address:

**datakom@datakom.com.tr**

Please provide following information in order to get answers to any question:

- Device model name (see the back panel of the unit),
- Complete serial number (see the back panel of the unit),
- Firmware version (read from the display screen),
- Measuring-circuit voltage and power supply voltage,
- Precise description of the query.

## RELATED DOCUMENTS

FILENAME	DESCRIPTION
500-Rainbow Installation	Rainbow Plus D-500 D-700 Installation Guide
500-Rainbow Usage	Rainbow Plus D-500 D-700 Usage Guide
500-GSM Configuration	GSM Configuration Guide for D-500 D-700
500-Firmware Update	Firmware Update Guide for D-500 D-700
500-MODBUS	Modbus Application Manual for D-500 D-700
500-Rainbow Scada Installation	Rainbow Scada Installation Guide
500-Rainbow Scada Usage	Rainbow Scada Usage Guide

## REVISION HISTORY

REVISION	DATE	AUTHOR	DESCRIPTION
01	19.06.2015	MH	First edition, firmware version 5.4
02	06.05.2016	MH	Revised for firmware version 5.7

## TERMINOLOGY



**CAUTION:** Potential risk of injury or death.



**WARNING:** Potential risk of malfunction or material damage.



**ATTENTION:** Useful hints for the understanding of device operation.

## ORDERING CODES

The D-500 family units are available in various options and peripheral features. Please use below information for ordering the correct version:

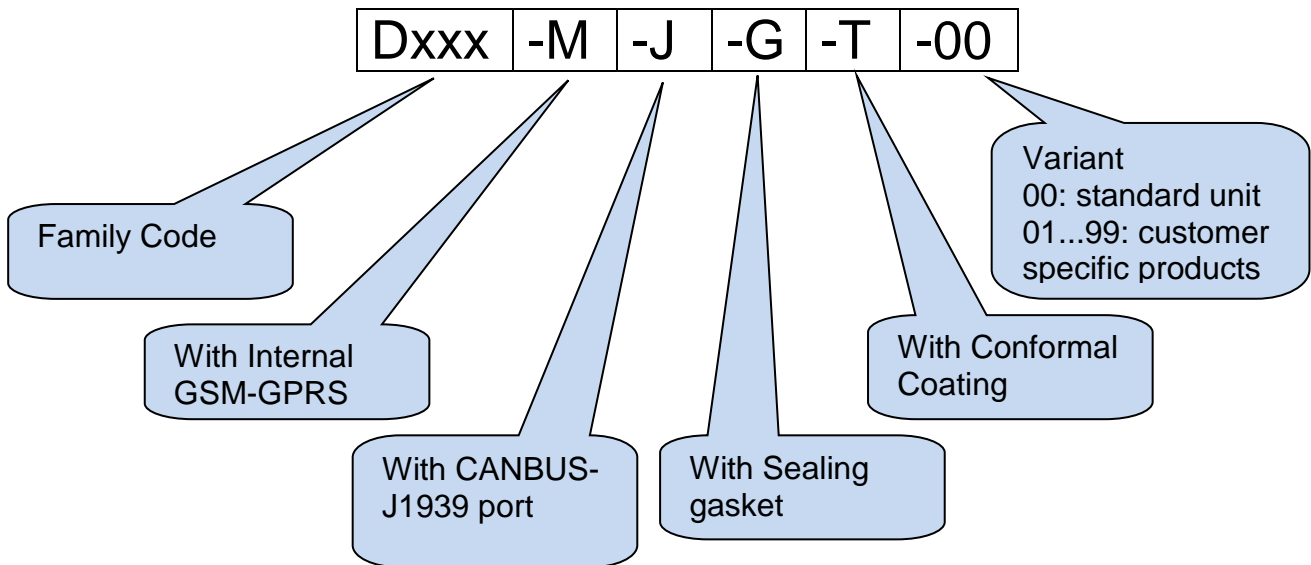

## SPARE PARTS



Screw type bracket  
Stock Code=J10P01 (per unit)



Self Retaining type bracket  
Stock Code=K16P01 (per unit)



Sealing Gasket



### SAFETY NOTICE

Failure to follow below instructions will result in death or serious injury



- Electrical equipment should be installed only by qualified specialist. No responsibility is assured by the manufacturer or any of its subsidiaries for any consequences resulting from the non-compliance to these instructions.



- Check the unit for cracks and damages due to transportation. Do not install damaged equipment.



- Do not open the unit. There are no serviceable parts inside.
- Fuses must be connected to the power supply and phase voltage inputs, in close proximity of the unit.
- Fuses must be of fast type (FF) with a maximum rating of 6A.



- Disconnect all power before working on equipment.



- When the unit is connected to the network do not touch terminals.



- Short circuit terminals of unused current transformers.



- Any electrical parameter applied to the device must be in the range specified in the user manual. Although the unit is designed with a wide safety margin, over-range parameters may reduce lifetime, alter operational precision or even damage the unit.

- Do not try to clean the device with solvent or the like. Only clean with a damp cloth.

- Verify correct terminal connections before applying power.

- Only for front panel mounting.



Current Transformers must be used for current measurement.  
No direct connection allowed.

---

## TABLE OF CONTENTS

- 1. INSTALLATION INSTRUCTIONS**
- 2. MOUNTING**
  - 2.1 DIMENSIONS
  - 2.2 SEALING, GASKET
  - 2.3 ELECTRICAL INSTALLATION
- 3. TERMINAL DESCRIPTIONS**
  - 3.1. BATTERY VOLTAGE INPUT
  - 3.2. AC VOLTAGE INPUTS
  - 3.3. AC CURRENT INPUTS
  - 3.4. DIGITAL INPUTS
  - 3.5. ANALOG SENDER INPUTS AND SENDER GROUND
  - 3.6. CHARGE INPUT TERMINAL
  - 3.7. MAGNETIC PICKUP INPUT
  - 3.8. MAINS CONTACTOR OUTPUT
  - 3.9. GENERATOR CONTACTOR OUTPUT
  - 3.10. DIGITAL OUTPUTS
  - 3.11. INPUT/OUTPUT EXTENSION
  - 3.12. RS-485 PORT
  - 3.13. RS-232 PORT
  - 3.14. J1939-CANBUS PORT
  - 3.15. USB DEVICE PORT
  - 3.16. GSM MODEM (OPTIONAL)
- 4. TOPOLOGIES**
  - 4.1. SELECTING THE TOPOLOGY
  - 4.2. 3 PHASE, 4 WIRE, STAR
  - 4.3. 3 PHASE, 3 WIRE, DELTA
  - 4.4. 3 PHASE, 4 WIRE, DELTA
  - 4.5. 3 PHASE, 3 WIRE, DELTA, 2 CT (L1-L2)
  - 4.6. 3 PHASE, 3 WIRE, DELTA, 2 CT (L1-L3)
  - 4.7. 2 PHASE, 3 WIRE, DELTA, 2 CTs (L1-L2)
  - 4.8. 2 PHASE, 3 WIRE, DELTA, 2 CTs (L1-L3)
  - 4.9. 1 PHASE, 2 WIRE

## **5. FUNCTIONALITIES**

- 5.1. CT LOCATION SELECTION**
- 5.2. AMF FUNCTIONALITY**
- 5.3. ATS FUNCTIONALITY**
- 5.4. REMOTE START FUNCTIONALITY**
- 5.5. ENGINE CONTROLLER FUNCTIONALITY**
- 5.6. REMOTE DISPLAY UNIT FUNCTIONALITY**
- 5.7. 400HZ OPERATION**

## **6. CONNECTION DIAGRAMS**

- 6.1. AMF FUNCTIONALITY, CTs AT LOAD SIDE**
- 6.2. AMF FUNCTIONALITY, CTs AT ALTERNATOR SIDE**
- 6.3. ATS FUNCTIONALITY**
- 6.4. REMOTE START FUNCTIONALITY**
- 6.5. ENGINE CONTROL FUNCTIONALITY**
- 6.6. REMOTE DISPLAY PANEL FUNCTIONALITY**

## **7. TERMINAL DESCRIPTION**

## **8. TECHNICAL SPECIFICATIONS**

## **9. DESCRIPTION OF CONTROLS**

- 9.1. FRONT PANEL FUNCTIONALITY**
- 9.2. PUSHBUTTON FUNCTIONS**
- 9.3. DISPLAY SCREEN ORGANIZATION**
- 9.4. AUTOMATIC DISPLAY SCROLL**
- 9.5. MEASURED PARAMETERS**
- 9.6. LED LAMPS**

## **10. WAVEFORM DISPLAY & HARMONIC ANALYSIS**

## **11. DISPLAYING EVENT LOGS**

## **12. STATISTICAL COUNTERS**

- 12.1. FUEL FILLING COUNTER**
- 12.2. FUEL CONSUMPTION MONITORING**

## **13. OPERATION OF THE UNIT**

- 13.1. QUICK START GUIDE**
- 13.2. STOP MODE**
- 13.3. AUTO MODE**
- 13.4. RUN MODE, MANUAL CONTROL**
- 13.5. TEST MODE**

## **14. PROTECTIONS AND ALARMS**

- 14.1. DISABLING ALL PROTECTIONS**
- 14.2. SERVICE REQUEST ALARM**
- 14.3. SHUTDOWN ALARMS**
- 14.4. LOADDUMP ALARMS**

- 14.5. WARNINGS
- 14.6. NON-VISUAL WARNINGS
- 15. PROGRAMMING**
  - 15.1. RESETTING TO FACTORY DEFAULTS
  - 15.2. ENTERING THE PROGRAMMING MODE
  - 15.3. NAVIGATING BETWEEN MENUS
  - 15.4. MODIFYING PARAMETER VALUE
  - 15.5. PROGRAMMING MODE EXIT
- 16. PROGRAM PARAMETER LIST**
  - 16.1. CONTROLLER CONFIGURATION GROUP
  - 16.2. ELECTRICAL PARAMETERS GROUP
  - 16.3. ENGINE PARAMETERS GROUP
  - 16.4. ADJUST DATE AND TIME
  - 16.5. WEEKLY OPERATION SCHEDULE
  - 16.6. EXERCISER SCHEDULE
  - 16.7. SENDER CONFIGURATION
  - 16.8. DIGITAL INPUT CONFIGURATION
  - 16.9. OUTPUT CONFIGURATION
  - 16.10. SITE ID STRING
  - 16.11. ENGINE SERIAL NUMBER
  - 16.12. MODEM1-2/SMS1-2-3-4 TELEPHONE NUMBERS
  - 16.13. GSM MODEM PARAMETERS
  - 16.14. ETHERNET PARAMETERS
- 17. CRANK CUTTING**
- 18. OVERCURRENT PROTECTION (IDMT)**
- 19. MOTORIZED CIRCUIT BREAKER CONTROL**
- 20. J1939 CANBUS ENGINE SUPPORT**
- 21. GPS SUPPORT**
- 22. GSM CONFIGURATION**
- 23. CENTRAL MONITORING OF GENSETS**
- 24. E-MAIL SENDING**
- 25. SMS COMMANDS**



**26. SOFTWARE FEATURES**

- 26.1. LOAD SHEDDING / DUMMY LOAD
- 26.2. LOAD ADD / SUBSTRACT
- 26.3. FIVE STEP LOAD MANAGEMENT
- 26.4. REMOTE START OPERATION
- 26.5. DISABLE AUTO START, SIMULATE MAINS
- 26.6. BATTERY CHARGING OPERATION, DELAYED SIMULATE MAINS
- 26.7. DUAL GENSET MUTUAL STANDBY OPERATION
- 26.8. MULTIPLE VOLTAGE AND FREQUENCY
- 26.9. SINGLE PHASE OPERATION
- 26.10. EXTERNAL CONTROL OF THE UNIT
- 26.11. AUTOMATIC EXERCISER
- 26.12. WEEKLY OPERATION SCHEDULER
- 26.13. ENGINE HEATING OPERATION
- 26.14. ENGINE IDLE SPEED OPERATION
- 26.15. ENGINE BLOCK HEATER
- 26.16. FUEL PUMP CONTROL
- 26.17. GAS ENGINE FUEL SOLENOID CONTROL
- 26.18. PRE-TRANSFER SIGNAL
- 26.19. CHARGING THE ENGINE BATTERY
- 26.20. EXTERNALLY CONTROLLED DIGITAL OUTPUTS
- 26.21. COMBAT MODE
- 26.22. RESETTING THE CONTROLLER
- 26.23. AUTOMATIC CONNECTION TOPOLOGY DETERMINATION
- 26.24. ZERO POWER AT REST

**27. MODBUS COMMUNICATIONS**

- 27.1. PARAMETERS REQUIRED FOR RS-485 MODBUS OPERATION
- 27.2. DATA FORMATS

**28. DECLARATION OF CONFORMITY****29. MAINTENANCE****30. DISPOSAL OF THE UNIT****31. ROHS COMPLIANCE****32. TROUBLESHOOTING GUIDE**

## 1. INSTALLATION INSTRUCTIONS

### **Before installation:**

- Read the user manual carefully, determine the correct connection diagram.
- Remove all connectors and mounting brackets from the unit, then pass the unit through the mounting opening.
- Put mounting brackets and tighten. Do not tighten too much, this can brake the enclosure.
- Make electrical connections with plugs removed from sockets, then place plugs to their sockets.
- Be sure that adequate cooling is provided.
- Be sure that the temperature of the environment will not exceed the maximum operating temperature in any case.

### **Below conditions may damage the device:**

- Incorrect connections.
- Incorrect power supply voltage.
- Voltage at measuring terminals beyond specified range.
- Voltage applied to digital inputs over specified range.
- Current at measuring terminals beyond specified range.
- Overload or short circuit at relay outputs
- Connecting or removing data terminals when the unit is powered-up.
- High voltage applied to communication ports.
- Ground potential differences at non-isolated communication ports.
- Excessive vibration, direct installation on vibrating parts.



**Current Transformers must be used for current measurement.**

**No direct connection allowed.**

### **Below conditions may cause abnormal operation:**

- Power supply voltage below minimum acceptable level.
- Power supply frequency out of specified limits
- Phase order of voltage inputs not correct.
- Current transformers not matching related phases.
- Current transformer polarity incorrect.
- Missing grounding.

## 2. MOUNTING

### 2.1. DIMENSIONS

**Dimensions:** 200x148x47mm (7.9"x5.8"x1.9")  
**Panel Cutout:** 176x121mm minimum (7.0"x4.8")  
**Weight:** 450g (1 lb)

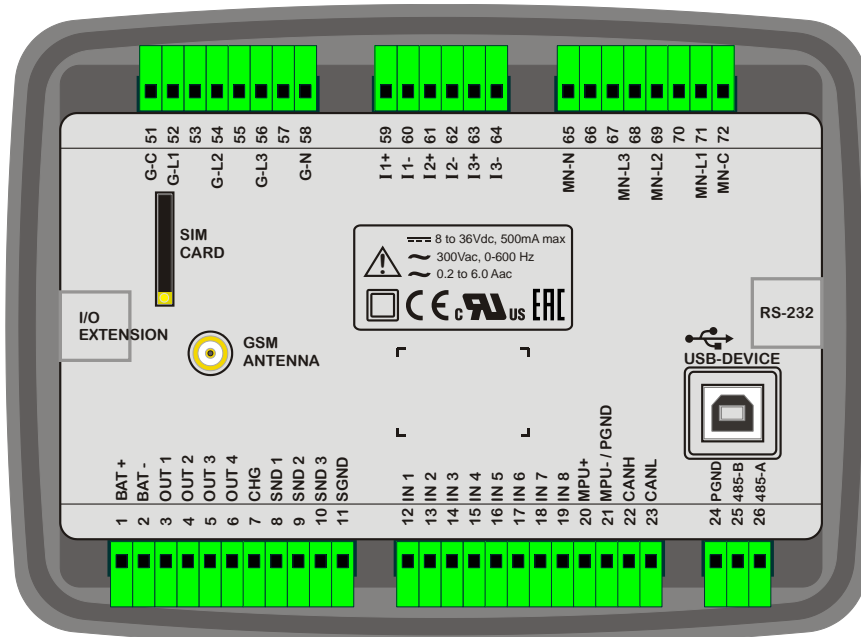



**The unit is designed for panel mounting. The user should not be able to access parts of the unit other than the front panel.**

Mount the unit on a flat, vertical surface. Before mounting, remove the mounting brackets and connectors from the unit, then pass the unit through the mounting opening.

Place and tighten mounting brackets.

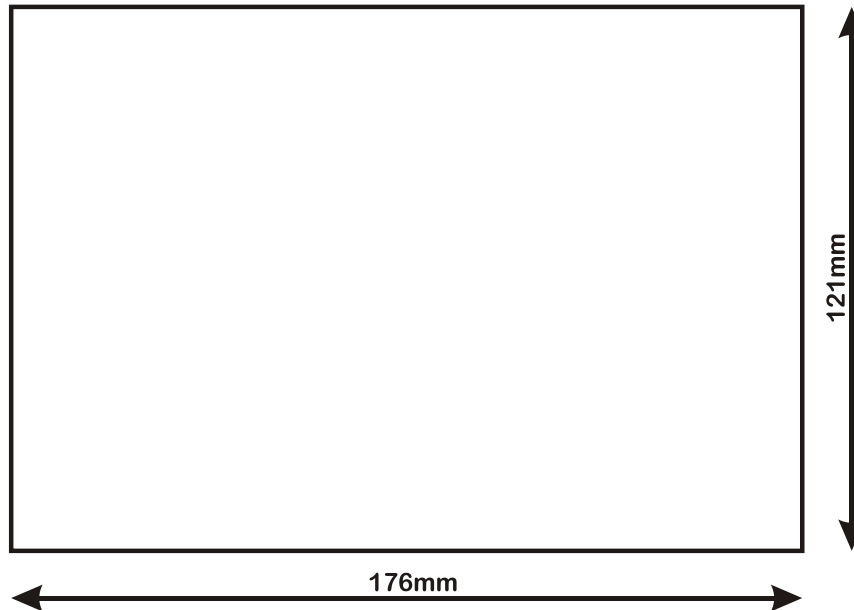

## Panel Cutout

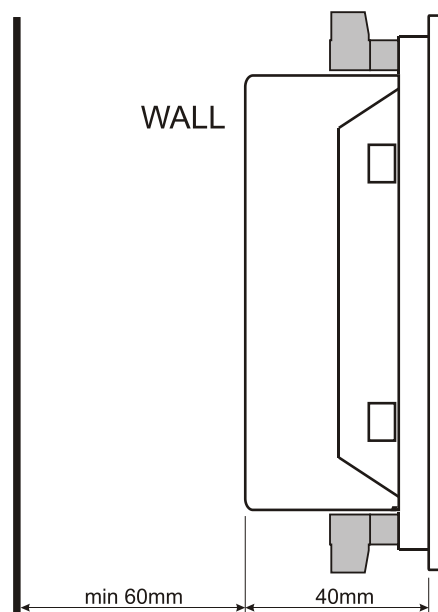

## Required Panel Depth

Two different types of brackets are provided:



Screw type bracket



Self retaining type bracket



Installation of screw type bracket



Installation of self retaining type bracket



**Do not tighten too much, this may break the unit.**

## 2.2. SEALING, GASKET

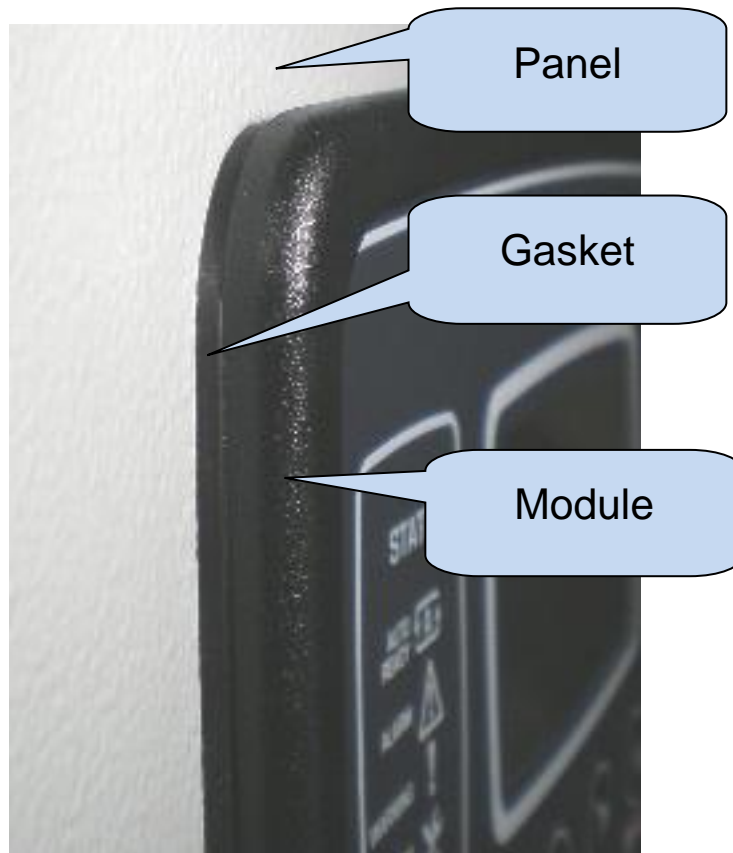

The rubber gasket provides a watertight means of mounting the module to the gasket panel. Together with the gasket, IEC 60529-IP65 protection can be reached from the front panel. A short definition of IP protection levels is given below.

### 1st Digit

0 Not protected

1 Protected against solid foreign objects of 50 mm diameter and greater

2 Protected against solid foreign objects of 12,5 mm diameter and greater

3 Protected against solid foreign objects of 2,5 mm diameter and greater

4 Protected against solid foreign objects of 1,0 mm diameter and greater

5 Protected from the amount of dust that would interfere with normal operation

**6 Dust tight**

### 2nd Digit

0 Not protected

1 Protected against vertically falling water drops

2 Protected against vertically falling water drops when enclosure is tilted up to 15 °

3 Protected against water sprayed at an angle up to 60 ° on either side of the vertical

4 Protected against water splashed against the component from any direction

**5 Protected against water projected in jets from any direction**

6 Protected against water projected in powerful jets from any direction

7 Protected against temporary immersion in water

8 Protected against continuous immersion in water, or as specified by the user

## 2.3. ELECTRICAL INSTALLATION



**Do not install the unit close to high electromagnetic noise emitting devices like contactors, high current busbars, switchmode power supplies and the like.**

Although the unit is protected against electromagnetic disturbance, excessive disturbance can affect the operation, measurement precision and data communication quality.

- **ALWAYS** remove plug connectors when inserting wires with a screwdriver.
- Fuses must be connected to the power supply and phase voltage inputs, in close proximity of the unit.
- Fuses must be of fast type (FF) with a maximum rating of 6A.
- Use cables of appropriate temperature range.
- Use adequate cable section, at least 0.75mm<sup>2</sup> (AWG18).
- Follow national rules for electrical installation.
- Current transformers must have 5A output.
- For current transformer inputs, use at least 1.5mm<sup>2</sup> section (AWG15) cable.
- The current transformer cable length should not exceed 1.5 meters. If longer cable is used, increase the cable section proportionally.



**Current Transformers must be used for current measurement.**

**No direct connection allowed.**



**The engine body must be grounded. Otherwise faulty voltage and frequency measurements may occur.**



**For the correct operation of the exerciser and weekly schedule programs, adjust the real time clock of the unit through programming menu.**

### 3. TERMINAL DESCRIPTIONS

#### 3.1. BATTERY VOLTAGE INPUT

<b>Supply voltage:</b>	8 to 36VDC
<b>Cranking dropouts:</b>	Survives 0VDC during 100ms. The voltage before surge should be 8VDC minimum
<b>Overvoltage protection:</b>	Withstands 150VDC continuously.
<b>Reverse voltage:</b>	-33VDC continuous
<b>Maximum operating current:</b>	500mA @ 12VDC. (All options included, digital outputs open.) 250mA @ 24VDC. (All options included, digital outputs open.)
<b>Typical operating current:</b>	250mA @ 12VDC. (all options passive, digital outputs open) 125mA @ 24VDC. (all options passive, digital outputs open)
<b>Measurement range:</b>	0 to 36VDC
<b>Display resolution:</b>	0.1VDC
<b>Accuracy:</b>	0.5% + 1 digit @ 24VDC



### 3.2. AC VOLTAGE INPUTS

<b>Measurement method:</b>	True RMS
<b>Sampling rate:</b>	8000 Hz
<b>Harmonic analysis:</b>	up to 31th harmonic
<b>Input voltage range:</b>	14 to 300 VAC
<b>Minimum voltage for frequency detection:</b>	15 VAC (Ph-N)
<b>Supported topologies:</b>	3 ph 4 wires star 3 ph 3 wires delta 3ph 4 wires delta 2ph 3 wires L1-L2 2ph 3 wires L1-L3 1 ph 2 wires
<b>Measurement range:</b>	0 to 330VAC ph-N (0 to 570VAC ph-ph)
<b>Common mode offset:</b>	max 100V between neutral and BAT-
<b>Input impedance:</b>	4.5M-ohms
<b>Display resolution:</b>	1VDC
<b>Accuracy:</b>	0.5% + 1 digit @ 230VAC ph-N ( $\pm 2$ VAC ph-N) 0.5% + 1 digit @ 400VAC ph-ph ( $\pm 3$ VAC ph-ph)
<b>Frequency range:</b>	DC to 500Hz
<b>Frequency display resolution:</b>	0.1 Hz
<b>Frequency accuracy:</b>	0.2% + 1 digit ( $\pm 0.1$ Hz @ 50Hz)

### 3.3. AC CURRENT INPUTS

<b>Measurement method:</b>	True RMS
<b>Sampling rate:</b>	8000 Hz
<b>Harmonic analysis:</b>	up to 31th harmonic
<b>Supported topologies:</b>	3 ph 3 CTs 3 ph 2 CTs L1-L2 3 ph 2 CTs L1-L3 2 ph 2 CTs L1-L2 2 ph 2 CTs L1-L3 1 ph 1 CT
<b>CT secondary rating:</b>	5A
<b>Measurement range:</b>	5/5 to 5000/5A minimum
<b>Input impedance:</b>	15 mili-ohms
<b>Burden:</b>	0.375W
<b>Maximum continuous current:</b>	6A
<b>Measurement range:</b>	0.1 to 7.5A
<b>Common mode offset:</b>	Max 5VAC between BAT- and any CT terminal.
<b>Display resolution:</b>	1A
<b>Accuracy:</b>	0.5% + 1 digit @ 5A ( $\pm 4.5A$ @ 5/500A full range)

#### SELECTING THE CT RATING AND CABLE SECTION:

The load on a CT should be kept minimum in order to minimize phase shift effect of the current transformer. Phase shift in a CT will cause erroneous power and power factor readings, although amp readings are correct.

Datakom advises CT rating to be selected following this table for the best measurement accuracy.

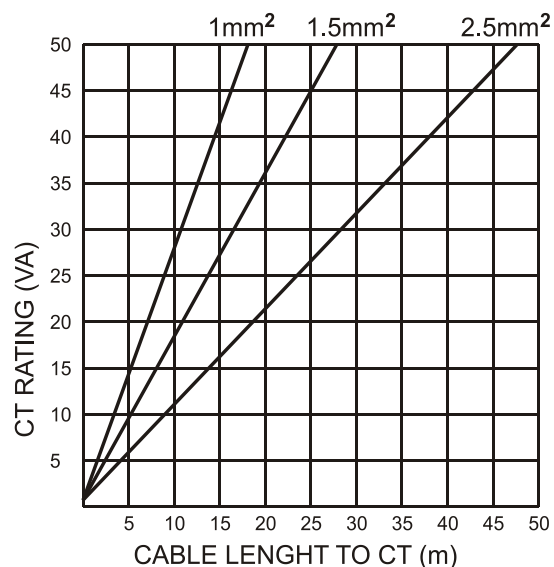

#### SELECTING THE CT ACCURACY CLASS:

The CT accuracy class should be selected in accordance with the required measurement precision. The accuracy class of the Datakom controller is 0.5%. Thus 0.5% class CTs are advised for the best result.



- **Current Transformers must be used for current measurement. No direct connection allowed.**
- **No common terminals or grounding allowed.**

**CONNECTING CTs:**

Be sure of connecting each CT to the related phase input with the correct polarity. Mixing CTs between phases will cause faulty power and pf readings.

Many combinations of incorrect CTs connections are possible, so check both order of CTs and their polarity. Reactive power measurement is affected by incorrect CTs connection in similar way as active power measurement.

**CORRECT CT CONNECTIONS**

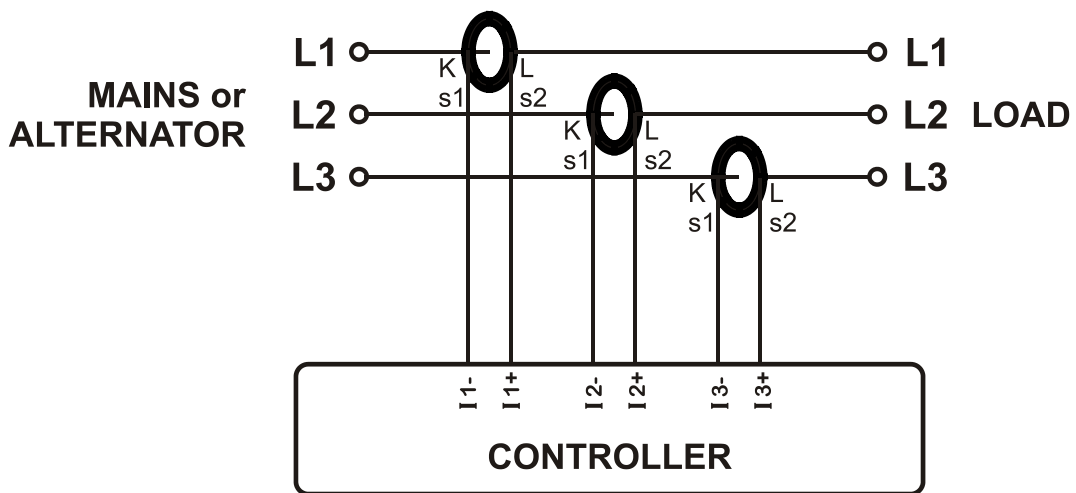

Let's suppose that the genset is loaded with 100 kW on each phase. The load Power Factor (PF) is 1. Measured values are as follows:

	kW	kVAr	kVA	pf
Phase L1	100.0	0.0	100	1.00
Phase L2	100.0	0.0	100	1.00
Phase L3	100.0	0.0	100	1.00
<b>Total</b>	<b>300.0</b>	<b>0.0</b>	<b>300</b>	<b>1.00</b>

**EFFECT OF POLARITY REVERSAL**

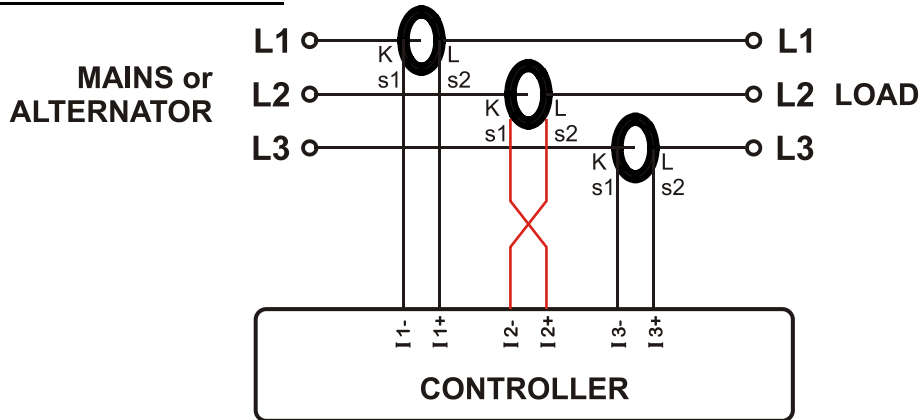

The generator is still loaded with 100 kW On each phase. The load Power Factor (PF) is 1. PF in phase L2 will show -1,00 due to reverse CT polarity. The result is that total generator power displayed by the controller is 100 kW. Measured values are as follows:

	kW	kVAr	kVA	pf
Phase L1	100.0	0.0	100	1.00
Phase L2	-100.0	0.0	100	-1.00
Phase L3	100.0	0.0	100	1.00
<b>Total</b>	<b>100.0</b>	<b>0.0</b>	<b>300</b>	<b>0.33</b>

**EFFECT OF PHASE SWAPPING**

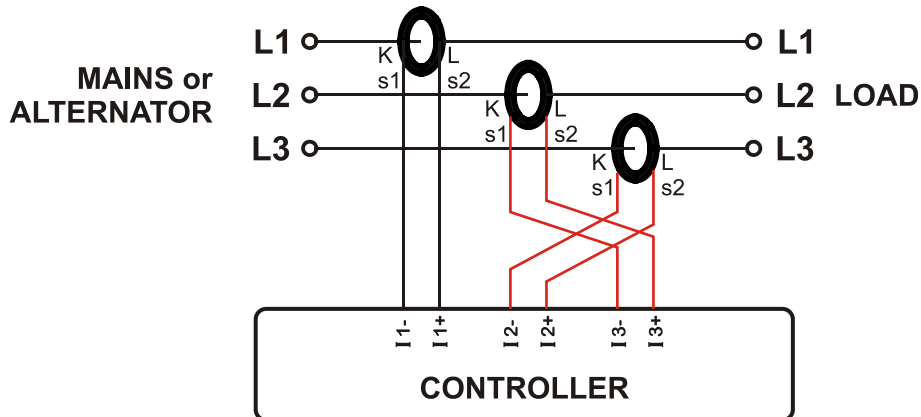

The generator is still loaded with 100 kW on each phase. The load Power Factor (PF) is 1. PF in phases L2 and L3 will show -0,50 due to phase shift between voltages and currents which is caused by CT swapping. The result is that total generator power displayed by controller is 0 kW. Measured values are as follows:

	kW	kVAr	kVA	pf
Phase L1	100.0	0.0	100	1.00
Phase L2	-50.0	86.6	100	-0.50
Phase L3	-50.0	-86.6	100	-0.50
<b>Total</b>	<b>0.0</b>	<b>0.0</b>	<b>300</b>	<b>0.0</b>

### 3.4. DIGITAL INPUTS

<b>Type of inputs:</b>	all configurable
<b>Function selection:</b>	from list
<b>Contact type:</b>	Normally open or normally closed (programmable)
<b>Switching:</b>	Battery negative or battery positive (programmable)
<b>Structure:</b>	47 k-ohms resistor to battery positive, 110k-ohms to battery negative.
<b>Measurement:</b>	Analog voltage measurement.
<b>Open circuit voltage:</b>	70% of battery voltage
<b>Low level threshold:</b>	35% of battery voltage
<b>High level threshold:</b>	85% of battery voltage
<b>Maximum input voltage:</b>	+100VDC with respect to battery negative
<b>Minimum input voltage:</b>	-70VDC with respect to battery negative
<b>Noise filtering:</b>	yes

### 3.5. ANALOG SENDER INPUTS AND SENDER GROUND

<b>Type of inputs:</b>	all configurable, additional sender ground input
<b>Function selection:</b>	from list
<b>Structure:</b>	667 ohms resistor polarizing to 3.3VDC
<b>Measurement:</b>	Analog resistor measurement.
<b>Open circuit voltage:</b>	+3.3VDC
<b>Short circuit current:</b>	5mA
<b>Measurement range:</b>	0 to 5000 ohms.
<b>Open circuit threshold:</b>	5000 ohms.
<b>Resolution:</b>	1 ohms @ 300 ohms or lower
<b>Accuracy:</b>	2 %+1 ohm ( $\pm 7$ ohms @300 ohms)
<b>Common mode voltage range:</b>	$\pm 3$ VDC
<b>Noise filtering:</b>	yes

### 3.6. CHARGE INPUT TERMINAL

The Charge terminal is both an input and output.

When the engine is ready to run, this terminal supplies the excitation current to the charge alternator.

The excitation circuit is equivalent to a 2W lamp.

The threshold voltages for warning and shutdown alarm are adjustable through program parameter.

<b>Structure:</b>	<ul style="list-style-type: none"> <li>• battery voltage output through 100 ohm resistor</li> <li>• voltage measurement input</li> </ul>
<b>Output current:</b>	100mA @12VDC 200mA @24VDC
<b>Voltage measurement resolution:</b>	0.1VDC
<b>Voltage measurement accuracy:</b>	2% + 0.1V (0.9V @30VDC)
<b>Charge Fail Warning Threshold:</b>	adjustable
<b>Charge Fail Shutdown Alarm Threshold:</b>	adjustable
<b>Open circuit voltage:</b>	battery positive
<b>Overvoltage protection:</b>	> 500VDC continuous, with respect to battery negative
<b>Reverse voltage protection:</b>	-30VDC with respect to battery negative

### 3.7. MAGNETIC PICKUP INPUT

<b>Structure:</b>	Differential frequency measurement input
<b>Input impedance:</b>	50 k-ohms
<b>Input voltage:</b>	0.5VAC-RMS to 30VAC-RMS
<b>Max common mode voltage:</b>	± 5VDC
<b>Frequency range:</b>	10Hz to 10 kHz
<b>Resolution:</b>	1 rpm
<b>Accuracy:</b>	0.2% + 1 rpm (±3rpm @1500 rpm)
<b>Flywheel teeth range:</b>	1 to 500



**Do not share MPU with other devices.**

### 3.8. MAINS CONTACTOR OUTPUT

<b>Structure:</b>	Relay output, normally closed contact. One terminal is internally connected to mains phase L1 input.
<b>Max switching current:</b>	16A @250VAC
<b>Max switching voltage:</b>	440VAC
<b>Max switching power:</b>	3000VA

### 3.9. GENERATOR CONTACTOR OUTPUT

<b>Structure:</b>	Relay output, normally open contact. One terminal is internally connected to genset phase L1 input.
<b>Max switching current:</b>	16A @250VAC
<b>Max switching voltage:</b>	440VAC
<b>Max switching power:</b>	4000VA

### 3.10. DIGITAL OUTPUTS

<b>Structure:</b>	Positive relay output, NO contact
<b>Function</b>	programmable function, selectable from list.
<b>Max continuous current:</b>	10.0 ADC
<b>Max switching voltage:</b>	33 VDC

### 3.11. INPUT/OUTPUT EXTENSION

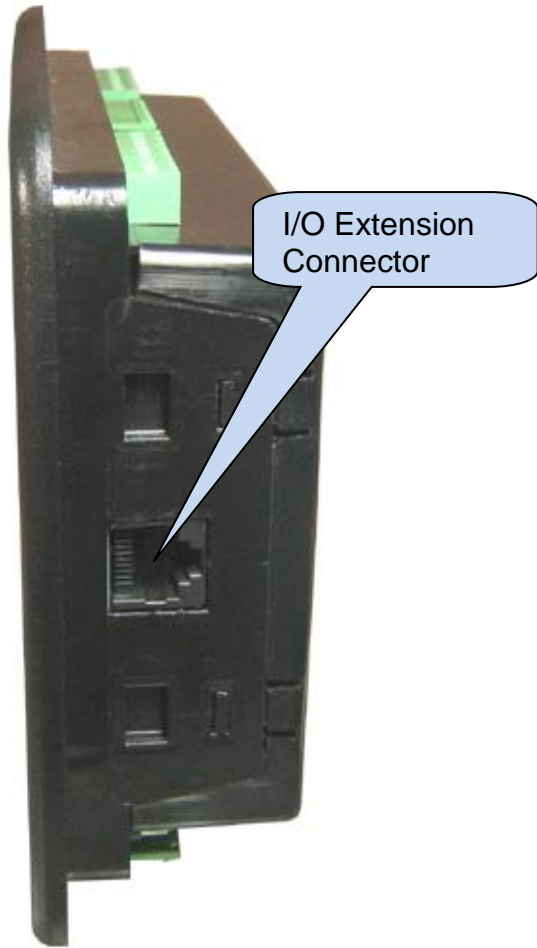

The module provides resources for 32 additional digital inputs and 32 additional digital outputs.

Digital inputs can be extended using **DKG-188 Digital Input Extension** modules, each one providing 8 inputs. Digital inputs are programmable through the main controller. The switching characteristic is not programmable and must be battery negative. Any function can be assigned to digital inputs.

Digital outputs can be extended using **DKG-186 Fet Extension** modules, each one providing 8 outputs. Digital outputs have the same electrical characteristics as on board outputs. They have programmable functions through the main controller. Any function can be assigned to any output.

Input and output extension modules are connected to the main controller in a cascade structure, in any order. The connection cable is provided with each extension module.

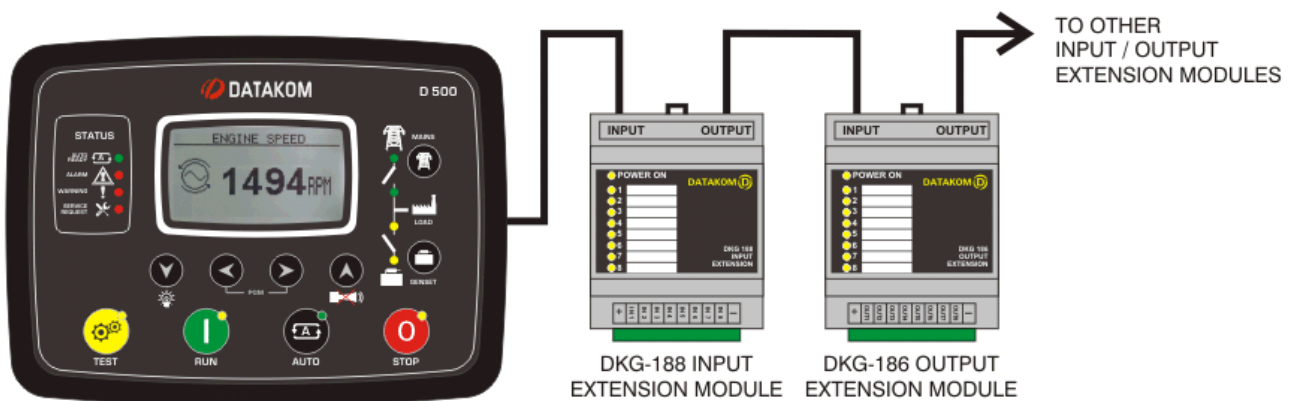



### 3.12. RS-485 PORT

<b>Structure:</b>	RS-485, non isolated.
<b>Connection:</b>	3 wires (A-B-GND). Half duplex.
<b>Baud rate:</b>	2400-57600 bauds, selectable
<b>Data type:</b>	8 bit data, no parity, 1 bit stop
<b>Termination:</b>	External 120 ohms required
<b>Common mode voltage:</b>	-0.5 VDC to +7VDC, internally clamped by transient suppressors.
<b>Max distance:</b>	1200m @ 9600 bauds (with 120 ohms balanced cable) 200m @ 57600 bauds (with 120 ohms balanced cable)

The RS-485 port features MODBUS-RTU protocol. Multiple modules (up to 128) can be paralleled on the same RS-485 bus for data transfer to automation or building management systems.



**The Modbus register list is available at Datakom technical support.**

### 3.13. RS-232 PORT

<b>Description:</b>	RS-232, non isolated.
<b>Functionality:</b>	MODBUS RTU, External GSM modem, external PSTN modem
<b>Connector:</b>	DB-9 (9 pins male)
<b>Connection:</b>	5 wires (Rx-Tx-DTR-CxD-GND). Full duplex.
<b>Baud rate:</b>	2400-57600 bauds, selectable
<b>Data type:</b>	8 bit data, no parity, 1 bit stop
<b>Max distance:</b>	15m
<b>Cable type:</b>	Standard modem cable

### 3.14. J1939-CANBUS PORT

<b>Structure:</b>	CANBUS, non isolated.
<b>Connection:</b>	3 wires (CANH-CANL-GND).
<b>Data rate:</b>	250 kbps
<b>Termination:</b>	Internal 120 ohms provided
<b>Common mode voltage:</b>	-0.5 VDC to +15 VDC, internally clamped by transient suppressors.
<b>Max distance:</b>	200m with 120 ohm balanced cable

### 3.15. USB DEVICE PORT

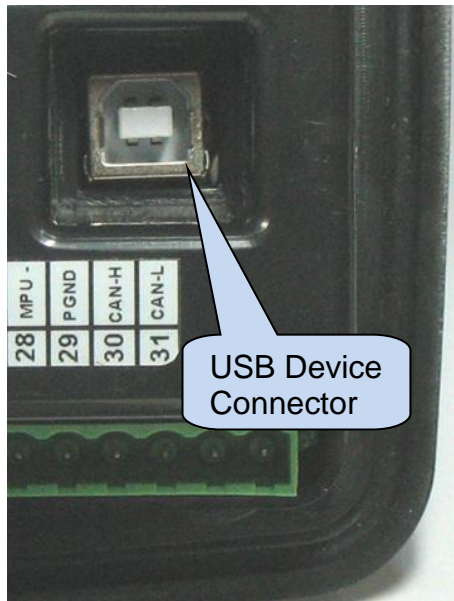

<b>Description:</b>	USB 2.0, not isolated, HID mode
<b>Data rate:</b>	Full Speed 1.5/12 Mbits/s, auto detecting
<b>Connector:</b>	USB-B (printer connector)
<b>Cable length:</b>	Max 6m
<b>Functionality:</b>	Modbus, FAT32 for firmware upgrade (boot loader mode only)

The USB-Device port is designed to connect the module to a PC. Using the RainbowPlus software, programming, control of the genset and monitoring of measured parameters are achieved.

The RainbowPlus software can be downloaded from [www.datakom.com.tr](http://www.datakom.com.tr) website.

The connector on the module is of USB-B type. Thus A to B type USB cable should be used. This is the same cable used for USB printers.

For more details about programming, control and monitoring please refer to RainbowPlus user manual.



**The battery voltage must be connected.**

### 3.16. GSM MODEM (OPTIONAL)

The optional internal GSM modem offers the advantage of being internally powered and is fully compatible with the unit. It does not require any special setup.

The 1800/1900 MHz magnetic antenna together with its 2 meter cable is supplied with the internal modem option. The antenna is intended to be placed outside of the genset panel for the best signal reception.



The module requires a GPRS enabled SIM card for full functionality. Voice-only type SIM cards will usually not function properly.

Please refer to **GSM Modem Configuration Guide** for more details.

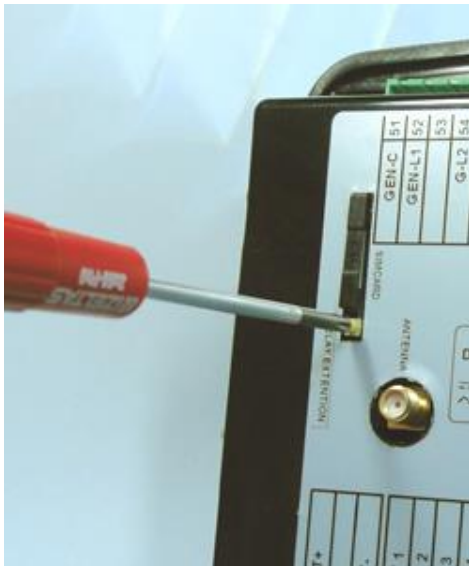

**SIM CARD EXTRACTION**



**SIM CARD EXTRACTION/INSERTION**

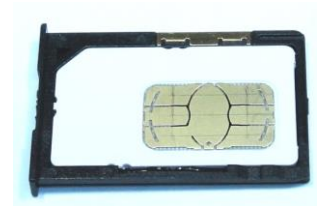

**SIM CARD PLACEMENT**

<b>Description:</b>	Quad-band GSM/GPRS 850/900/1800/1900MHz module. GPRS multi-slot class 12/12 GPRS mobile station class B Compliant to GSM phase 2/2+. – Class 4 (2 W @850/ 900 MHz) – Class 1 (1 W @ 1800/1900MHz)
<b>Functionality:</b>	Web Client, SMTP, Modbus TCP/IP (client), SMS, e-mail
<b>Operating temp range:</b>	-40°C to +85 °C
<b>Data speed:</b>	max. 85.6 kbps (download), 85.6 kbps (upload)
<b>SIM card type:</b>	external SIM 3V/1.8V, GPRS enabled
<b>Antenna:</b>	Quad band, magnetic, with 2m cable
<b>Module certificates:</b>	CE, FCC, ROHS, GCF, REACH

**LOCATION DETERMINATION VIA GSM**

The unit determines automatically the geographical position through the GSM network. No settings are necessary for this.

This feature is especially useful for the remote monitoring where the controller will appear automatically at its geo-position or for mobile gensets.

Although the controller supports also GPS location determination for more precise positioning, the GSM based location is free of charge, available everywhere, even where GPS signal is not available.



**The location precision will depend of the GSM system. In highly populated areas, the precision is good (a few hundred meters), but rural areas may lead to errors of a many kilometers.**

## 4. TOPOLOGIES

Various topologies are selectable through program parameter.

The topology is independently selectable for both genset and mains sections.

In following drawings the connections are shown for the alternator. Current transformers are supposed connected to the alternator side.

Similar topologies re available for the mains side as well.

### 4.1. SELECTING THE TOPOLOGY

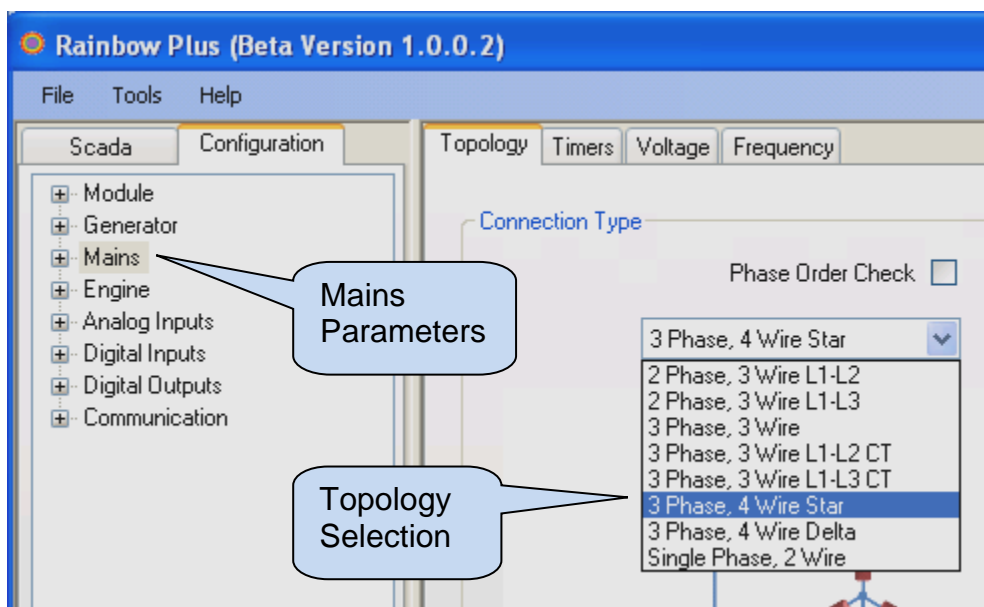
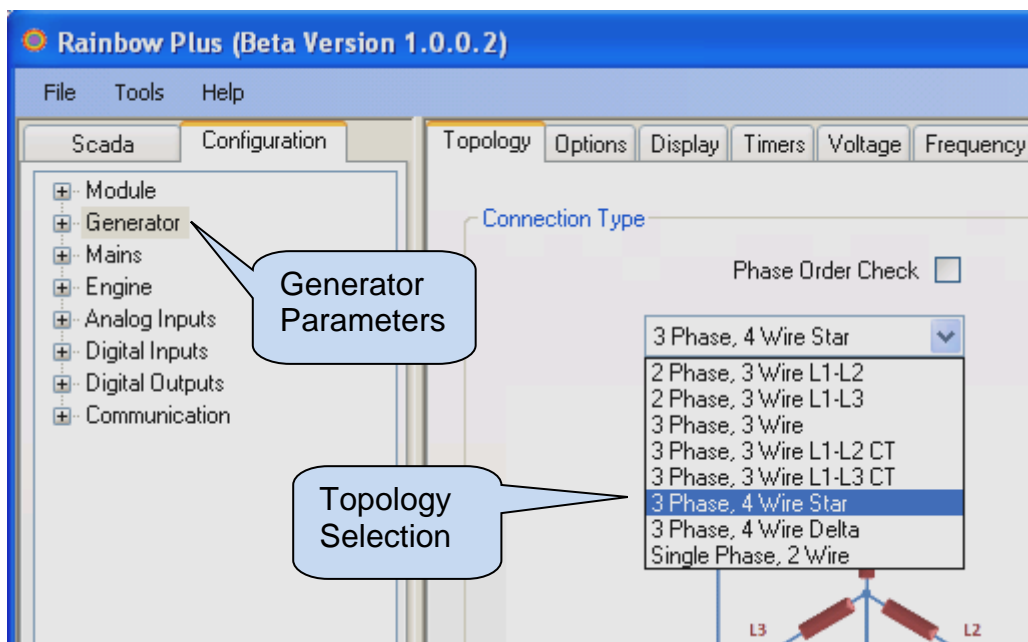

**4.2. 3 PHASE, 4 WIRE, STAR**

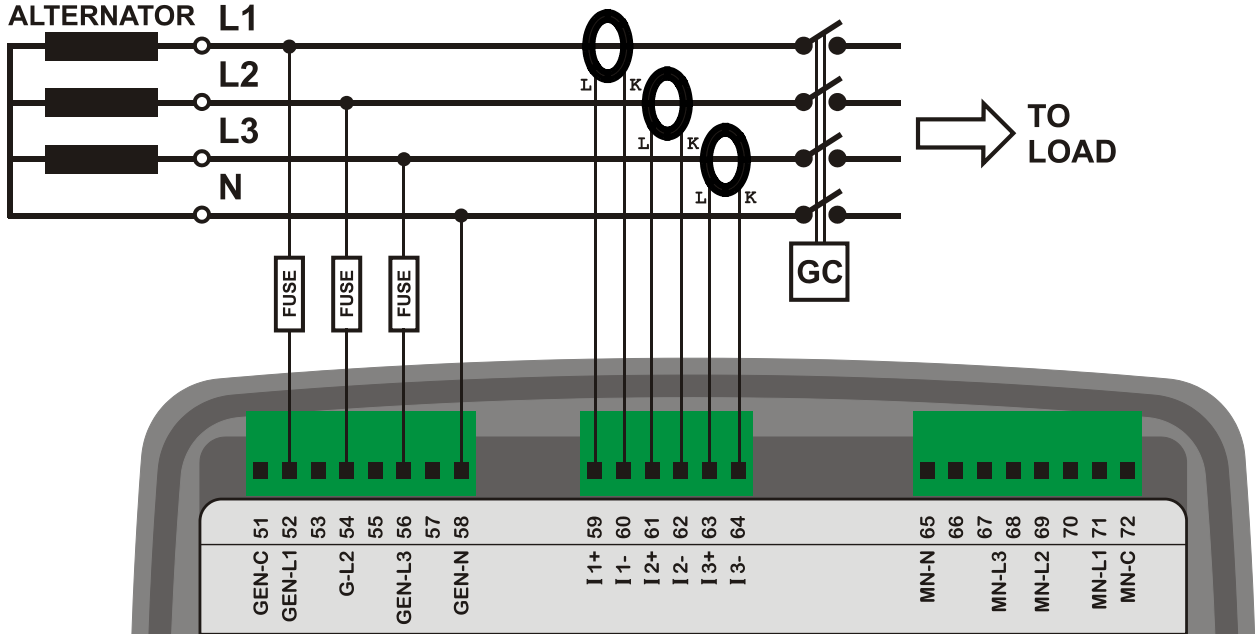

**4.3. 3 PHASE, 3 WIRE, DELTA**

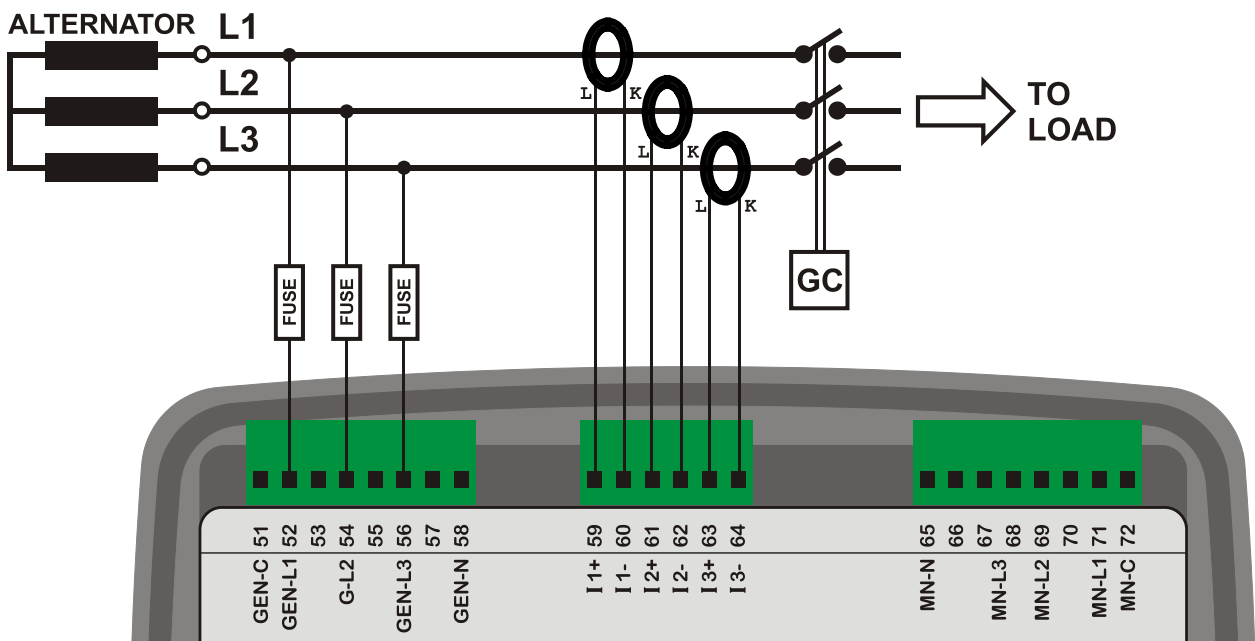

**4.4. 3 PHASE, 4 WIRE, DELTA**

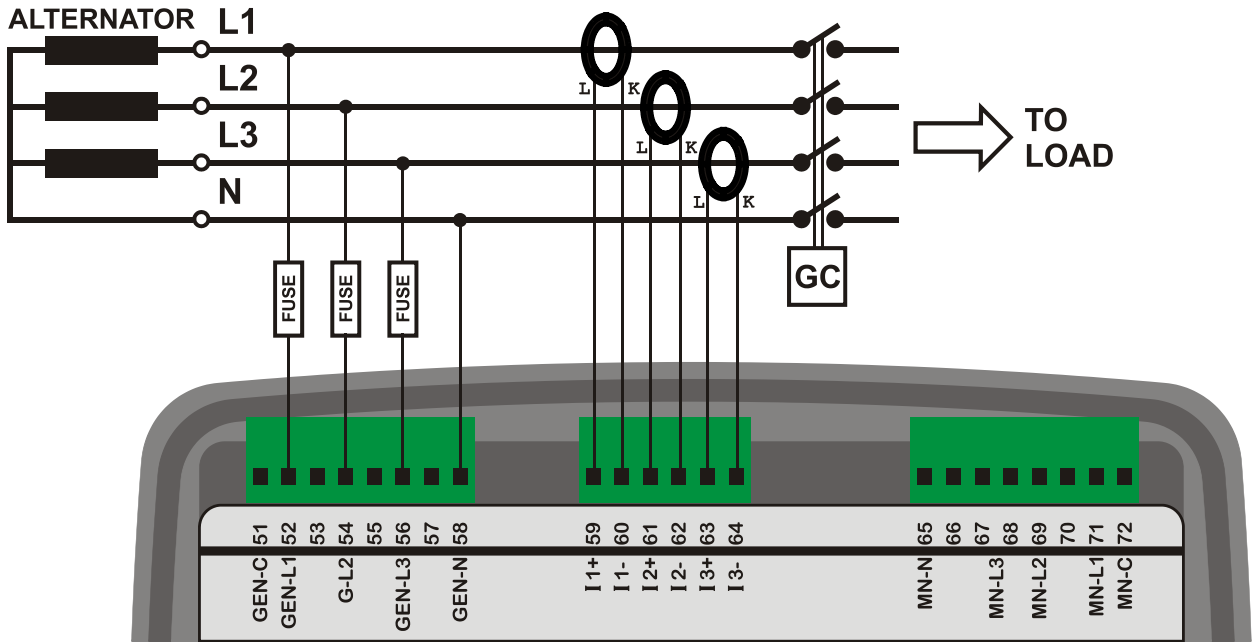

**4.5. 3 PHASE, 3 WIRE, DELTA, 2 CT (L1-L2)**

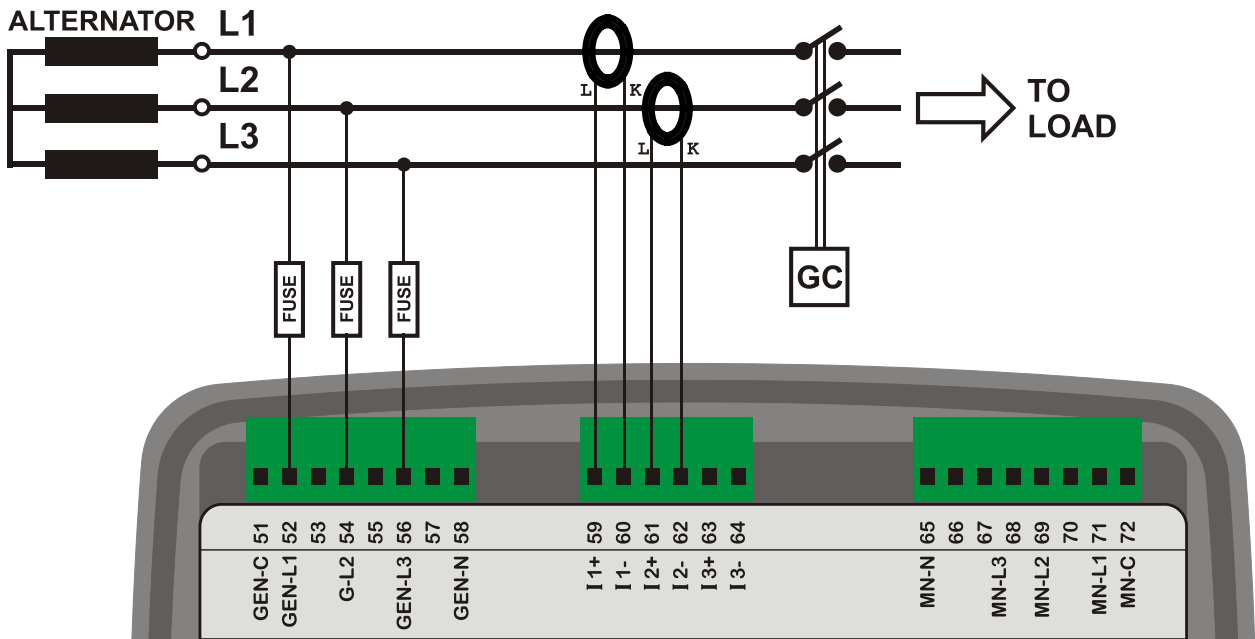

**4.6. 3 PHASE, 3 WIRE, DELTA, 2 CT (L1-L3)**

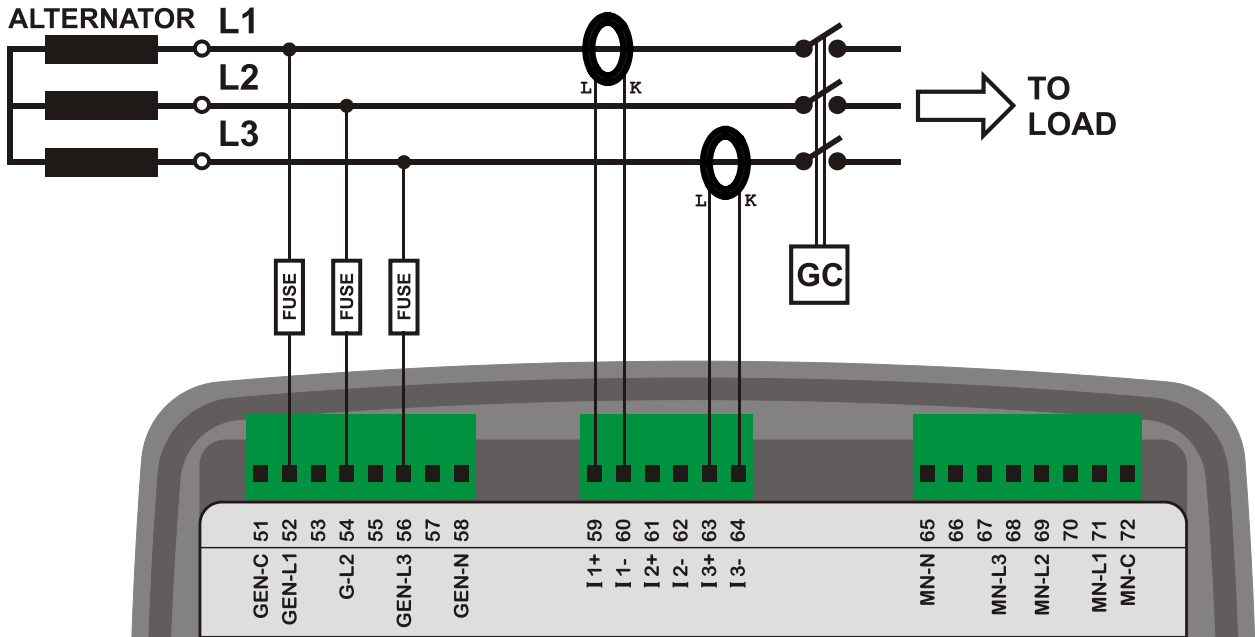

**4.7. 2 PHASE, 3 WIRE, DELTA, 2 CTs (L1-L2)**

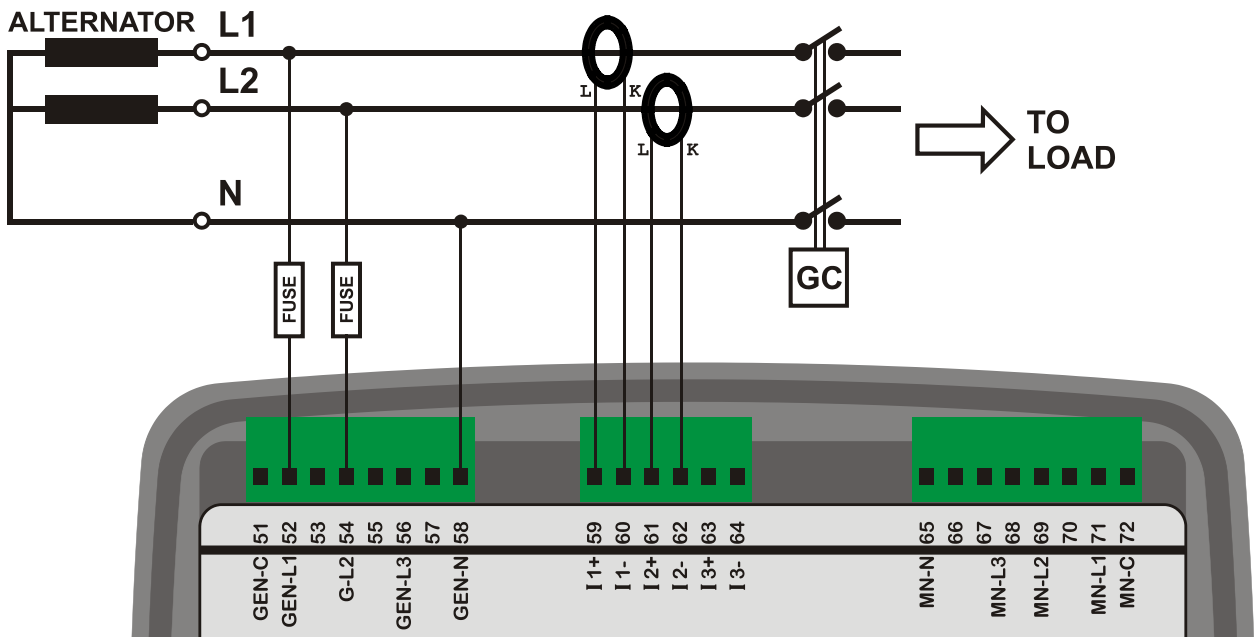



### 4.8. 2 PHASE, 3 WIRE, DELTA, 2 CTs (L1-L3)

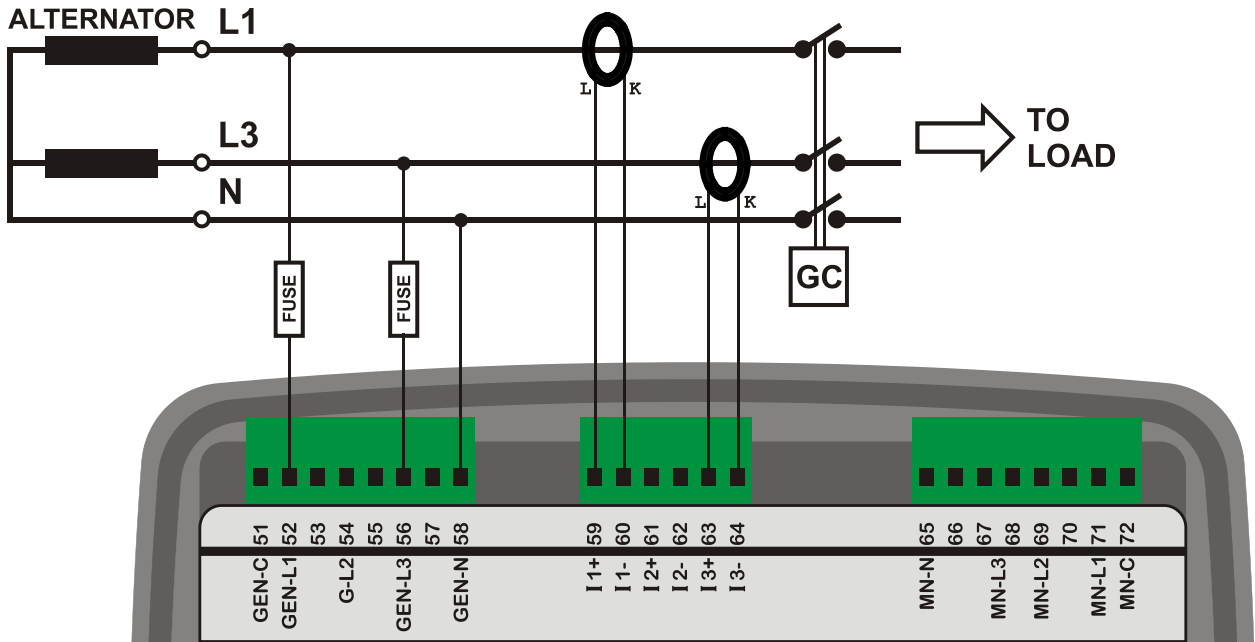

### 4.9. 1 PHASE, 2 WIRE

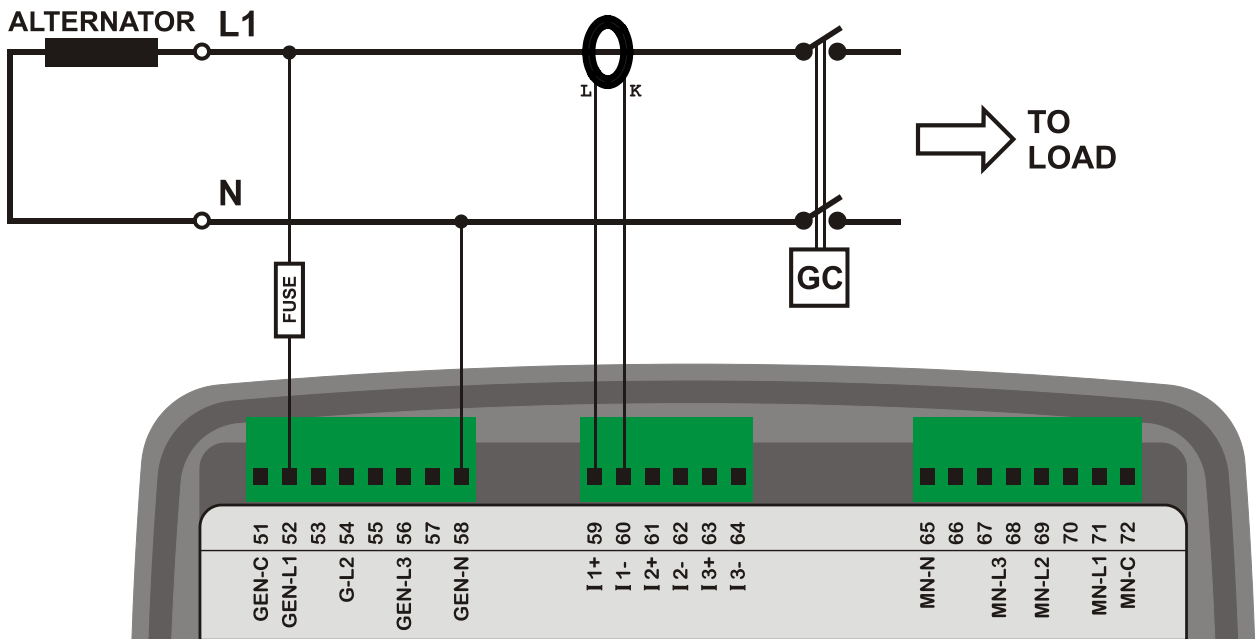

## 5. FUNCTIONALITIES

The same unit provides different functionalities through parameter setting. Thus a single stock item will fulfill various duties, minimizing stock cost.

### 5.1. CT LOCATION SELECTION

CTs may be placed at alternator or load busbars. The CT location selection is configured with **Controller Configuration > CT Location** parameter.

When CTs are located at the alternator side, then mains current and power parameters will not be displayed.

When CTs are located at load side, then both mains and genset currents and power parameters will be displayed, based on contactor positions.

Please review AMF functionality connection diagrams for CT connection details.

### 5.2. AMF FUNCTIONALITY

When AMF functionality is selected, the unit will monitor mains voltages, provide mains and genset contactor control, run the engine and provide engine and alternator instrumentation and fault monitoring.

The unit features both MPU and J1939 CANBUS inputs. Thus both mechanical and electronic engines are supported.

The unit provides control outputs for both contactors and motorized circuit breakers.

### 5.3. ATS FUNCTIONALITY

When ATS functionality is selected, the unit will monitor mains voltages, provide mains and genset contactor control and issue a Remote Start signal to the engine controller. It will provide alternator instrumentation and fault monitoring.

Engine instrumentation and protection will be insured by the engine controller.

### 5.4. REMOTE START FUNCTIONALITY

When the Remote Start functionality is selected, the unit will wait for a Remote Start signal from external controller. Upon reception of this signal, it will run the engine, and provide engine and alternator instrumentation and fault monitoring. The genset contactor/MCB control functionality will be available.

The unit features both MPU and J1939 CANBUS inputs. Thus both mechanical and electronic engines are supported.

## 5.5 ENGINE CONTROLLER FUNCTIONALITY

When the Engine Controller functionality is selected, genset electrical measurements and protections will be disabled. The unit is supposed to control an engine without alternator.

When the **Engine Control Mode** is activated:

-the unit will not display genset AC parameters (volts, amps, kW and pf).

-genset voltage and frequency protections are disabled. However engine rpm protections will be active.

Note that the engine controller functionality is compatible with both AMF and Remote Start modes.

When AMF and Engine controller modes are selected, the unit will monitor the mains and will run the engine upon mains failure. This functionality is useful for the backup electric motor driven systems during mains failures, like fire pump or irrigation systems.

When Remote Start and Engine controller modes are selected, the unit will start and stop the engine with external signal only.

The unit features both MPU and J1939 CANBUS inputs. Thus both mechanical and electronic engines are supported.



**It is strongly recommended to wire speed detection through MPU or J1939-CANBUS and enter correct low and high rpm limit values in order to preserve engine speed protection.**

## 5.6. REMOTE DISPLAY UNIT FUNCTIONALITY

The unit is able to become the remote display and control panel of another identical module.

The connection between two modules is done through RS-485 ports. For the best results, a 120 ohms balanced, low capacitance cable should be used.

The data rate between modules is selectable between 2400 and 57600 bauds.

A high data rate offers better synchronization between modules, but the distance will be limited.

Typically at 57600 bauds and with adequate cable, the distance will be 200m maximum.

At 9600 bauds and adequate cable the distance can go up to 1200m.

Below settings are necessary:

PARAMETER	MAIN UNIT	REMOTE DISPLAY UNIT
Annunciator Mode	0	1
RS-485 Enable	1	1
RS-485 Baud Rate	any	same as main unit
Modbus Slave Address	any	same as main unit



**The remote display panel should be powered up with an isolated voltage source, like a wall adapter. Otherwise damages due to ground potential differences may occur.**

## 5.7. 400HZ OPERATION

The standard unit is also 400Hz enabled. The nominal frequency setting accepts up to 500Hz. Usual low and high limits will apply without any special setting.

The measurement system of the unit allows frequencies up to 1000Hz to be measured precisely. However the display is limited to 650Hz. Frequencies over 650Hz will be displayed as 650Hz.

The bandwidth of the harmonic analyzer is limited to 1800Hz. Thus in case of a 400Hz system, only the 3<sup>rd</sup> harmonic will be displayed.

The waveform display of a 400Hz signal will be represented with 10 points. It will not be as accurate as 50/60Hz signals.

For more details please read chapter: "Waveform Display & Harmonic Analysis".

## 6. CONNECTION DIAGRAMS

### 6.1. AMF FUNCTIONALITY, CTs AT LOAD SIDE

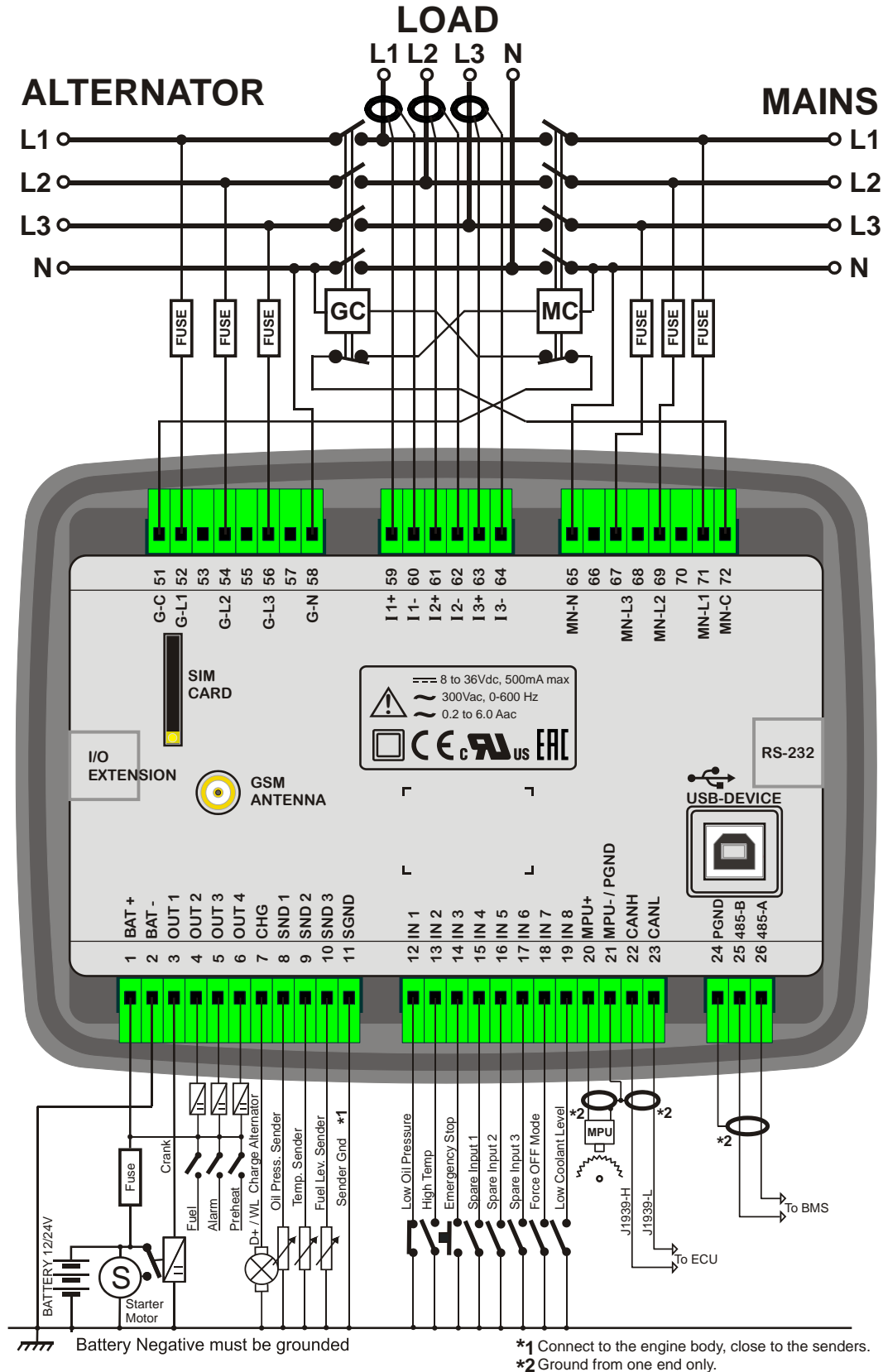

6.2. AMF FUNCTIONALITY, CTs AT ALTERNATOR SIDE

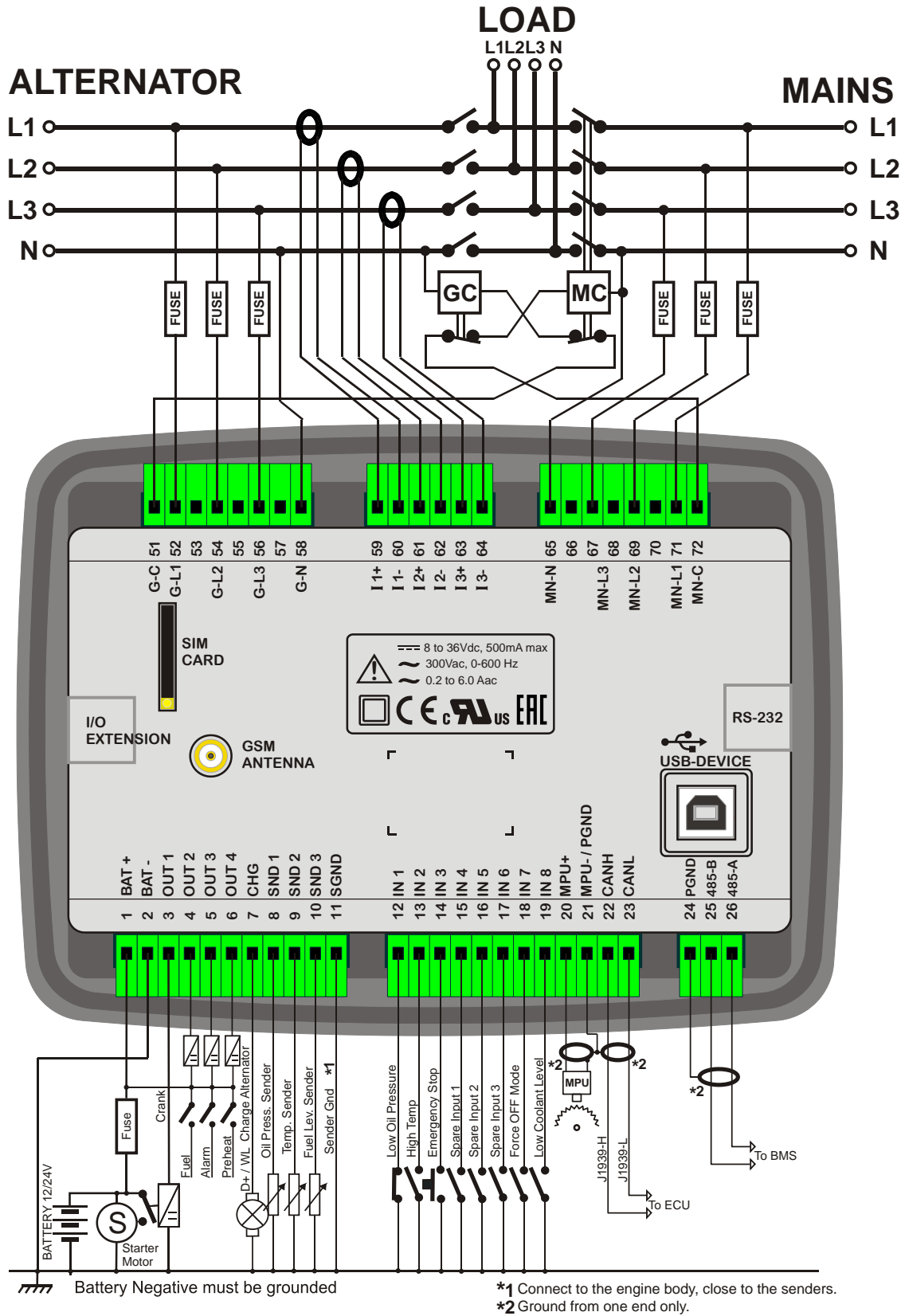

### 6.3. ATS FUNCTIONALITY

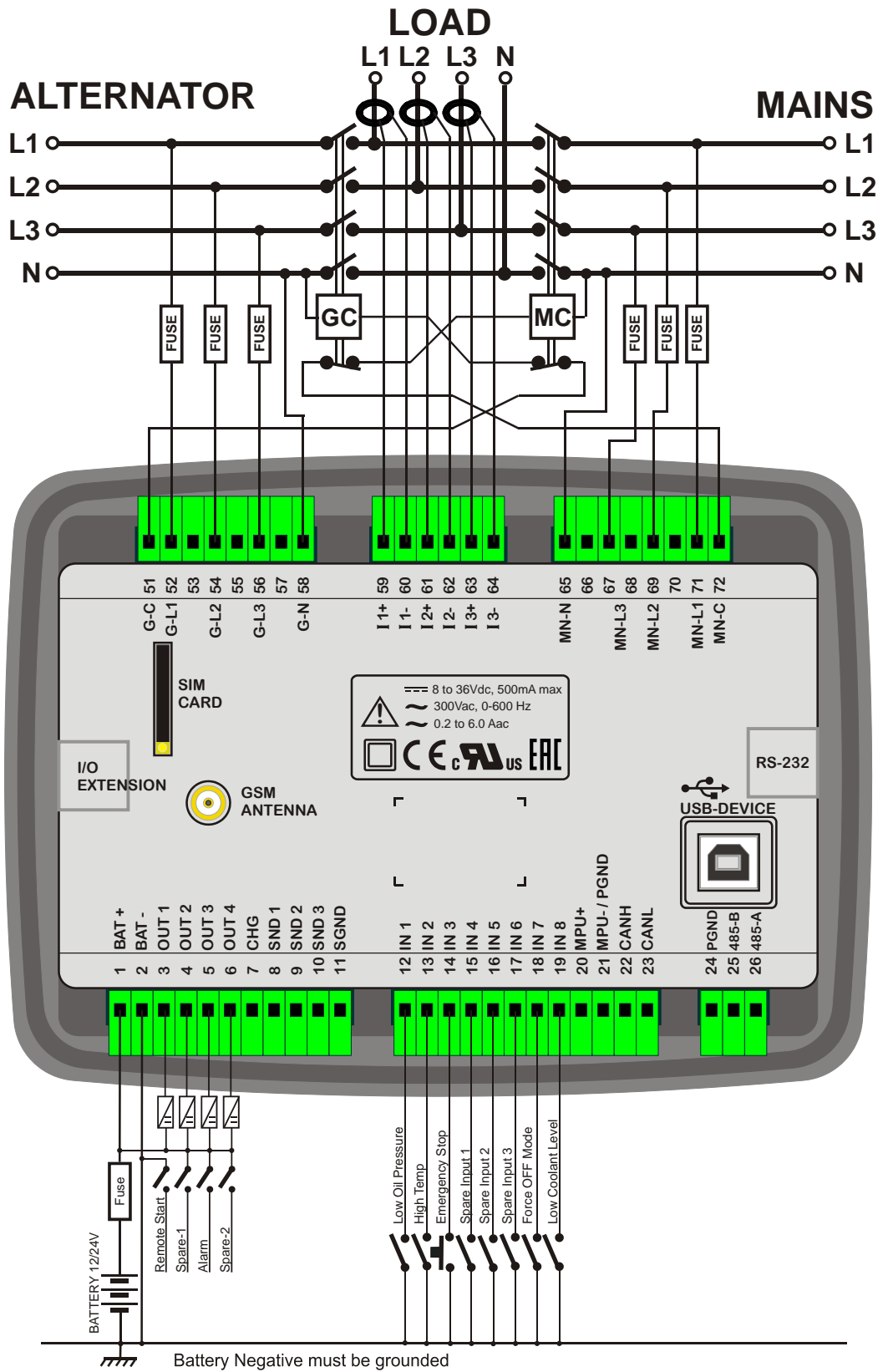

## 6.4. REMOTE START FUNCTIONALITY

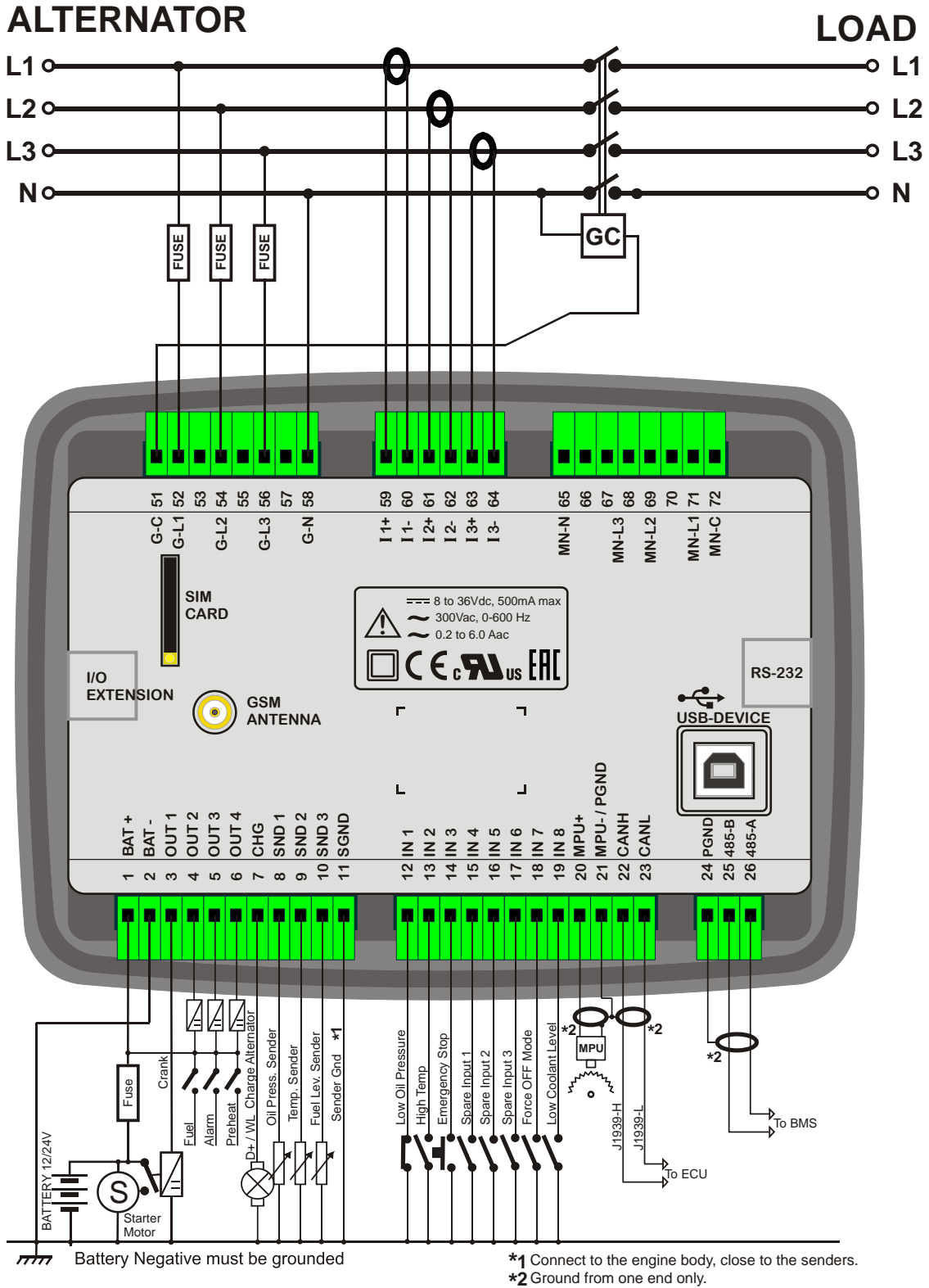



6.5. ENGINE CONTROL FUNCTIONALITY

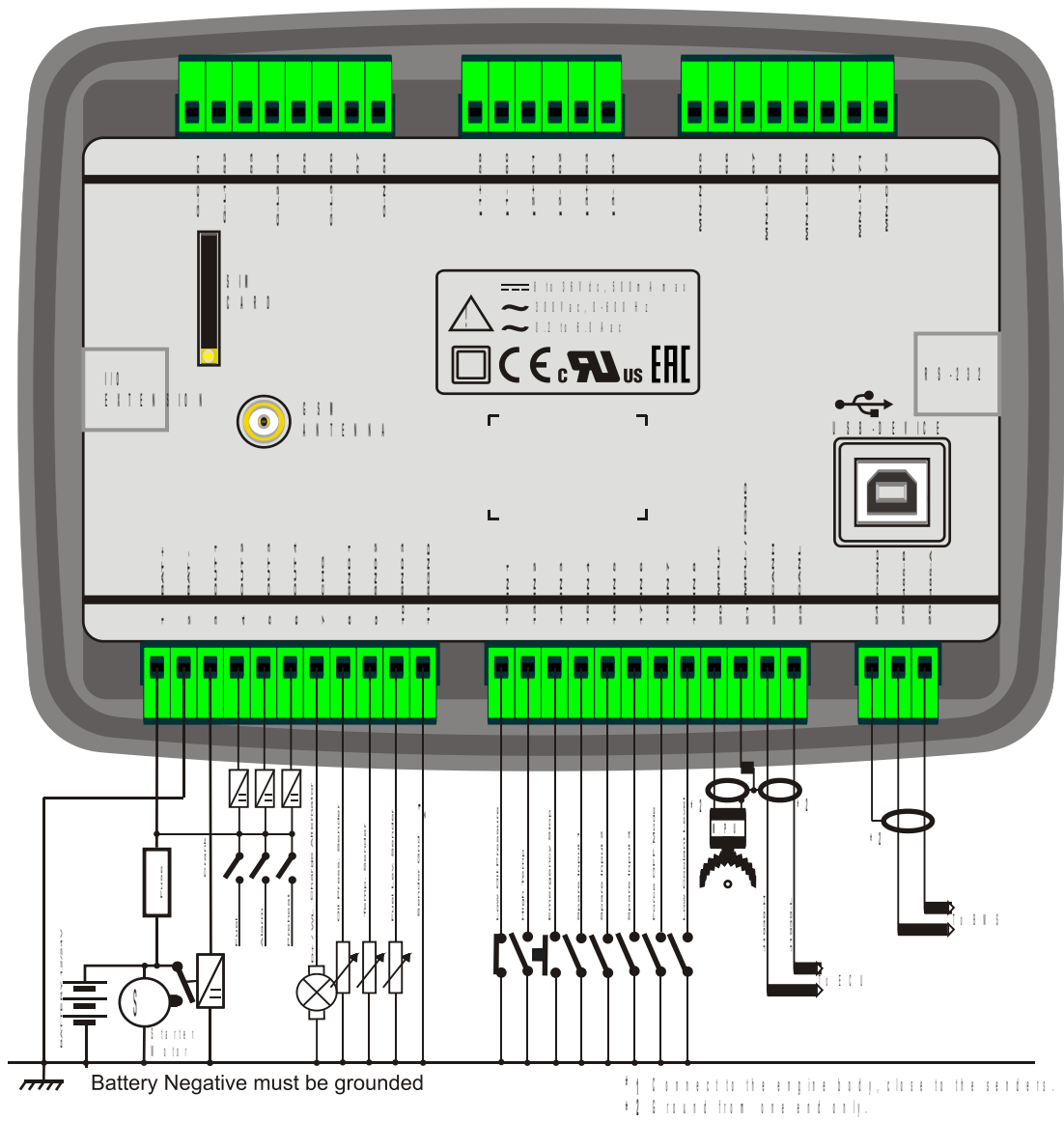

**6.6. REMOTE DISPLAY PANEL FUNCTIONALITY**

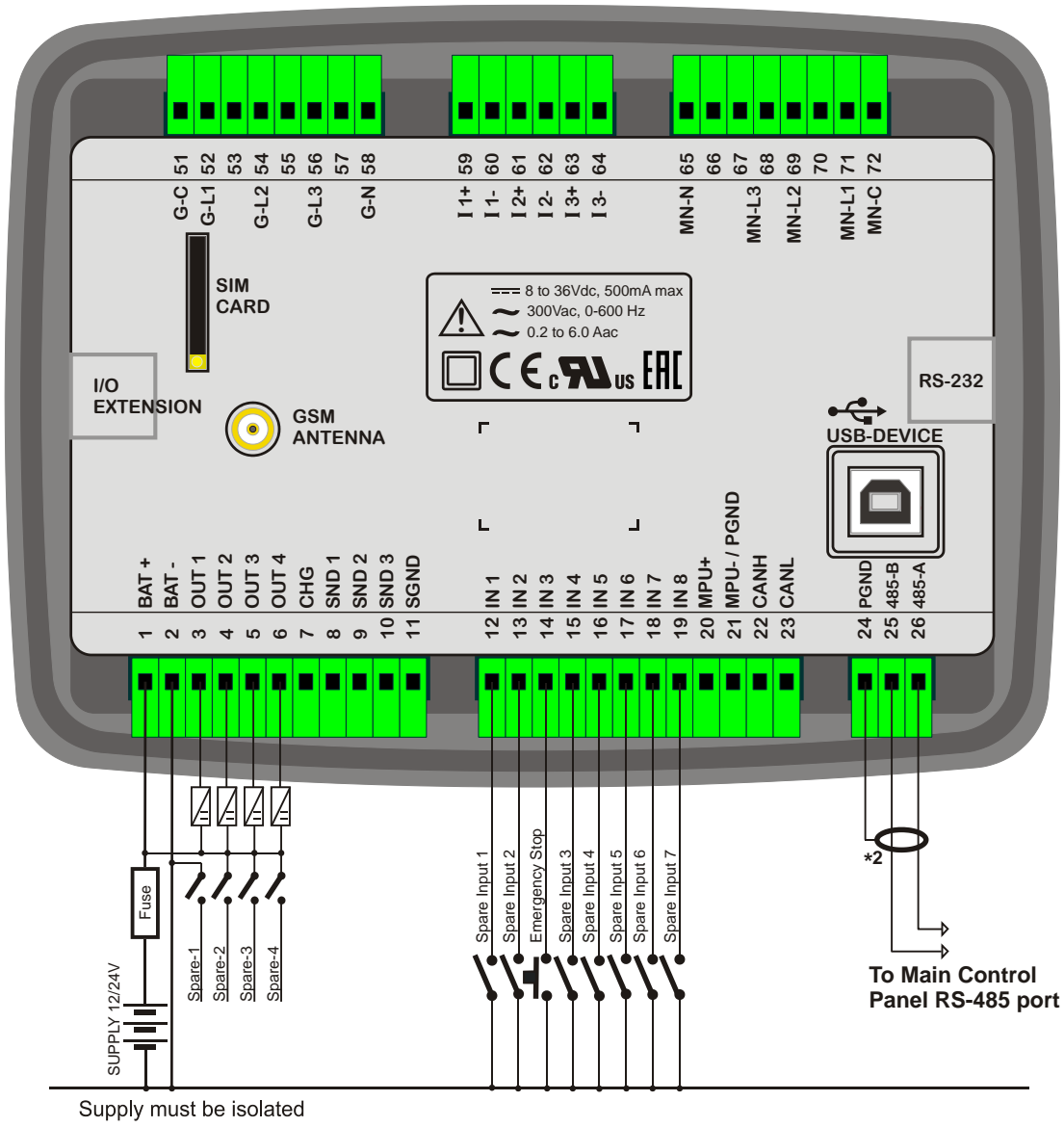

## 7. TERMINAL DESCRIPTION

Term	Function	Technical data	Description
1	<b>BATTERY POSITIVE</b>	+12 or 24VDC	The positive terminal of the DC Supply.
2	<b>BATTERY NEGATIVE</b>	0 VDC	Power supply negative connection.
3	<b>DIGITAL OUTPUT 1</b>	Protected Semiconductor Outputs 1A/28VDC	This relay has programmable function, selectable from a list. Factory set as <b>CRANK</b> output.
4	<b>DIGITAL OUTPUT 2</b>		This relay has programmable function, selectable from a list. Factory set as <b>FUEL</b> output.
5	<b>DIGITAL OUTPUT 3</b>		This relay has programmable function, selectable from a list. Factory set as <b>ALARM</b> output.
6	<b>DIGITAL OUTPUT 4</b>		This relay has programmable function, selectable from a list. Factory set as <b>PREHEAT</b> output.
7	<b>CHARGE</b>	Input and output	Connect the charge alternator's D+ terminal to this terminal. This terminal will supply the excitation current and measure the voltage of the charge alternator.
8	<b>ANALOG SENDER 1 (OIL PRESSURE SENDER)</b>	Resistor measuring input, 0-5000 ohms	Connect to the oil pressure sender. Do not connect the sender to other devices.
9	<b>ANALOG SENDER 2 (COOLANT TEMP. SENDER)</b>		Connect to the coolant temperature sender. Do not connect the sender to other devices.
10	<b>ANALOG SENDER 3 (FUEL LEVEL SENDER)</b>		Connect to the fuel level sender. Do not connect the sender to other devices.
11	<b>SENDER GROUND</b>	Input	Ground potential for analog senders. Connect to the engine body, close to senders.

Term	Function	Technical data	Description
12	<b>DIGITAL INPUT 1</b>	Digital Inputs, 0-30Vdc	The input has programmable function. Factory set as <b>LOW OIL PRESSURE SWITCH</b> .
13	<b>DIGITAL INPUT 2</b>		The input has programmable function. Factory set as <b>HIGH TEMP SWITCH</b> .
14	<b>DIGITAL INPUT 3</b>		The input has programmable function. Factory set as <b>EMERGENCY STOP</b> .
15	<b>DIGITAL INPUT 4</b>		The input has programmable function. Factory set as <b>SPARE INPUT-1</b> .
16	<b>DIGITAL INPUT 5</b>		The input has programmable function. Factory set as <b>SPARE INPUT-2</b> .
17	<b>DIGITAL INPUT 6</b>		The input has programmable function. Factory set as <b>SPARE INPUT-3</b> .
18	<b>DIGITAL INPUT 7</b>		The input has programmable function. Factory set as <b>FORCE OFF MODE</b> .
19	<b>DIGITAL INPUT 8</b>		AC signal driving output and detector input

Term	Function	Technical data	Description
20	MPU +	Analog input, 0.5 to 30V-AC	Connect one terminal of the MPU unit to this input. Use a twisted cable pair or coaxial cable for best results.
21	MPU - / PROTECTION GROUND	Output 0Vdc	Connect one terminal of the MPU unit to this input. Use a twisted cable pair or coaxial cable for best results. Connect the protective shield of the CANBUS cable to this terminal.
22	CANBUS-H	Digital communication port	Connect the J1939 port of an electronic engine to these terminals. The 120 ohm terminating resistors are inside the unit. Please do not connect external resistors. Use a twisted cable pair or coaxial cable for best results.
23	CANBUS-L		

Term	Function	Technical data	Description
21	PROTECTION GROUND	Output 0Vdc	Connect the protective shield of the RS-485 cable to this terminal.
25	RS-485 B	Digital communication port	Connect the A-B data lines of the RS-485 link to these terminals.
26	RS-485 A		

Term	Function	Technical data	Description
51	GENERATOR CONTACTOR	Relay output, 16A-AC	This output provides energy to the generator contactor. If the generator phases do not have acceptable voltage or frequency values, the generator contactor will be de-energized. In order to provide extra security, the normally closed contact of the mains contactor should be serially connected to this output.
52	GEN-L1	Generator phase inputs, 0-300V-AC	Connect the generator phases to these inputs. The generator phase voltages upper and lower limits are programmable.
54	GEN-L2		
56	GEN-L3		
58	GENERATOR NEUTRAL	Input, 0-300V-AC	Neutral terminal for the generator phases.

Term	Function	Technical data	Description
59	CURR_1+	Current transformer inputs, 5A-AC	Connect the generator current transformer terminals to these inputs. Do not connect the same current transformer to other instruments otherwise a unit fault will occur. Connect each terminal of the transformer to the unit's related terminal. Do not use common terminals. Do not use grounding. Correct polarity of connection is vital. The rating of the transformers should be identical for each of the 3 phases. The secondary winding rating shall be 5 Amperes. (ex: 200/5 Amps).
60	CURR_1-		
61	CURR_2+		
62	CURR_2-		
63	CURR_3+		
64	CURR_3-		

Term	Function	Technical data	Description
65	<b>MAINS NEUTRAL</b>	Input, 0-300V-AC	Neutral terminal for the mains phases.
67	<b>MAINS-L3</b>	Mains phase inputs, 0-300V-AC	Connect the mains phases to these inputs. The mains voltages upper and lower limits are programmable.
69	<b>MAINS-L2</b>		
71	<b>MAINS-L1</b>		
72	<b>MAINS CONTACTOR</b>	Relay output, 16A-AC	This output provides energy to the mains contactor. If the mains phases do not have acceptable voltages, the mains contactor will be de-energized. In order to provide extra security, the normally closed contact of the generator contactor should be serially connected to this output.

## 8. TECHNICAL SPECIFICATIONS

**DC Supply Range:** 9.0 to 33.0 V-DC.

**DC power consumption:**

250 mA-DC typical @12V-DC

125 mA-DC typical @24V-DC

500 mA-DC max. @12V-DC

250 mA-DC max. @24V-DC

**Alternator voltage:** 0 to 330 V-AC (Ph-N), 0 to 570V Ph-Ph

**Alternator frequency:** 0-500 Hz.

**Mains voltage:** 0 to 330 V-AC (Ph-N) , 0 to 570V Ph-Ph

**Mains frequency:** 0-500 Hz.

**Current Inputs:** from current transformers. ..5A.

**CT Range:** 5/5A to 5000/5A

**VT Range:** 0.1/1 to 6500 / 1

**kW Range:** 0.1kW to 65000 kW

**Accuracy:**

**Voltage:** 0.5%+1 digit

**Current:** 0.5%+1 digit

**Frequency:** 0.5%+1 digit

**Power(kW,kVAr):** 1.0%+2digit

**Power factor:** 0.5 %+1digit

**Digital inputs:** input voltage 0 to 36 V-DC.

**Analog input range:** 0-5000 ohms.

**Mains and genset contactor outputs:** 16Amps@250V

**DC Outputs:** Relay outputs, positive switching NO contacts. 10Amps@28V-DC

**Cranking dropouts:** survives 0V for 100ms.

**Magnetic pickup voltage:** 0.5 to 30V-RMS.

**Magnetic pickup frequency:** 10 to 10000 Hz.

**Charge Alternator Excitation:** 100mA @12VDC, 200mA @24VDC

**Ethernet Port:** 10/100 Mbits

**USB Device:** USB 2.0 Full speed

**USB Host:** USB 2.0 Full speed

**RS-485 Port:** selectable baud rate

**RS-232 Port:** selectable baud rate

**Operating temperature:** -20°C to 70°C (-4 to +158 °F).

**Storage temperature:** -40°C to 80°C (-40 to +176°F).

**Maximum humidity:** 95% non-condensing.

**IP Protection:** IP54 from front panel, IP30 from the rear.

**Dimensions:** 200 x 148 x 46mm (WxHxD)

**Panel Cut-out Dimensions:** 176 x 121 mm minimum.

**Weight:** 450 g (approx.)

**Case Material:** High Temperature, non-flammable, ROHS compliant ABS/PC

**Mounting:** Flush mounted with rear retaining plastic brackets.

**EU Directives Conformity**

-2006/95/EC (low voltage)

-2004/108/EC (electro-magnetic compatibility)

**Norms of reference:**

EN 61010 (safety requirements)

EN 61326 (EMC requirements)

**UL Compatibility:** UL 6200, Controls for Stationary Engine Driven Assemblies (Certificate Number - 20140725-E314374)

**CSA Compatibility:** CAN/CSA C22.2 No. 14-2005 – Industrial Control Equipment

## 9. DESCRIPTION OF CONTROLS

### 9.1. FRONT PANEL FUNCTIONALITY

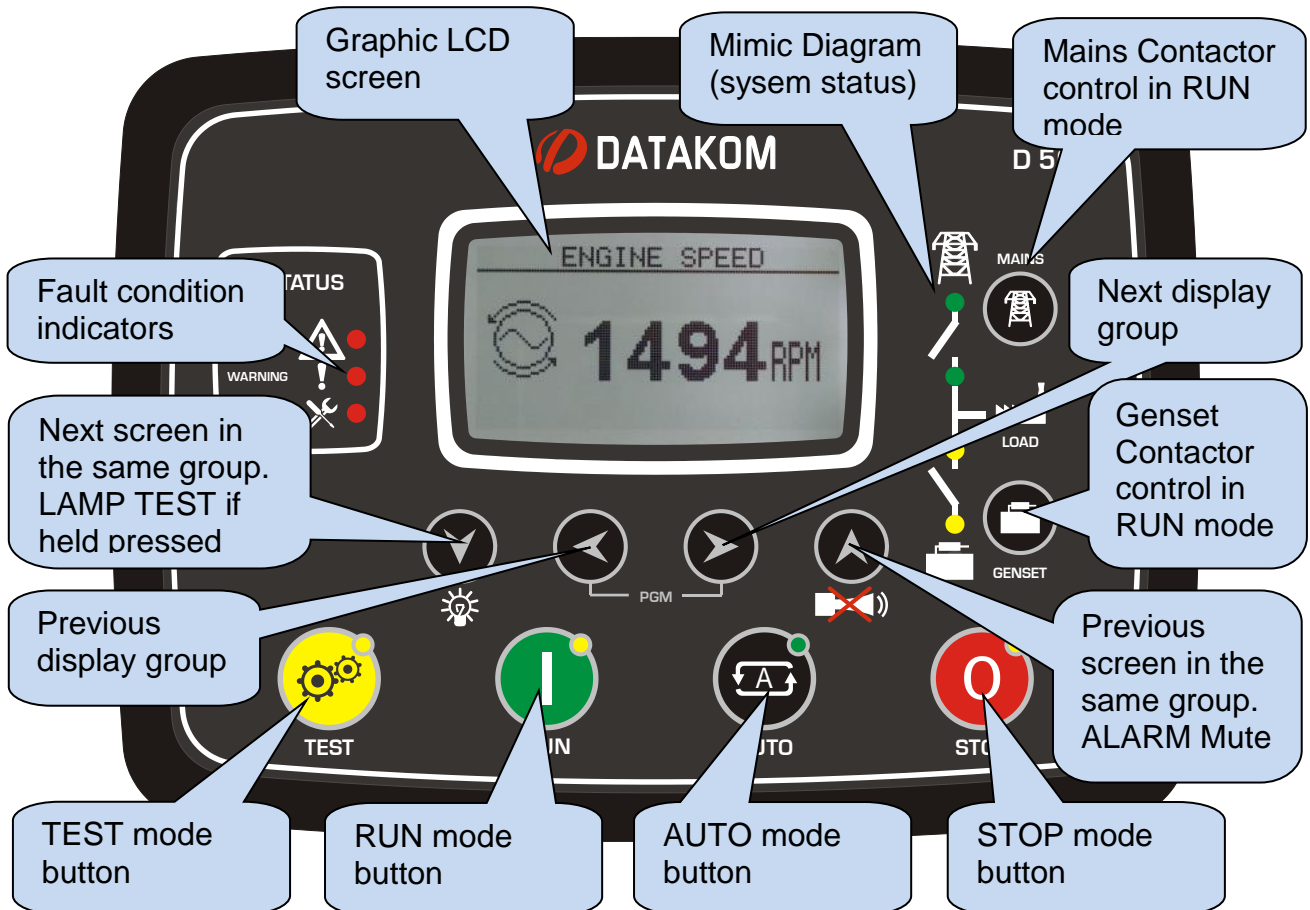













When the engine hours **OR** the time limit is over, the **SERVICE REQUEST** led (red) will start to flash and the service request output function will be active. The service request can also create a fault condition of any level following parameter setting.

The service request output function may be assigned to any digital output using **Relay Definition** program parameters. Also relays on an extension module may be assigned to this function.



**To turn off the SERVICE REQUEST led, and reset the service period, press together the ALARM MUTE and LAMP TEST keys for 5 seconds.**

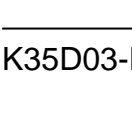

## 9.2. PUSHBUTTON FUNCTIONS

BUTTON	FUNCTION
	Selects TEST mode. The genset runs and takes the load.
	Selects RUN mode. The genset runs off-load.
	Selects AUTO mode. The genset runs when necessary and takes the load.
	Selects OFF mode. The genset stops.
	Selects next display screen in the same display group. LAMP TEST when held pressed.
	Selects previous display group.
	Selects next display group.
	Selects previous display screen in the same display group. Resets the ALARM RELAY.
	Manual MAINS CONTACTOR control in RUN mode.
	Manual GENSET CONTACTOR control in RUN mode.
	When held pressed for 5 seconds, enters PROGRAMMING mode.
	Makes factory reset. Please review chapter RESETTING TO FACTORY DEGAULTS for more details.
	When held pressed for 5 seconds, resets service request counters. Please review chapter SERVICE REQUEST ALARM for more details.





## 9.3. DISPLAY SCREEN ORGANIZATION

The unit measures a large number of electrical and engine parameters. The display of the parameters is organized as PARAMETER GROUPS and items in a group.

Navigation between different groups are made with  and  buttons.

Each depression of the  button will cause the display to switch to the next group of parameters. After the last group the display will switch to the first group.

Each depression of the  button will cause the display to switch to the previous group of parameters. After the first group the display will switch to the last group.

Navigation inside a groups is made with  and  buttons.

Each depression of the  button will cause the display to switch to the next parameter in the same group. After the last parameter the display will switch to the first parameter.

Each depression of the  button will cause the display to switch to the previous parameter in the same group. After the first parameter the display will switch to the last parameter.

Below is a basic list of parameter groups:

**Genset Parameters:** Genset voltages, currents, kW, kVA, kVAr, pf etc...

**Engine Parameters:** Analog sender readings, rpm, battery voltage, engine hours, etc...

**J1939 Parameters:** Opens only if the J1939 port is enabled. The unit is able to display a long list of parameters, under the condition that the engine sends this information. A complete list of available readings is found at chapter J1939 CANBUS ENGINE SUPPORT.

**Mains Parameters:** Mains voltages, currents, kW, kVA, kVAr, pf etc... Mains currents and power parameters are displayed only when CT Selection is made as LOAD SIDE. Otherwise mains current and power related parameters will not be displayed.

**Scopemeter Display:** This group display waveforms of voltages and currents as an oscilloscope. All Ph-N and Ph-Ph voltages as well as phase currents are available. This feature is especially useful to investigate waveform distortions and harmonic loads.

**Graphical Harmonic Analysis Results:** This group displays harmonic composition of voltages and currents. All Ph-N and Ph-Ph voltages as well as phase currents are available. This feature is especially useful to investigate the harmonic caused by complex loads. Only harmonics above 2% are represented in the graphics because of the display resolution. In order to see all harmonic levels please use the Alphanumerical Harmonic Analysis Results.

**Alphanumerical Harmonic Analysis Results:** This group displays harmonic composition of voltages and currents with 0.1% resolution. All Ph-N and Ph-Ph voltages as well as phase currents are available. This feature is especially useful to investigate the harmonic caused by complex loads.

**Alarm Display:** This group displays all existing alarms, one screen per alarm. When there is no more alarm to display it will show "END OF ALARM LIST".

**GSM Modem Parameters:** Signal strength, counters, communication status, IP addresses etc...

**Ethernet Parameters:** Ethernet connection status, counters, IP addresses etc...

**Status & Counters Groups:** This group includes various parameters like genset status, service counters, date-time, firmware version etc...

## 9.4. AUTOMATIC DISPLAY SCROLL

The unit will automatically scroll all Mains, Genset and Engine measurements with programmable interval. The scroll period setting can be performed using the RainbowPlus program through **Module > Screen** options.

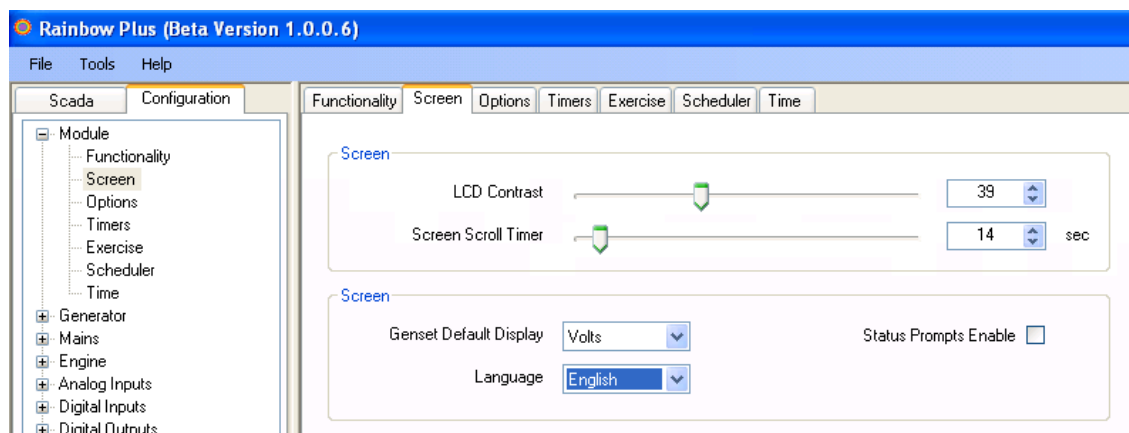

Eventually the same parameter can be modified through the front panel programming menu. The related parameter is Controller **Configuration > Screen Scroll Timer**.



**If the Screen Scroll Timer is set to zero, then scrolling will be disabled.**



**When a front panel button is pressed, the scrolling is suspended during 2 minutes.**



**If a fault condition occurs, the display will automatically switch to the ALARM LIST page.**

## 9.5. MEASURED PARAMETERS

The unit performs a detailed set of AC measurements.

Mains currents and power parameters (listed in blue color) are measured and displayed only if CTs are placed at load side. please see connection diagrams section for more details.

**The list of measured AC parameters is below:**

Mains voltage phase L1 to neutral	Gen voltage phase L1 to neutral
Mains voltage phase L2 to neutral	Gen voltage phase L2 to neutral
Mains voltage phase L3 to neutral	Gen voltage phase L3 to neutral
Mains average voltage phase to neutral	Gen average voltage phase to neutral
Mains voltage phase L1-L2	Gen voltage phase L1-L2
Mains voltage phase L2-L3	Gen voltage phase L2-L3
Mains voltage phase L3-L1	Gen voltage phase L3-L1
Mains frequency	Gen frequency
Mains current phase L1	Gen current phase L1
Mains current phase L2	Gen current phase L2
Mains current phase L3	Gen current phase L3
Mains average current	Gen average current
Mains kW phase L1	Gen kW phase L1
Mains kW phase L2	Gen kW phase L2
Mains kW phase L3	Gen kW phase L3
Mains total kW	Gen total kW
Mains kVA phase L1	Gen kVA phase L1
Mains kVA phase L2	Gen kVA phase L2
Mains kVA phase L3	Gen kVA phase L3
Mains kVA phase L1	Gen kVA phase L1
Mains kVA phase L2	Gen kVA phase L2
Mains kVA phase L3	Gen kVA phase L3
Mains pf phase L1	Gen pf phase L1
Mains pf phase L2	Gen pf phase L2
Mains pf phase L3	Gen pf phase L3
Mains total pf	Gen total pf
Mains neutral current	Gen Neutral current

**Below engine parameters are always measured:**

Engine speed (rpm)  
Battery voltage,

The unit features 4 analog senders, fully configurable for the name and function.

**Below is a typical list of analog senders, capable of changing following configuration:**

Coolant temperature  
Oil pressure (bar, kPa)  
Fuel level (% , lt)  
Oil temperature (°C, °F)



**Items in blue are measured only when current transformers are at the load side.**

## 9.6. LED LAMPS

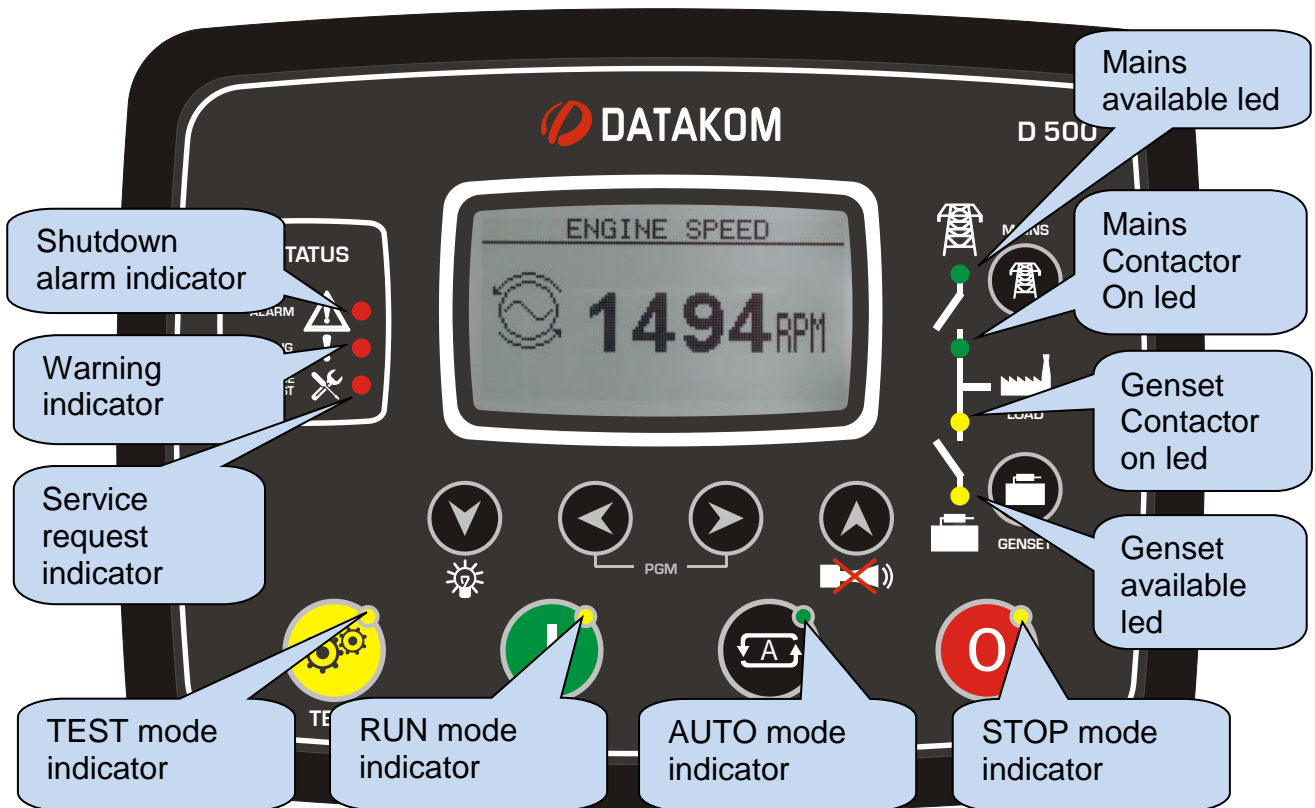

### **STATUS LEDS:**

**ALARM:** Turns on when a shutdown alarm or loaddump condition exists.

**WARNING:** Turns on when a warning condition exists

**SERVICE REQUEST:** Turns on when at least one of the service counters has expired.

**MODE LEDS:** Each led turns on when the related mode is selected, either locally or remotely.

### **MIMIC DIAGRAM LEDS:**

**MAINS AVAILABLE:** This led turns on when all mains phase voltages and the mains frequency are within limits. If enabled, the mains phase rotation order must be also right. When any digital input is defined as Remote Start, this led will reflect the status of the input. When a Simulate Mains signal is present, then mains status will become "available". When a Force to Start signal is present, then the mains status will become "not available".

**MAINS CONTACTOR ON:** Turns on when the mains contactor is activated.

**GENSET CONTACTOR ON:** Turns on when the genset contactor is activated.

**GENSET AVAILABLE:** This led turns on when all genset phase voltages and the genset frequency are within limits. If enabled, the genset phase rotation order must be also right.



If a **Remote Start** input is defined, then the Mains led will reflect the input status.

**Simulate Mains** and **Force to Start** signals will also affect this led.

## 10. WAVEFORM DISPLAY & HARMONIC ANALYSIS

The unit features waveform display together with a precision harmonic analyzer for both mains and genset voltages and currents. Both phase to neutral and phase to phase voltages are available for analysis, thus 18 channels in total are possible.



**In order to enable display and analysis of mains currents, current transformers must be placed at load side.**

### Available channels are:

Mains volts: V1, V2, V3, U12, U23, U31

Mains currents: I1, I2, I3

Genset volts: V1, V2, V3, U12, U23, U31

Genset currents: I1, I2, I3

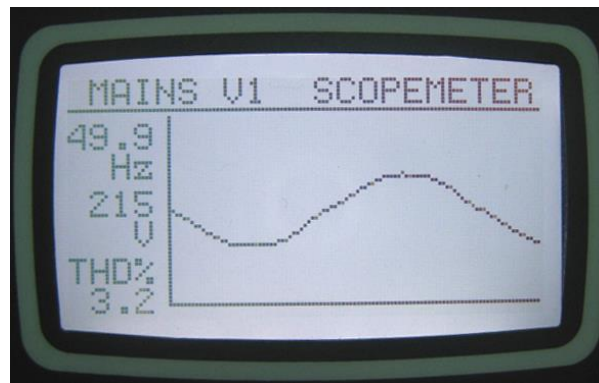



*Scopemeter Display*

The waveform display memory is of 100 samples length and 13 bit resolution, with a sampling rate of 4096 s/s. Thus one cycle of a 50Hz signal is represented with 82 points. The vertical scale is automatically adjusted in order to avoid clipping of the signal.

The waveform is displayed on the device screen, and with more resolution on PC screen through the RainbowPlus program.

The display memory is also available in the Modbus register area for third party applications. For more details please check chapter "**MODBUS Communications**".

The waveform display is updated twice a second. All channels may be scrolled using   buttons.

The harmonic analyzer consists on a Fast Fourier Transform (FFT) algorithm which is run twice a second on the selected channel.

The sample memory is 1024 samples length and 13 bits resolution with a sampling rate of 4096 s/s.

The theory says that a periodic signal may have only odd multiples of the main frequency. Thus in a 50Hz network, harmonics will be found only at 150, 250, 350, 450 Hz etc...

The unit is able to analyze up to 1800Hz and up to 31th harmonic, whichever is smaller. Thus in a 50Hz system all 31 harmonics will be displayed, but in a 60Hz system only 29 harmonics will come to the screen.

In case of a 400Hz system, only the 3<sup>rd</sup> harmonic will be displayed.



Graphical Harmonic Table



Alphanumeric Harmonics Table

Harmonic are represented by 2 different ways on the device display. The first one is a graphical representation allowing one sight perception of the harmonic structure. Because of the display resolution, only harmonics above 2% are displayed.

The second display is alphanumeric, thus all harmonics are displayed with 0.1% resolution in order to provide more detailed information.

On RainbowPlus program, harmonics and waveform are displayed on a single screen with more resolution.

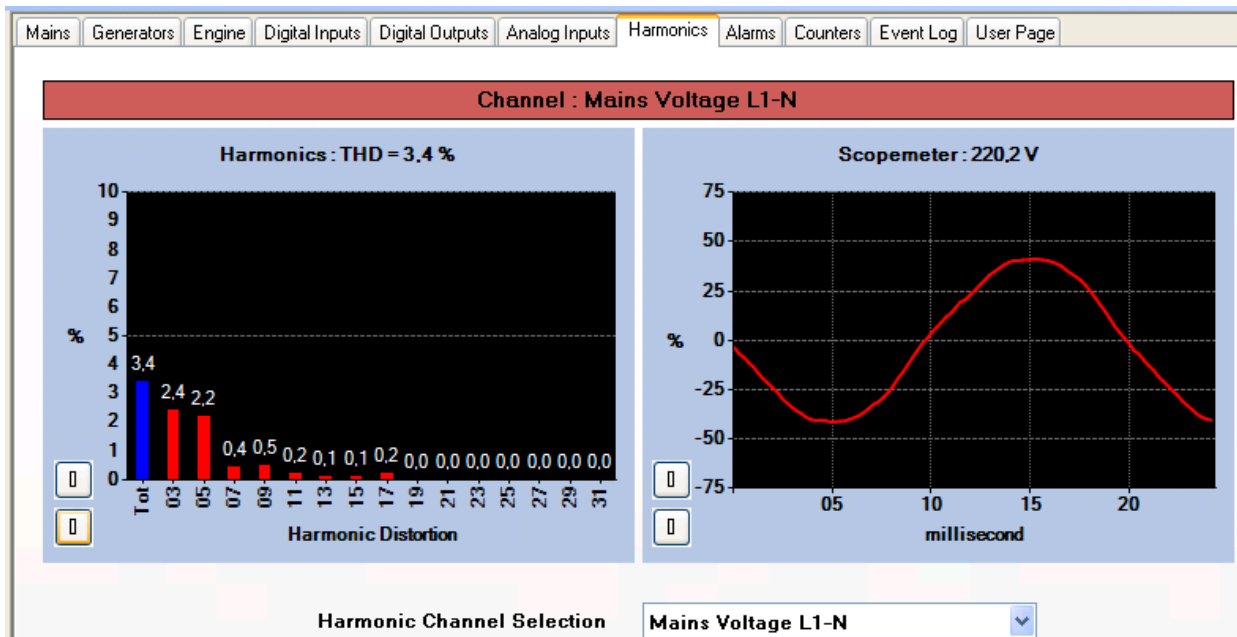

RainbowPlus Scada section: Harmonic Analysis and Waveform Display

## 11. DISPLAYING EVENT LOGS

The unit features more than 400 event logs with date-time stamp and full snapshot of measured values at the moment that the event has occurred.

### Stored values in an event record are listed below:

- event number
- event type / fault definition (see below for various event sources)
- date and time
- operation mode
- operation status (on-load, on-mains, cranking, etc...)
- engine hours run
- mains phase voltages: L1-L2-L3
- mains frequency
- genset phase voltages: L1-L2-L3
- genset phase currents: L1-L2-L3
- genset frequency
- genset total active power (kW)
- genset total power factor
- oil pressure
- engine temperature
- fuel level
- oil temperature
- canopy temperature
- ambient temperature
- engine rpm
- battery voltage
- charge voltage

Possible event sources are various. Every source can be individually enabled or disabled:

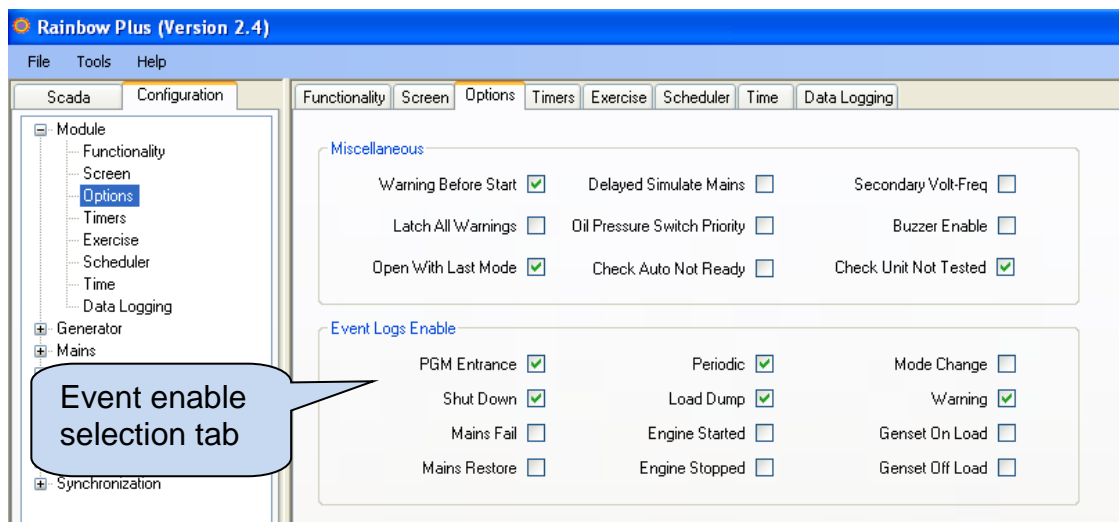

**Program mode entrance event:** recorded with the password level when program mode is entered.

**Periodic event:** recorded every 30 minutes when the engine is running, and every 60 minutes anyway.

**Mode change event:** recorded when the operation mode is changed.

**Shutdown/loaddump/warning events:** recorded when the related fault condition occurs.



**Mains fail/restore events:** recorded when mains status is changed

**Engine started/stopped events:** recorded when engine status is changed

**Genset on load/off load events:** recorded when the genset loading status is changed



Event logs are displayed within the program mode menu. This is designed in order to reduce the interference of event logs with other measurement screens.

To **enter the event display**, press together  and  buttons for 5 seconds.

When the program mode is entered, below password entry screen will be displayed.







Skip the password entry screen by pressing the  button 4 times. The screen below left will come.

Press again the  button. The last stored event will open, as in the below-right picture.

The first page will display the event number, event type, fault type and date-time information.



When displaying event logs:

-  button will display the next information in the same event
-  button will display the previous information in the same event
-  button will display the same information of the previous event
-  button will display the same information of the next event.



## 12. STATISTICAL COUNTERS

The unit provides a set of non-resettable incremental counters for statistical purposes.

The counters consist on:

- total genset kWh
- total genset kVArh inductive
- total genset kVArh capacitive
- total genset export kWh
  
- total mains kWh
- total mains kVArh
- total mains kVAh
  
- total engine hours
- total engine starts
- total fuel filled in the tank
  
- engine hours to service-1
- time to service-1
- engine hours to service-2
- time to service-2
- engine hours to service-3
- time to service-3

These counters are kept in a non-volatile memory and are not affected from power failures.

### 12.1. FUEL FILLING COUNTER

The unit offers a temper-proof incremental counter for fuel filling.

Related parameters are:

Parameter Definition	Unit	Min	Max	Required value	Description
Fuel Pulses from MPU input	-	0	1	1	<b>0:</b> MPU input is used for engine speed detection <b>1:</b> MPU input is used for reading the flowmeter pulses during fuel filling.
Fuel Pulses per Volume	-	0	65000	any	This is the number of pulses produced by the flowmeter for the unit volume. This parameter is characteristic of the flowmeter used and should be set according to the flowmeter data.
Fuel Counter Unit	Lt/gal	-	-	any	This is the unit for the fuel counter
Fuel Counter Type	-	0	1	0	This parameter determines the purpose of fuel pulses <b>0:</b> Fuel filling pulses, increment fuel counter <b>1:</b> Fuel consumption pulses, display consumption.

The quantity of the fuel filled in the tank is read from pulses generated by a flowmeter installed at the tank filling hose. Flowmeter pulse outputs will be connected to the MPU input of the controller. The controller will count pulses and convert them in liters (or gallons) then increment the fuel filling counter by the calculated amount.

The fuel filling counter is visible through Scada and Central Monitoring. Thus the genset operator can confirm fuel invoices with the real amount of fuel filled in the tank, preventing corruption.

## 12.2. FUEL CONSUMPTION MONITORING

The unit is capable to display the actual fuel consumption of the engine by two different ways:

- Through J1939 fuel consumption information
- By counting fuel consumption pulses.

If the engine is sending the fuel rate through J1939 messaging, then the unit will directly display the fuel consumption information coming from the ECU.

If a flowmeter is installed at the fuel suction hose of the engine, then the unit is also capable of counting these pulses, calculating and displaying the fuel consumption.

Related parameters are:

Parameter Definition	Unit	Min	Max	Required Value	Description
Fuel Pulses from MPU input	-	0	1	1	<b>0:</b> MPU input is used for engine speed detection <b>1:</b> MPU input is used for reading the flowmeter pulses during fuel filling.
Fuel Pulses per Volume	-	0	65000	any	This is the number of pulses produced by the flowmeter for the unit volume. This parameter is characteristic of the flowmeter used and should be set according to the flowmeter data.
Fuel Counter Unit	Lt/gal	-	-	any	This is the unit for the fuel counter
Fuel Counter Type	-	0	1	1	This parameter determines the purpose of fuel pulses <b>0:</b> Fuel filling pulses, increment fuel counter <b>1:</b> Fuel consumption pulses, display consumption.

## 13. OPERATION OF THE UNIT

### 13.1. QUICK START GUIDE

**STOPPING THE ENGINE:** Press STOP  button

**STARTING THE ENGINE:** Press RUN  button

**MANUAL LOAD TRANSFER:** Use MAINS  and GENSET  buttons.

**LOAD TEST:** Press TEST  button. The genset will run and take the load.

**AUTOMATIC OPERATION:** Press AUTO  button. Check that **AUTO READY** led is illuminated.



**Mode can be changed anytime without negative effect. Changing the operation mode while the genset is running will result into a behavior suitable for the new operating mode.**

### 13.2. STOP MODE

The STOP mode is entered by pressing the  button.

In this mode, the genset will be in a rest state.

When STOP mode is selected, if the genset is running under load, then it will be immediately unloaded. The engine will continue to run during **Cooldown Timer** and will stop afterwards.

If the STOP button is pressed again, then the engine will immediately stop.

If the engine fails to stop after the expiration of **Stop Timer** then a **Fail to Stop** warning will occur.

In this mode, the mains contactor will be energized only if mains phase voltages and frequency are within the programmed limits. If enabled, the mains phase order is also checked.

If a **Remote Start** or **Force to Start** signal arrives in STOP mode, the genset will not start until AUTO mode is selected.

### 13.3. AUTO MODE

The AUTO mode is entered by pressing the  button.

The AUTO mode is used for the automatic transfer between genset and mains. The controller will constantly monitor the mains availability. It will run the engine and transfer the load when a mains failure occurs.



**If a panel lock input is defined and signal is applied, then mode change will not occur. However display navigation buttons are still enabled and parameters may be visualized.**

#### The mains availability evaluation sequence is below:

- If at least one of the mains phase voltages or the mains frequency is outside limits, the mains will be supposed failing. Otherwise mains is available.
- If a Simulate Mains signal is present, then mains are made available
- If a Force to Start signal is present, then mains are unavailable
- If a Remote Start input is defined, then this signal decides of mains availability.

#### When mains are evaluated as “unavailable” then an engine start sequence begins:

- The unit waits during Engine Start Delay for skipping short mains failures. If the mains is restored before the end of this timer, the genset will not start.
- The unit turns on the fuel and preheat glow plugs (if any) and waits for preheat timer.
- The engine will be cranked for programmed times during crank timer. When the engine fires, the crank relay will be immediately deactivated. See section **Crank Cutting** for more details.
- The engine will run at idle speed during Idle Speed Timer.
- The engine will run unloaded during engine heating timer.
- If alternator phase voltages, frequency and phase order are correct, the unit will wait for the generator contactor period and the generator contactor will be energized.

#### When mains are evaluated as “available” again then an engine stop sequence begins:

- The engine will continue to run for the mains waiting period to allow mains voltages to stabilize.
- Then the generator contactor is deactivated and the mains contactor will be energized after mains contactor timer.
- If a cooldown period is given, the generator will continue to run during the cooldown period.
- Before the end of cooldown, the unit will reduce the engine speed to idle speed.
- At the end of cooldown, the fuel solenoid will be de-energized, the stop solenoid will be energized for Stop Solenoid timer and the diesel will stop.
- The unit will be ready for the next mains failure.



**If the operation of the genset is disabled by the weekly schedule, then the AUTO led will flash, and the operation of the genset will be as in the OFF mode.**



## 13.4. RUN MODE, MANUAL CONTROL

The RUN mode is entered by pressing the  button.

When the RUN mode is selected, the engine will be started regardless of the mains availability.

### **The starting sequence is as described below:**

- The unit turns on the fuel and preheat glow plugs (if any) and waits for preheat timer.
- The engine will be cranked for programmed times during crank timer. When the engine fires, the crank relay will be immediately deactivated. See section **Crank Cutting** for more details.
- The engine will run at idle speed during Idle Speed Timer.
- The engine will run unloaded until another mode is selected..

The RUN mode allows also manual contactor control through MC  and GC  buttons.

When a contactor button is pressed, the related contactor will change position. Thus if it was on, then it will turn off. If it was off then it will turn on.

If the other contactor was on, then it will turn off, the controller will wait for the related contactor timer and the contactor will turn on. This will prevent manual closure of both contactors.



**If uninterrupted transfers are allowed, then the unit will check the synchronization. If synchronization is complete, then it will make an uninterrupted transfer, where both contactors will be on for a short while.**



**If Emergency Backup mode is enabled and if the mains are off, then the mains contactor will be deactivated and the generator contactor will be activated.**

**When the mains are on again, a reverse changeover to the mains will be performed, but the engine will keep running unless another mode is selected.**

In order to stop the engine press  button or select another mode of operation.

## 13.5. TEST MODE

The TEST mode is entered by pressing the  button.

The TEST mode is used in order to test the genset under load.

Once this mode is selected, the engine will run as described in the AUTO mode, regardless of the mains availability and the load will be transferred to the genset.

The genset will feed the load indefinitely unless another mode is selected.

## 14. PROTECTIONS AND ALARMS

The unit provides 3 different protection levels, being warnings, loaddumps and shutdown alarms.

- 1- **SHUTDOWN ALARMS:** These are the most important fault conditions and cause:
  - The **ALARM** led to turn on steadily,
  - The genset contactor to be released immediately,
  - The engine to be stopped immediately,
  - The **Alarm** digital output to operate.
- 2- **LOAD\_DUMPS:** These fault conditions come from electrical trips and cause:
  - The **ALARM** led to turn on steadily,
  - The genset contactor to be released immediately,
  - The engine to be stopped after Cooldown period,
  - The **Alarm** digital output to operate.
- 3- **WARNINGS:** These conditions cause:
  - The **WARNING** led to turn on steadily,
  - The **Alarm** digital output to operate.



**If a fault condition occurs, the display will automatically switch to the ALARM LIST page.**

### Alarms operate in a first occurring basis:

- If a shutdown alarm is present, following shutdown alarms, loaddumps and warnings will not be accepted,
- If a loaddump is present, following loaddumps and warnings will not be accepted,
- If a warning is present, following warnings will not be accepted.



**If the ALARM MUTE button is pressed, the Alarm output will be deactivated; however the existing alarms will persist and disable the operation of the genset.**

Alarms may be of **LATCHING** type following programming.

For latching alarms, even if the alarm condition is removed, the alarms will stay on and disable the operation of the genset.



**Existing alarms may be canceled by pressing one of the operating mode buttons:**



Most of the alarms have programmable trip levels. See the programming chapter for adjustable alarm limits.

## 14.1. DISABLING ALL PROTECTIONS

The unit allows any digital input to be configured as “**Disable Protections**”.

This input configuration is used in cases where the engine is required to run until destruction. This may be the case under critical conditions like firefighting or other emergency cases.

This input should be configured as a “Warning”. Thus when protections are disabled, a warning message will immediately appear on the screen.

When protections are disabled, all shutdown alarms and loaddumps will become warnings. They will appear on the screen, but will not affect genset operation.

The input may be constantly activated, or preferably it may be activated by an external key activated switch in order to prevent unauthorized activation.



**Disabling protections will allow the genset run until destruction. Place written warnings about this situation in the genset room.**

## 14.2. SERVICE REQUEST ALARM

The SERVICE REQUEST led is designed to help the periodic maintenance of the genset to be made consistently.

The periodic maintenance is basically carried out after a given engine hours (for example 200 hours), but even if this amount of engine hours is not fulfilled, it is performed after a given time limit (for example 12 months).

The unit offers 3 independent service counter sets in order to enable different service periods with different priorities.

The fault level created upon expiration of service timers may be set as Warning, Loaddump or Shutdown. Thus different levels of fault conditions may be generated at different overrun levels.

Each service counter set has both programmable engine hours and maintenance time limit. If any of the programmed values is zero, this means that the parameter will not be used. For example a maintenance period of 0 months indicates that the unit will request maintenance only based on engine hours, there will be no time limit. If the engine hours is also selected as 0 hours this will mean that this service counter set is not operative.

When the engine hours **OR** the time limit is over, the **SERVICE REQUEST** led (red) will start to flash and the service request output function will be active. The service request can also create a fault condition of any level following parameter setting.

The service request output function may be assigned to any digital output using **Relay Definition** program parameters. Also relays on an extension module may be assigned to this function.



**To turn off the SERVICE REQUEST led, and reset the service period, press together the ALARM MUTE and LAMP TEST keys for 5 seconds.**

The remaining engine hours and the remaining time limits are kept stored in a non-volatile memory and are not affected from power supply failures.



The time and engine hours to service are displayed in the **GENSET STATUS** menu group.

### 14.3. SHUTDOWN ALARMS



Digital input and analog sender alarms are fully programmable for the alarm name, sampling and action.

Only internal alarms are explained in this section.

<b>GENSET LOW / HIGH FREQUENCY</b>	Set if the generator frequency is outside programmed limits. These faults will be monitored with <b>Fault Holdoff Timer</b> delay after the engine is running. Low and high limits are separately programmable. The detection delay is also programmable. Another high frequency shutdown limit which is 12% above the high limit is always monitored and stops the engine immediately.
<b>GENSET LOW / HIGH RPM</b>	Set if the generator rpm is outside programmed limits. These faults will be monitored with <b>Fault Holdoff Timer</b> delay after the engine is running. Low and high limits are separately programmable. The detection delay is also programmable. The high rpm overshoot limit is always monitored and stops the engine immediately.
<b>GENSET LOW / HIGH VOLTAGE</b>	Set if any of the generator phase voltages goes outside programmed limits for <b>Voltage Fail Timer</b> . This fault will be monitored with <b>Fault Holdoff Timer</b> delay after the engine is running.
<b>LOW / HIGH BATTERY VOLTAGE</b>	Set if the genset battery voltage is outside programmed limits. Low and high limits are separately programmable. The detection delay is also programmable.
<b>FAIL TO START</b>	Set if the engine is not running after programmed number of start attempts.
<b>LOW CHARGE VOLTAGE</b>	Set if the charge alternator voltage is below the programmed limit. This fault will be monitored with <b>Fault Holdoff Timer</b> delay after the engine is running.
<b>J1939 ECU FAIL</b>	Set if no information has been received during 3 seconds from the ECU of the electronic engine. This fault condition is only controlled when fuel is on.
<b>VOLTAGE UNBALANCE</b>	Set if any of the generator phase voltages differs from the average by more than <b>Voltage Unbalance Limit</b> for <b>Voltage Fail Timer</b> . This fault will be monitored with <b>Fault Holdoff Timer</b> delay after the engine is running.
<b>CURRENT UNBALANCE</b>	Set if any of the generator phase currents differs from the average by more than <b>Voltage Unbalance Limit</b> for <b>Voltage Fail Timer</b> . This fault will be monitored with <b>Fault Holdoff Timer</b> delay after the engine is running. The action taken at fault condition is programmable.
<b>OVERCURRENT</b>	Set if at least one of the genset phase currents goes over the <b>Overcurrent Limit</b> for the period allowed by the IDMT curve setting. The allowed timer is dependent of the overcurrent level. If currents go below the limit before expiration of the timer then no alarm will be set. Please check chapter Overcurrent Protection (IDMT) for more details. The action taken at fault condition is programmable.
<b>PICKUP SIGNAL LOST</b>	Set if the rpm measured from the magnetic pickup input falls below the <b>Crank Cut RPM</b> level during <b>Loss of Speed Signal Timer</b> . The action of signal loss is programmable.
<b>SERVICE REQUEST</b>	Set if at least one of the service counters has expired. In order to reset the service counters please hold pressed both  and  buttons during 5 seconds. The screen will display "Completed!"





## 14.4. LOADDUMP ALARMS



Digital input and analog sender alarms are fully programmable for the alarm name, sampling and action.

Only internal alarms are explained in this section.

<b>VOLTAGE UNBALANCE</b>	Set if any of the generator phase voltages differs from the average by more than <b>Voltage Unbalance Limit</b> for <b>Voltage Fail Timer</b> . This fault will be monitored with <b>Fault Holdoff Timer</b> delay after the engine is running.
<b>CURRENT UNBALANCE</b>	Set if any of the generator phase currents differs from the average by more than <b>Voltage Unbalance Limit</b> for <b>Voltage Fail Timer</b> . This fault will be monitored with <b>Fault Holdoff Timer</b> delay after the engine is running. The action taken at fault condition is programmable.
<b>OVERCURRENT</b>	Set if at least one of the genset phase currents goes over the <b>Overcurrent Limit</b> for the period allowed by the IDMT curve setting. The allowed timer is dependent of the overcurrent level. If currents go below the limit before expiration of the timer then no alarm will be set. Please check chapter Overcurrent Protection (IDMT) for more details. The action taken at fault condition is programmable.
<b>OVERLOAD</b>	Set if the genset power (kW) supplied to the load goes over the <b>Overload Load Dump</b> limit for <b>Overload Timer</b> . If the power goes below the limit before expiration of the timer then no alarm will be set.
<b>REVERSE POWER</b>	Set if the genset power (kW) is negative and goes over the <b>Reverse Power</b> limit for <b>Reverse Power Timer</b> . If the power goes below the limit before expiration of the timer then no alarm will be set.
<b>GENSET PHASE ORDER FAIL</b>	Set if the fault is enabled and the genset phase order is reverse.
<b>MAINS CB FAIL TO OPEN</b>	Set if the feedback input is defined and the related contactor block feedback signal is not detected after the expiration of Contactor Open/Close Fail Timer.
<b>GENSET CB FAIL TO CLOSE</b>	Set if the feedback input is defined and the related contactor block feedback signal is not detected after the expiration of Contactor Open/Close Fail Timer.
<b>PICKUP SIGNAL LOST</b>	Set if the rpm measured from the magnetic pickup input falls below the <b>Crank Cut RPM</b> level during <b>Loss of Speed Signal Timer</b> . The action of signal loss is programmable.
<b>SERVICE REQUEST</b>	Set if at least one of the service counters has expired. In order to reset the service counters please hold pressed both  and  buttons during 5 seconds. The screen will display "Completed!"
<b>UNIT LOCKED</b>	Set if the controller is remotely locked.
<b>UNKNOWN TOPOLOGY</b>	Set if the automatic topology determination is active, and the topology cannot be determined during "Holdoff timer" after the engine runs.



## 14.5. WARNINGS

 Digital input and analog sender alarms are fully programmable for the alarm name, sampling and action. Only internal alarms are explained in this section.

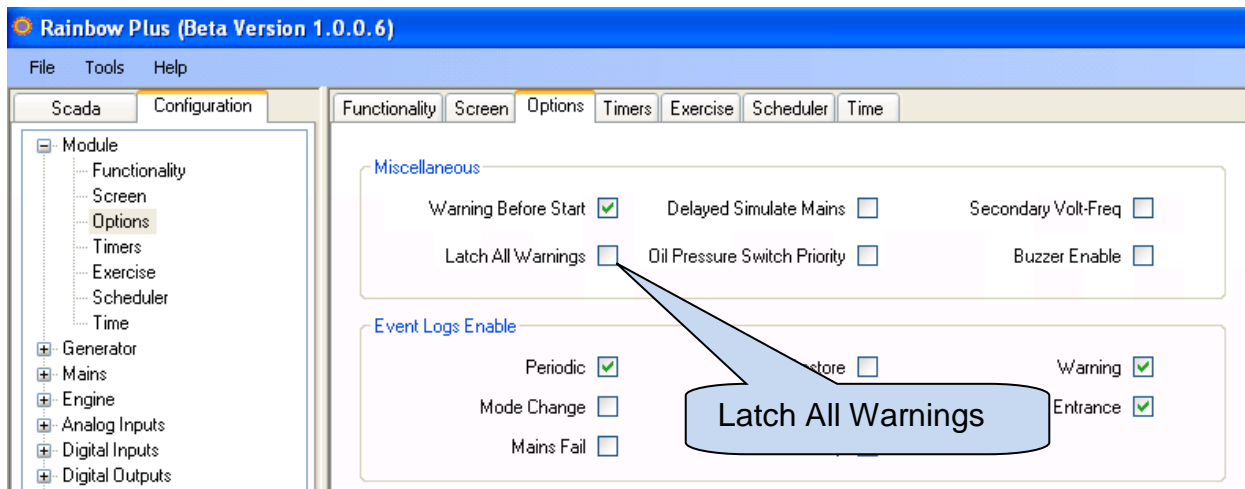
 All warnings can be made latching by enabling a single program parameter: **Controller Configuration > Latch All Warnings**



<b>GENSET LOW / HIGH FREQUENCY</b>	Set if the generator frequency is outside programmed limits. These faults will be monitored with <b>Fault Holdoff Timer</b> delay after the engine is running. Low and high limits are separately programmable. The detection delay is also programmable. Another high frequency shutdown limit which is 12% above the high limit is always monitored and stops the engine immediately.
<b>GENSET LOW / HIGH RPM</b>	Set if the generator rpm is outside programmed limits. These faults will be monitored with <b>Fault Holdoff Timer</b> delay after the engine is running. Low and high limits are separately programmable. The detection delay is also programmable. The high rpm overshoot limit is always monitored and stops the engine immediately.
<b>GENSET LOW / HIGH VOLTAGE</b>	Set if any of the generator phase voltages goes outside programmed limits for <b>Voltage Fail Timer</b> . This fault will be monitored with <b>Fault Holdoff Timer</b> delay after the engine is running.
<b>LOW / HIGH BATTERY VOLTAGE</b>	Set if the genset battery voltage is outside programmed limits. Low and high limits are separately programmable. The detection delay is also programmable.
<b>FAIL TO STOP</b>	Set if the engine has not stopped before the expiration of the <b>Stop Timer</b> .
<b>LOW CHARGE VOLTAGE</b>	Set if the charge alternator voltage is below the programmed limit. This fault will be monitored with <b>Fault Holdoff Timer</b> delay after the engine is running.

<b>J1939 ECU FAIL</b>	Set when an engine fault code is received from the ECU of the electronic engine. This fault will not cause an engine stop. If necessary, the engine will be stopped by the ECU.
<b>VOLTAGE UNBALANCE</b>	Set if any of the generator phase voltages differs from the average by more than <b>Voltage Unbalance Limit</b> for <b>Voltage Fail Timer</b> . This fault will be monitored with <b>Fault Holdoff Timer</b> delay after the engine is running.
<b>CURRENT UNBALANCE</b>	Set if any of the generator phase currents differs from the average by more than <b>Voltage Unbalance Limit</b> for <b>Voltage Fail Timer</b> . This fault will be monitored with <b>Fault Holdoff Timer</b> delay after the engine is running. The action taken at fault condition is programmable.
<b>OVERCURRENT</b>	Set if at least one of the genset phase currents goes over the <b>Overcurrent Limit</b> for the period allowed by the IDMT curve setting. The allowed timer is dependent of the overcurrent level. If currents go below the limit before expiration of the timer then no alarm will be set. Please check chapter Overcurrent Protection (IDMT) for more details. The action taken at fault condition is programmable.
<b>OVERCURRENT</b>	Set if at least one of the genset phase currents goes over the <b>Overcurrent Limit</b> .
<b>REVERSE POWER</b>	Set if the genset power (kW) is negative and goes over the <b>Reverse Power</b> limit for <b>Reverse Power Timer</b> . If the power goes below the limit before expiration of the timer then no alarm will be set.
<b>MAINS PHASE ORDER FAIL</b>	Set if the mains phase order checking is enabled, mains phases are present and mains phase order is reversed. This fault prevents the Mains Contactor to close.
<b>GENSET CB FAIL TO CLOSE / OPEN</b>	Set if the feedback input is defined and the related contactor block feedback signal is not detected after the expiration of Contactor Open/Close Fail Timer.
<b>MAINS CB FAIL TO CLOSE</b>	Set if the feedback input is defined and the related contactor block feedback signal is not detected after the expiration of Contactor Open/Close Fail Timer.
<b>PICKUP SIGNAL LOST</b>	Set if the rpm measured from the magnetic pickup input falls below the <b>Crank Cut RPM</b> level during <b>Loss of Speed Signal Timer</b> . The action of signal loss is programmable.
<b>SERVICE REQUEST</b>	Set if at least one of the service counters has expired. In order to reset the service counters please hold pressed both  and  buttons during 5 seconds. The screen will display "Completed!"
<b>EEPROM WRITE FAULT</b>	Set if the internal non-volatile memory cannot be written.
<b>ENGINE RUNNING</b>	Set if the engine is running while the fuel output is not energized.
<b>AUTO NOT READY</b>	Set if the genset is not in AUTO mode or a fault condition or the weekly schedule prevents the automatic starting of the genset.
<b>GPS DISCONNECTED</b>	Set if the serial communication with the GPS is lost.
<b>GPS SIGNAL LOST</b>	Set if the communication with the GPS module is functional, but the GPS signal level is insufficient to determine the geo-location.

## 14.6. NON-VISUAL WARNINGS



These warnings are not announced at the device front panel, however they appear in event logs, transferred to the Scada and cause SMS and e-mail sending.

<b>FUEL THEFT</b>	<p><b>Engine is not running:</b> If the fuel level measured from the sender input falls by 20% or more in one hour, then <b>Fuel Theft</b> warning occurs (the detection delay is 10 sec, not adjustable).</p> <p><b>Engine is running:</b> If the fuel level measured from the sender input falls by 2x"hourly fuel consumption percentage" or more, then <b>Fuel Theft</b> warning occurs.</p>
<b>FUEL FILLING</b>	If the fuel level measured from the sender input is increased by 20% or more in one hour, then <b>Fuel Filling</b> non-visual warning occurs (the detection delay is 10 seconds, not adjustable).
<b>MAINTENANCE DONE</b>	Sent when the periodic maintenance counters are manually reset.

## 15. PROGRAMMING

### 15.1. RESETTING TO FACTORY DEFAULTS

In order to resume to the factory set parameter values:

- hold pressed the **STOP**, **LAMP TEST** and **ALARM MUTE** buttons for 5 seconds,
- “**RETURN TO FACTORY SET**” will be displayed
- immediately press and hold pressed **RIGHT ARROW** button for 5 seconds
- factory set values will be reprogrammed to the parameter memory.



Hold pressed **STOP**, **LAMP TEST** and **ALARM MUTE**



Hold pressed **RIGHT ARROW**



The program mode is used to adjust timers, operational limits and the configuration of the unit.

Although a free PC program is provided for programming, every parameter may be modified through the front panel, regardless of the operating mode.

When modified, program parameters are automatically recorded into a non-erasable memory and take effect immediately.

The program mode will not affect the operation of the unit. Thus programs may be modified anytime, even while the genset is running.





## 15.2. ENTERING THE PROGRAMMING MODE

To enter the program mode, press together   buttons for 5 seconds.

When the program mode is entered, below password entry screen will be displayed.



A 4 digit password must be entered using     buttons.

The   buttons modify the value of the current digit. The   buttons navigate between digits.

The unit supports 3 password levels. The level\_1 is designed for field adjustable parameters. The level\_2 is designed for factory adjustable parameters. The level\_3 is reserved. It allows recalibration of the unit.

The password level-1 is factory set to '1234' and the password level-2 is factory set to '9876'.



**Passwords are not front panel adjustable.**

If a wrong password is entered, the unit will still allow access to the program parameters, but in read-only mode.

If password "0000" is entered, only EVENT LOG file will be available.



### 15.3. NAVIGATING BETWEEN MENUS

The program mode is driven with a two level menu system. The top menu consists on program groups and each group consists on various program parameters.

When program mode is entered, a list of available groups will be displayed. Navigation between different groups are made with **▲** **▼** buttons. Selected group is shown in reverse video (blue on white). In order to enter inside a group, please press **▶** button. In order to exit from the group to the main list please press **◀** button.



Navigation inside a group is made also with **▲** **▼** buttons. A list of available parameters will be displayed. Selected parameter is shown in reverse video (blue on white). In order display/change the value of this parameter, please press **▶** button. Parameter value may be increased and decreased with **▲** **▼** buttons. If these keys are hold pressed, the program value will be increased/decreased by steps of 10. When a program parameter is modified, it is automatically saved in memory. If **▶** button is pressed, next parameter will be displayed. If **◀** button is pressed, then the list of parameters in this group will be displayed.



### 15.4. MODIFYING PARAMETER VALUE

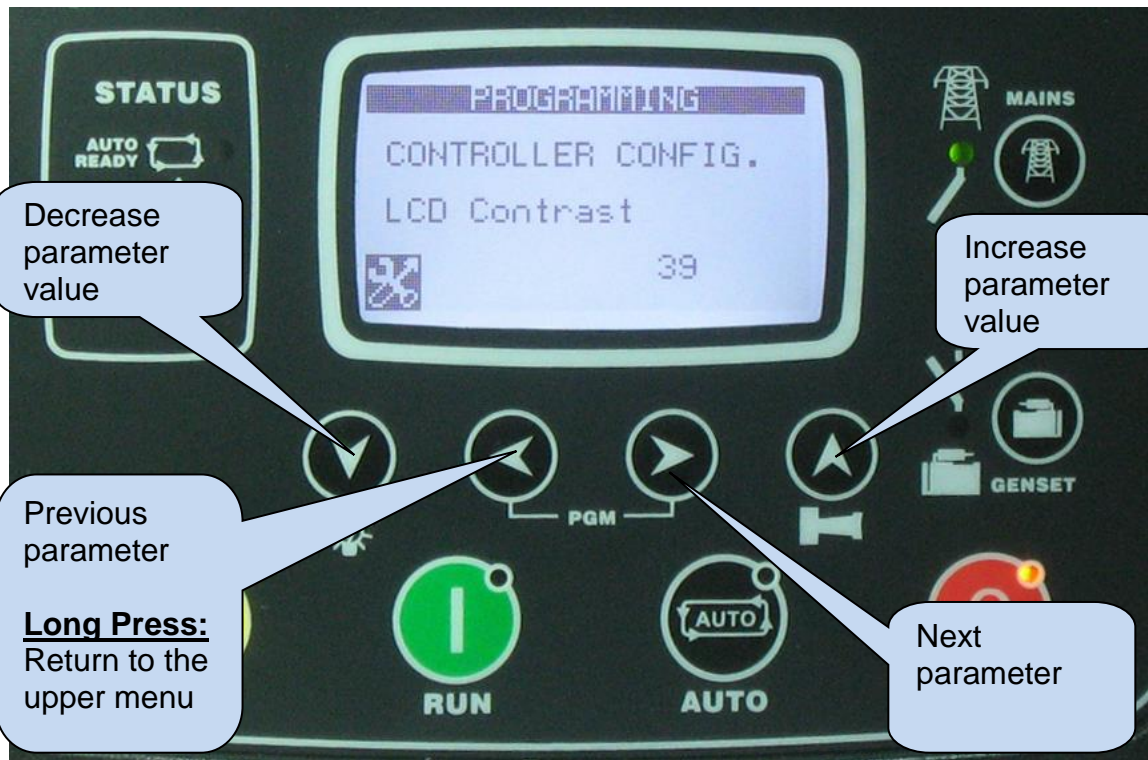



## 15.5. PROGRAMMING MODE EXIT

To **exit the program mode** press one of the mode selection keys. If no button is pressed during 2 minutes the program mode will be cancelled automatically.



## 16. PROGRAM PARAMETER LIST

### 16.1. CONTROLLER CONFIGURATION GROUP

Parameter Definition	Unit	Min	Max	Factory Set	Description
LCD Contrast	-	30	50	31	This parameter is used to set LCD contrast. Adjust for the best viewing angle.
Screen Scroll Timer	sec	0	250	0	The screen will scroll between different measurements with this interval. If set to zero, the screen scroll will be disabled.
Language	-	0	1	0	<b>0:</b> English language selected. <b>1:</b> Local language selected. This language may depend on the country where the unit is intended to be used.
Genset Default Display	-	0	4	0	This parameter selects the screen which is displayed during genset on load operation. <b>0:</b> genset voltages table <b>1:</b> genset currents and freq. table <b>2:</b> genset kW and pf table <b>3:</b> genset kVA and kVA <sub>r</sub> table <b>4:</b> genset average measurements
Status Prompt Window Enable	-	0	1	0	<b>0:</b> Status prompts disabled <b>1:</b> Status prompts enabled
Fault Holdoff Timer	sec	0	120	12	This parameter defines the delay after the engine runs and before the fault monitoring is enabled.
Alarm Relay Timer	sec	0	120	60	This is the period during which the <b>ALARM</b> relay is active. If the period is set to 0, this will mean that the period is unlimited.
Intermittent Alarm Relay	-	0	1	0	<b>0:</b> continuous <b>1:</b> intermittent (turns on and off every second)
Emergency Backup Operation	-	0	1	0	<b>0:</b> In RUN mode, the load will not be transferred to the genset even if the mains fails. <b>1:</b> In RUN mode, the load will be transferred to the genset if the mains fails.
Exerciser Enable	-	0	1	0	<b>0:</b> automatic exerciser disabled <b>1:</b> automatic exerciser enabled
Exercise Period	-	0	1	0	<b>0:</b> exercise once per week <b>1:</b> exercise once per month The exact exerciser day and time is adjusted within the EXERCISE SCHEDULE section.
Exercise Off/On Load	-	0	1	1	<b>0:</b> Exercise at <b>RUN</b> mode <b>1:</b> Exercise at <b>TEST</b> mode

## 16.1. CONTROLLER CONFIGURATION GROUP (continued)

Parameter Definition	Unit	Min	Max	Factory Set	Description
Delayed Simulate Mains	-	0	1	0	<b>0:</b> delayed simulate mains disabled <b>1:</b> delayed simulate mains enabled
Modem / GPS Selection	-	0	5	0	<b>00:</b> no MODEM / no GPS <b>1:</b> Internal MODEM, no GPS <b>2:</b> External Datakom MODEM, no GPS <b>3:</b> External generic MODEM, no GPS <b>4:</b> no MODEM, RS-232 GPS <b>5:</b> Internal MODEM, RS-232 GPS
External Modem / GPS Baud Rate	bps	2400	57600	57600	This is the data rate of the RS-232 port for the external modem / GPS.
SMS Enable	-	0	1	0	<b>0:</b> SMS messages disabled <b>1:</b> SMS messages enabled
GPRS Connection Enable	-	0	1	0	<b>0:</b> GPRS disabled <b>1:</b> GPRS enabled
Rainbow Scada Refresh Rate	sec	0	65535	5	The unit will update the distant monitoring terminal with this rate.
Rainbow Scada Address-1 Port	-	0	65535	0	This is the port number of the first monitoring terminal address.
Rainbow Scada Address-2 Port	-	0	65535	0	This is the port number of the second monitoring terminal address.
SMTP Port	-	0	65535	587	This is the port number used for e-mail sending.

## 16.1. CONTROLLER CONFIGURATION GROUP (continued)

Parameter Definition	Unit	Min	Max	Factory Set	Description
Modbus Address	-	0	240	1	This is the modbus controller identity used in Modbus communication.
RS-485 Baud Rate	bps	2400	57600	9600	This is the data rate of the RS-485 Modbus port.
Oil Pressure Switch Priority	-	0	1	0	<b>0:</b> crank cut is performed through oil pressure switch and oil pressure sender reading <b>1:</b> crank cut is performed only through oil pressure switch
Flashing Relay ON Timer	min	0	1200	0	<b>Delayed Simulate Mains Operation:</b> max genset running time after Simulate Mains signal disappears. <b>Dual Genset Systems:</b> flashing relay ON state duration timer.
Flashing Relay OFF Timer	min	0	1200	0	<b>Dual Genset Systems:</b> flashing relay OFF state duration.
Real Time Clock Adjust	-	0	255	117	This parameter trims precisely the real time clock circuit. Values from 0 to 63 speed up the clock with 0.25sec/day steps. Values from 127 to 64 slow down the clock with 0.25sec/day steps.
Hysteresis Voltage	V-AC	0	30	8	This parameter provides the mains and genset voltage limits with a hysteresis feature in order to prevent faulty decisions. For example, when the mains are present, the mains voltage low limit will be used as the programmed low limit. When the mains fail, the low limit will be incremented by this value. It is advised to set this value to 8 volts.
Engine Control Only	-	0	1	0	<b>0:</b> Genset control <b>1:</b> Engine control (no alternator)
Alternator Pole Pairs	-	1	8	2	This parameter is used for frequency to rpm conversion. For a 1500/1800 rpm engine select 2. For a 3000/3600 rpm engine select 1.
RPM from genset frequency	-	0	1	1	<b>0:</b> read rpm from the MPU input <b>1:</b> convert frequency to rpm (using Alternator Pole Pairs)
Crank Teeth Count	-	1	244	30	This is the number of pulses generated by the magnetic pickup sensing unit in one turn of the flywheel.

## 16.1. CONTROLLER CONFIGURATION GROUP (continued)

Parameter Definition	Unit	Min	Max	Factory Set	Description
SMS on Mains Change	-	0	1	0	This parameter controls SMS sending when mains voltages status is changed. No warnings generated. <b>0:</b> no SMS on mains failed or restored <b>1:</b> SMS sent on mains failed or restored
SMS on IP Change	-	0	1	0	This parameter controls SMS sending when IP address of GPRS connection is changed. No warnings generated. <b>0:</b> no SMS on IP change <b>1:</b> SMS sent on IP change
E-mail on IP Change	-	0	1	0	This parameter controls e-mail sending when IP address of GPRS or ethernet connection is changed. No warnings generated. <b>0:</b> no e-mail on IP change <b>1:</b> e-mail sent on IP change
Fuel Pump Low Limit	%	0	100	20	If the fuel level measured from the sender input falls below this level, then the FUEL PUMP function will become active.
Fuel Pump High Limit	%	0	100	80	If the fuel level measured from the sender input goes above this level, then the FUEL PUMP function will become passive.
Warning Before Start	-	0	1	1	This parameter controls the activation of the ALARM output during "Engine Start Delay" timer before engine run. <b>0:</b> no warning before start <b>1:</b> warning before start
Latch all Warnings	-	0	1	0	<b>0:</b> warnings are latching/non-latching on parameter control <b>1:</b> all warnings are latched. Even if the fault source is removed, warnings will persist until manually reset.
Remote Control Enable	-	0	1	1	This parameter controls remote control of the unit through Rainbow, Modbus and Modbus TCP/IP. <b>0:</b> remote control disabled <b>1:</b> remote control enabled
Annunciator Mode	-	0	1	0	<b>0:</b> normal operation <b>1:</b> the unit becomes an annunciator of the remote unit. Engine/genset control functions are disabled.
CT Location	-	Gen	Load	Gen	<b>0:</b> CTs are at the genset side. Mains currents are not measured. <b>1:</b> CTs are at load side. Both mains and genset currents are monitored following contactor status.
Reverse CT Direction	-	0	1	0	This parameter is useful to invert all CT polarities at the same time. <b>0:</b> normal CT polarity assumed. <b>1:</b> reverse CT polarity assumed.

## 16.1. CONTROLLER CONFIGURATION GROUP (continued)

Parameter Definition	Unit	Min	Max	Factory Set	Description
Unit Functionality	-	0	3	AMF	<p><b>0:</b> AMF functionality. The unit controls both engine and load transfer. The genset starts based on mains status.</p> <p><b>1:</b> ATS functionality. The unit controls the load transfer and issues genset start signal based on mains status.</p> <p><b>2:</b> REMOTE START functionality. The unit controls engine and alternator. The genset starts with external signal.</p> <p><b>3:</b> RESERVED. Not used.</p>
LCD Backlight Dimming Delay	min	0	1440	60	If no button is pressed during this period, then the unit will reduce the LCD screen backlight intensity in for economy.
Fuel Filling Timer	sec	0	36000	0	<p>After activation of the fuel pump function, if the <b>Fuel Pump High Limit</b> level is not reached, then the fuel pump will stop for safety.</p> <p>If this parameter is set to zero, then the timer is unlimited.</p>
SMS Commands Enabled	-	0	1	0	<p><b>0:</b> SMS commands not accepted</p> <p><b>1:</b> SMS commands are accepted but from listed telephone numbers only.</p>
Open with Last Mode	-	0	1	0	<p><b>0:</b> The unit powers up in STOP mode</p> <p><b>1:</b> The unit powers up in the same operating mode before power down.</p>
Pre-Transfer Delay	sec	0	60	0	<p>If this parameter is not zero, the unit will activate the <b>Wait Before Transfer</b> output function during this timer, before initiating a load transfer.</p> <p>This function is designed for elevator systems, in order to bring the cabin to a floor and open doors before transfer.</p>
E-mail on mains change	-	0	1	0	<p><b>0:</b> No e-mail at mains status changes</p> <p><b>1:</b> E-mails sent at mains status change</p>
Enable Auto not Ready Warning	-	0	1	0	<p><b>0:</b> Auto not Ready Warning disabled</p> <p><b>1:</b> Auto not Ready Warning enabled</p>
Fuel Pulses from MPU input	-	0	1	0	<p><b>0:</b> MPU input is used for engine speed detection</p> <p><b>1:</b> MPU input is used for reading the flowmeter pulses during fuel filling.</p>
Fuel Pulses per Volume	-	0	65000	1000	<b>This is the number of pulses produced by the flowmeter for the unit volume. This parameter is characteristic of the flowmeter used and should be set according to the flowmeter data.</b>
Fuel Counter Unit	Lt/gal	-	-	liters	<b>This is the unit for the fuel counter</b>

## 16.1. CONTROLLER CONFIGURATION GROUP (continued)

Parameter Definition	Unit	Min	Max	Factory Set	Description
SMS on Engine Run/Stop	-	0	1	0	This parameter controls SMS sending when the engine runs or stops. No warnings generated. <b>0:</b> no SMS on engine run/stop <b>1:</b> SMS sent on engine run/stop
E-mail on Engine Run/Stop	-	0	1	0	This parameter controls e-mail sending when the engine runs or stops. No warnings generated. <b>0:</b> no e-mail on engine run/stop <b>1:</b> e-mail sent on engine run/stop
Fuel Counter Type	-	0	1	0	This parameter determines the purpose of fuel pulses <b>0:</b> Fuel filling pulses, increment fuel counter <b>1:</b> Fuel consumption pulses, display consumption.
Dual Genset Equal Aging Enabled	-	0	1	0	<b>0:</b> Equal aging not enabled <b>1:</b> Equal aging enabled
CT Secondary Rating	-	0	1	0	<b>0:</b> xxx/5A <b>1:</b> xxx/1A
Automatic Topology Detection	-	0	1	0	If this parameter is enabled, when the engine runs, the controller will detect the connection topology automatically and will select alarm levels accordingly. <b>0:</b> auto detect not enabled <b>1:</b> auto detect enabled
Maintenance Done Warning Enable	-	0	1	0	If enabled, the unit will generate a non-visual warning when maintenance counters are reset. In consequence, SMS and e-mails will be sent, the warning will be visible on the central monitoring system. <b>0:</b> maintenance warning disabled <b>1:</b> maintenance warning enabled
Stop Status Screens	-	0	1	0	<b>0:</b> Enable status screens <b>1:</b> Disable status screens
Time Zone	min	-720	+720	0	This parameter adjusts the time zone of the controller, in order to allow internal real time clock to be synchronized to the UTC time.
GSM Location Information	-	0	1	0	<b>0:</b> no location information from GSM <b>1:</b> location information read from GSM system.
Disable STOP at Loaddump	-	0	1	0	<b>0:</b> When Loaddump alarm occurs, genset contactor opens and genset runs until the end of the cooldown period. <b>1:</b> When Loaddump alarm occurs, genset contactor opens but the genset continues running without timeout.

## 16.2. ELECTRICAL PARAMETERS GROUP

Parameter Definition	Unit	Min	Max	Factory Set	Description
Current Transformer Primary	Amp	1	5000	500	This is the rated value of current transformers. All transformers must have the same rating. The secondary of the transformer will be 5 Amps.
Voltage Transformer Ratio	-	0	5000	1.0	This is the voltage transformer ratio. This value will multiply all voltage and power readings. If transformers are not used, the ratio should be set to 1.0
Nominal Voltage	V-AC	0	300	230	The nominal value of genset and mains voltages. Voltage limits are defined by reference to this value.
Nominal Frequency	Hz	0	500	50	The nominal value of genset and mains frequency. Frequency limits are defined by reference to this value.
Nominal Voltage-2	V-AC	0	300	120	When secondary voltage is selected, this is the nominal value of genset and mains voltages. Voltage limits are defined by reference to this value.
Nominal Frequency-2	Hz	0	500	60	When secondary frequency is selected, this is nominal value of genset and mains frequency. Frequency limits are defined by reference to this value.
Nominal Voltage-3	V-AC	0	300	120	When tertiary voltage is selected, this is the nominal value of genset and mains voltages. Voltage limits are defined by reference to this value.
Nominal Frequency-3	Hz	0	500	60	When tertiary frequency is selected, this is nominal value of genset and mains frequency. Frequency limits are defined by reference to this value.
Mains Voltage Low Limit	%	V-100	V+100	V-20%	If one of the mains phases goes under this limit, it means that the mains are off and starts the transfer to the genset in <b>AUTO</b> mode. The value is defined with reference to Nominal Voltage.
Mains Voltage High Limit	%	V-100	V+100	V+20%	If one of the mains phases goes over this limit, it means that the mains are off and starts the transfer to the genset in <b>AUTO</b> mode. The value is defined with reference to Nominal Voltage.
Mains Voltage Fail Timer	sec	0	10	1	If at least one of the mains phase voltages goes outside of the limits during this timer, it means that the mains are off and it starts the transfer to the genset in <b>AUTO</b> mode.



## 16.2. ELECTRICAL PARAMETERS GROUP (continued)

Parameter Definition	Unit	Min	Max	Factory Set	Description
Instant Mains Dropout	%	0	50	0	If the mains phase voltages are outside limits, but not more than this parameter (with reference to nominal voltage), then the genset will run without releasing the mains contactor. When the genset is ready to take the load, the load will be transferred. If this parameter is set to zero then the mains contactor is immediately released at mains failure.
Mains Frequency Low Limit	%	F-100	F+100	F-10%	If the mains frequency goes under this limit, it means that the mains are off and starts the transfer to the genset in <b>AUTO</b> mode. The value is defined with reference to Nominal Frequency.
Mains Frequency High Limit	%	F-100	F+100	F+10%	If the mains frequency goes over this limit, it means that the mains are off and starts the transfer to the genset in <b>AUTO</b> mode. The value is defined with reference to Nominal Frequency.
Mains Frequency Fail Timer	sec	0	10	1	If the mains frequency goes outside of the limits during this timer, it means that the mains are off and starts the transfer to the genset in <b>AUTO</b> mode.
Genset Low Voltage Warning Limit	%	V-100	V+100	V-15%	If one of the genset phase voltages goes under this limit when feeding the load, this will generate a <b>GENSET LOW VOLTAGE</b> warning.
Genset Low Voltage Shutdown Limit	%	V-100	V+100	V-20%	If one of the genset phase voltages goes under this limit when feeding the load, this will generate a <b>GENSET LOW VOLTAGE</b> shutdown alarm and the engine will stop.
Genset High Voltage Warning Limit	%	V-100	V+100	V+15%	If one of the genset phase voltages goes over this limit when feeding the load, this will generate a <b>GENSET HIGH VOLTAGE</b> warning.
Genset High Voltage Shutdown Limit	%	V-100	V+100	V+20%	If one of the genset phase voltages goes over this limit when feeding the load, this will generate a <b>GENSET HIGH VOLTAGE</b> shutdown alarm and the engine will stop.
Genset Voltage Fail Timer	sec	0	10	1	If at least one of the genset phase voltages goes outside of the limits during this timer, a genset voltage fault will occur.

## 16.2. ELECTRICAL PARAMETERS GROUP (continued)

Parameter Definition	Unit	Min	Max	Factory Set	Description
Genset Low Frequency Warning Limit	%	F-100	F+100	V-15%	If the genset frequency goes under this limit when feeding the load, this will generate a <b>GENSET LOW FREQUENCY</b> warning.
Genset Low Frequency Shutdown Limit	%	F-100	F+100	F-20%	If the genset frequency goes under this limit when feeding the load, this will generate a <b>GENSET LOW FREQUENCY</b> shutdown alarm and the engine will stop.
Genset High Frequency Warning Limit	%	F-100	F+100	F+15%	If the genset frequency goes over this limit when feeding the load, this will generate a <b>GENSET HIGH FREQUENCY</b> warning.
Genset High Frequency Shutdown Limit	%	F-100	F+100	F+20%	If the genset frequency goes over this limit when feeding the load, this will generate a <b>GENSET HIGH FREQUENCY</b> shutdown alarm and the engine will stop.
Genset Frequency Fail Timer	sec	0	10	1	If the genset frequency goes outside of the limits during this timer, a genset frequency fault will occur.
Low Battery Voltage Warning Limit	V-DC	5.0	35.0	12.0	If the battery voltage falls below this limit, this will generate a <b>LOW BATTERY</b> warning.
Low Battery Voltage Shutdown Limit	V-DC	5.0	35.0	9.0	If the battery voltage falls below this limit, this will generate a <b>LOW BATTERY</b> shutdown alarm and the engine will stop.
High Battery Voltage Warning Limit	V-DC	5.0	35.0	29.0	If the battery voltage goes over this limit, this will generate a <b>HIGH BATTERY</b> warning.
High Battery Voltage Shutdown Limit	V-DC	5.0	35.0	30.0	If the battery voltage goes over this limit, this will generate a <b>HIGH BATTERY</b> shutdown alarm and the engine will stop.
Battery Voltage Fail Timer	sec	0	10	3	If the battery voltage goes outside of the limits during this timer, a battery voltage fault will occur.
Genset Voltage Unbalance Limit	%	0	100	0.0	If any genset phase voltage differs from the average more than this limit, it will generate a Voltage Unbalance fault condition. The action taken upon fault condition is programmable. If this parameter is set to 0.0 then voltage unbalance is not monitored
Genset Voltage Unbalance Action	-	0	3	0	<b>0:</b> no action <b>1:</b> shutdown alarm <b>2:</b> loaddump alarm <b>3:</b> warning

## 16.2. ELECTRICAL PARAMETERS GROUP (continued)

Parameter Definition	Unit	Min	Max	Factory Set	Description
Genset Current Unbalance Limit	%	0	100	0.0	If any genset phase current differs from the average more than this limit, it will generate a Current Unbalance fault condition. The action taken upon fault condition is programmable. If this parameter is set to 0.0 then voltage unbalance is not monitored
Genset Current Unbalance Action	-	0	3	0	<b>0:</b> no action <b>1:</b> shutdown alarm <b>2:</b> loaddump alarm <b>3:</b> warning
Genset Reverse Power Warning Limit	kW	0	50000	0	If the genset power is negative and goes above this limit then a <b>REVERSE POWER</b> warning will be generated. If this parameter is set to 0 then reverse power fault is not monitored.
Genset Reverse Power Loaddump Limit	kW	0	50000	0	If the genset power is negative and goes above this limit then a <b>REVERSE POWER</b> loaddump will be generated.
Genset Reverse Power Fail Timer	sec	0	120	5	If the genset power is negative and over limits during this timer, a reverse power fault will occur.
Genset Overcurrent Limit	Amp	0	50000	0	If one of the genset phase currents goes over this limit when feeding the load, this will generate a genset overcurrent fault condition. The action taken upon fault condition is programmable. If this parameter is set to 0 then overcurrent fault is not monitored.
Genset Overcurrent Limit-2	Amp	0	50000	0	When secondary voltage is selected, if one of the genset phase currents goes over this limit when feeding the load, this will generate a genset overcurrent fault condition. The action taken upon fault condition is programmable. If this parameter is set to 0 then overcurrent fault is not monitored.
Genset Overcurrent Limit-3	Amp	0	50000	0	When tertiary voltage is selected, if one of the genset phase currents goes over this limit when feeding the load, this will generate a genset overcurrent fault condition. The action taken upon fault condition is programmable. If this parameter is set to 0 then overcurrent fault is not monitored.
Genset Overcurrent Action	-	0	3	0	<b>0:</b> shutdown alarm <b>1:</b> loaddump alarm
Overcurrent Time Multiplier	0	1	64	16	This parameter defines the reaction speed of the overcurrent detector. A higher number means higher sensitivity. Detailed explanation is given at chapter: "Overcurrent Protection"

## 16.2. ELECTRICAL PARAMETERS GROUP (continued)

Parameter Definition	Unit	Min	Max	Factory Set	Description
Genset Overload Limit	kW	0	50000	0	If the total genset active power goes over this limit when feeding the load, this will generate a genset overload loaddump alarm. If this parameter is set to 0 then overload fault is not monitored.
Genset Overload Fail Timer	sec	0	120	3	If the genset active power is over the limit during this timer, an overload fault will occur.
Load Shedding Low Limit	kW	0	50000	0	If the genset power goes below this limit then the load shedding relay will be deactivated. Review chapter "Load Shedding" for more details.
Load Shedding High Limit	kW	0	50000	0	If the genset power goes above this limit then the load shedding relay will be activated. Review chapter "Load Shedding" for more details.
Load Add Delay	sec	0	240	0	This is the minimum delay between 2 load_add pulses. Review chapter "Load Shedding" for more details.
Load Subtract-Add Delay	min	0	120	0	This is the minimum delay required for a load_add pulse after a load_substract pulse. Review chapter "Load Shedding" for more details.
Mains Waiting Timer	sec	0	50000	30	This is the time between the mains voltages and frequency entered within the limits and the generator contactor is deactivated.
Mains Connection Topology	-	0	7	5	This is the connection topology of mains voltages and CTs. Detailed explanations are given in the chapter: "TOPOLOGIES". <b>0:</b> 2 phase, 3 wire L1-L2 <b>1:</b> 2 phase, 3 wire L1-L3 <b>2:</b> 3 phase, 3 wire <b>3:</b> 3 phase, 3 wire, 2CTs L1-L2 <b>4:</b> 3 phase, 3 wire, 2CTs L1-L3 <b>5:</b> 3 phase, 4 wire star <b>6:</b> 3 phase, 4 wire delta <b>7:</b> single phase, 2 wire
Genset Connection Topology	-	0	7	5	This is the connection topology of genset voltages and CTs. Detailed explanations are given in the chapter: TOPOLOGIES. <b>0:</b> 2 phase, 3 wire L1-L2 <b>1:</b> 2 phase, 3 wire L1-L3 <b>2:</b> 3 phase, 3 wire <b>3:</b> 3 phase, 3 wire, 2CTs L1-L2 <b>4:</b> 3 phase, 3 wire, 2CTs L1-L3 <b>5:</b> 3 phase, 4 wire star <b>6:</b> 3 phase, 4 wire delta <b>7:</b> single phase, 2 wire

## 16.2. ELECTRICAL PARAMETERS GROUP (continued)

Parameter Definition	Unit	Min	Max	Factory Set	Description
Mains Contactor Timer	sec	0	600	0.5	This is the period after the generator contactor has been deactivated and before the mains contactor has been activated.
Mains MCB Close Pulse	sec	0	10	0.5	After the mains MCB_undervoltage coil is energized and mains MCB_undervoltage coil timer is elapsed, the mains MCB_close relay will be activated during this period. Review chapter " <b>Motorized Circuit Breaker Control</b> " for more details.
Mains MCB Open Pulse	sec	0	10	0.5	The mains MCB_open relay will be activated during this period. Review chapter " <b>Motorized Circuit Breaker Control</b> " for more details.
Mains MCB Under Voltage Coil Timer	sec	0	10	0.5	The mains MCB_undervoltage coil is energized during this period before the mains MCB_close relay is activated. Review chapter " <b>Motorized Circuit Breaker Control</b> " for more details.
MCB Alarm Level	-	0	1	0	<b>0</b> : shutdown alarm <b>1</b> : loaddump alarm
Mains MCB Fail Timer	sec	0	600	2.0	If a mains MCB feedback input is defined and if the mains MCB fails to change position before the expiration of this timer, then a fault condition occurs.
Mains Phase Order Check Enable	-	0	1	0	<b>0</b> : mains phase order checking disabled <b>1</b> : if mains phase order is faulty, then a warning is given and mains contactor deenergized.
Genset Contactor Timer	sec	0	600	0.5	This is the period after the mains contactor has been deactivated and before the genset contactor has been activated.
Genset MCB Close Pulse	sec	0	10	0.5	After the genset MCB_undervoltage coil is energized and genset MCB_undervoltage coil timer is elapsed, the genset MCB_close relay will be activated during this period. Review chapter " <b>Motorized Circuit Breaker Control</b> " for more details.
Genset MCB Open Pulse	sec	0	10	0.5	The genset MCB_open relay will be activated during this period. Review chapter " <b>Motorized Circuit Breaker Control</b> " for more details.
Genset MCB Under Voltage Coil Timer	sec	0	10	0.5	The genset MCB_undervoltage coil is energized during this period before the genset MCB_close relay is activated. Review chapter " <b>Motorized Circuit Breaker Control</b> " for more details.

## 16.2. ELECTRICAL PARAMETERS GROUP (continued)

Parameter Definition	Unit	Min	Max	Factory Set	Description
GCB Alarm Level	-	0	1	0	<b>0:</b> shutdown alarm <b>1:</b> loaddump alarm
Genset MCB Fail Timer	sec	0	600	2.0	If a genset MCB feedback input is defined and if the genset MCB fails to change position before the expiration of this timer, then a fault condition occurs.
Genset Phase Order Check Enable	-	0	1	0	<b>0:</b> genset phase order checking disabled <b>1:</b> if genset phase order is faulty, then a genset phase order fail loaddump alarm is given.
Busbar Fail Timer	sec	0	30	2.0	When a genset closes to the Busbar, if the mater genset controller does detect the Busbar voltage at the expiration of this period, a "BUSBAR FAIL" fault condition will occur.
Busbar Ready Timer	sec	0	30	2.0	This is the delay after all generators close to the busbar and before the master genset controller acknowledges "Busbar ready" signal.
Multi Load Subtract Power Level	kW	0	65000	0	When the genset active power goes over this limit, the controller will start subtracting load as described in chapter <b>Five Step Load Management</b> .
Multi Load Add Power Level	kW	0	65000	0	When the genset active power goes below this limit, the controller will start adding load as described in chapter <b>Five Step Load Management</b> .
Multi Load Subtract Start Delay	sec	0	36000	0	If the load stays over the <b>Multi Load Subtract Power Level</b> parameter during this timer, then 1 step of load is subtracted.
Multi Load Subtract Wait Delay	sec	0	36000	0	This is the minimum period between two load subtract operations.
Multi Load Add Start Delay	sec	0	36000	0	If the load stays below the <b>Multi Load Add Power Level</b> parameter during this timer, then 1 step of load is added.
Multi Load Add Wait Delay	sec	0	36000	0	This is the minimum period between two load add operations.
Excess power Warning Limit	kW	0	50000	0	If the genset active power goes above this limit then the controller will give an Excess Power Warning.

### 16.3. ENGINE PARAMETERS GROUP

Parameter Definition	Unit	Min	Max	Factory Set	Description
Nominal RPM	rpm	0	50000	1500	The nominal value of engine rpm. Low-high rpm limits are defined by reference to this value.
Nominal RPM-2	rpm	0	50000	1800	When secondary frequency is selected, this is the nominal value of engine rpm. Low-high rpm limits are defined by reference to this value.
Nominal RPM-3	rpm	0	50000	1800	When tertiary frequency is selected, this is the nominal value of engine rpm. Low-high rpm limits are defined by reference to this value.
Low RPM Warning Limit	%	R-100	R+100	R-10%	If the engine rpm goes under this limit when feeding the load, this will generate a <b>GENSET LOW RPM</b> warning.
Low RPM Shutdown Limit	%	R-100	R+100	R-15%	If the engine rpm goes under this limit when feeding the load, this will generate a <b>GENSET LOW RPM</b> shutdown alarm and the engine will stop.
High RPM Warning Limit	%	R-100	R+100	R+10%	If the engine rpm goes over this limit when feeding the load, this will generate a <b>GENSET HIGH RPM</b> warning.
High RPM Shutdown Limit	%	R-100	R+100	R+15%	If the engine rpm goes over this limit when feeding the load, this will generate a <b>GENSET HIGH RPM</b> shutdown alarm and the engine will stop.
RPM Fail Timer	sec	0	10	3	If the engine rpm goes outside of the limits during this timer, an engine speed fault will occur.
Overspeed Overshoot Limit	%	HRSL-100	HRSL+100	HRSL+10%	If the engine rpm goes over the "High RPM Shutdown Limit" by this quantity, this will generate immediately a <b>GENSET HIGH RPM</b> shutdown alarm and the engine will stop.
Loss of Signal Check	-	0	1	0	0: speed signal existence not checked 1: If the speed signal is lost, it will generate a Speed Signal Lost fault condition. The action taken upon fault condition is programmable.
Loss of Speed Signal Action	-	0	2	0	<b>0:</b> shutdown alarm <b>1:</b> loaddump alarm <b>2:</b> warning
Loss of Speed Signal Timer	sec	0	240	0	If the speed signal is lost during this timer, a Speed Signal Lost fault will occur.
Low Charge Voltage Warning Limit	V-DC	0	40	6.0	If the charge alternator voltage goes under this limit, a charge alternator voltage warning will occur.
Low Charge Voltage Shutdown Limit	V-DC	0	40	4.0	If the charge alternator voltage goes under this limit, a charge alternator voltage shutdown will occur and the engine will stop.



### 16.3. ENGINE PARAMETERS GROUP (continued)

Parameter Definition	Unit	Min	Max	Factory Set	Description
Charge Voltage Fail Timer	sec	0	120	1	If the charge alternator voltage goes under limits during this timer, a charge alternator voltage fault will occur.
Engine Heating Temperature	°C	0	80	0	If it is requested that the engine runs without load until reaching a certain temperature, this parameter defines the temperature.
Engine Start Delay	min	0	720	1	This is the time between the mains fails and the fuel solenoid turns on before starting the genset. It prevents unwanted genset operation in battery backed-up loads.
Preheat Timer	sec	0	30	0	This is the time after the fuel solenoid is energized and before the genset is started. During this period the <b>PREHEAT</b> relay output is energized (if assigned by <b>Relay Definitions</b> )
Crank Timer	sec	1	15	6	This is the maximum start period. Starting will be automatically cancelled if the genset fires before the timer.
Wait Between Starts	sec	1	240	10	This is the waiting period between two start attempts.
Engine Heating Timer	sec	0	240	4	This is the period used for engine heating before load transfer.
Engine Heating Method	-	0	1	0	The genset will not take the load before engine heating is completed. <b>0:</b> engine is heated during <b>Engine Heating Timer</b> . <b>1:</b> engine is heated until the coolant temperature reaches the <b>Engine Heating Temperature</b> and at least during the <b>Engine Heating Timer</b> .
Cooldown Timer	sec	0	600	120	This is the period that the generator runs for cooling purpose after the load is transferred to mains.
Stop Solenoid Timer	sec	0	90	10	This is the maximum time duration for the engine to stop. During this period the STOP relay output is energized (if assigned by <b>Relay Definitions</b> ). If the genset has not stopped after this period, a <b>FAIL TO STOP</b> warning occurs.
Number of Starts	-	1	6	3	Number of Starts
Choke Timer	sec	0	240	5	This is the control delay of CHOKE output. The choke output is activated together with the crank output. It is released after this delay or when engine runs (whichever occurs first).



### 16.3. ENGINE PARAMETERS GROUP (continued)

Parameter Definition	Unit	Min	Max	Factory Set	Description
Idle Speed (Run) Timer	sec	0	240	0	When the engine runs, the Idle output relay function will be active during this timer. While the IDLE output is active, low voltage, low frequency and low rpm checks are disabled.
Idle Speed (Stop) Timer	sec	0	240	0	Before the engine stops, the Idle output relay function will be active during this timer. While the IDLE output is active, low voltage, low frequency and low rpm checks are disabled.
Idle Holdoff Timer	sec	0	30	10	While the IDLE period is over, low voltage, low frequency and low speed checks are enabled after the expiration of this timer.
Gas Solenoid Delay	sec	0	240	5	The gas solenoid of the gas engine (if assigned by <b>Relay Definitions</b> ) will be opened after this delay during cranking.
Crank Cut Voltage	V-AC	0	65000	100	The crank relay output is deenergized when the genset phase L1 voltage reaches this limit.
Crank Cut Frequency	Hz	0	100	10	The crank relay output is deenergized when the genset frequency reaches this limit.
Crank Cut RPM	rpm	0	65000	500	The crank relay output is deenergized when the engine rpm reaches this limit.
Crank Cut Charge Voltage	V-DC	0	40	6	The crank relay output is deenergized when the charge alternator voltage reaches this limit.
Crank Cut with Oil Pressure	-	0	1	0	<b>0</b> : no crank cut with oil pressure <b>1</b> : cranking is cut when oil pressure switch is open or the oil pressure measured is above shutdown limit.
Crank Cut with Oil Pressure Delay	sec	0	30	2	If crank cutting with oil pressure is enabled, cranking is cut after this delay when oil pressure switch is open or the oil pressure measured is above shutdown limit.
Charge Input Connected	-	0	1	0	<b>0</b> : Crank cutting with charge input disabled <b>1</b> : Crank cutting with charge input enabled
Fuel Tank Capacity	Lt	0	65000	0	The full capacity of the fuel tank. If this parameter is zero, the fuel quantity in the tank is not displayed.
Fuel Consumption per Hour	%	0	100	0.0	This parameter is the threshold for sending FUEL THEFT and FUELLING sms messages. If this parameter is set to 0, then no Fuel Theft and Fuelling sms messages will be sent. If SMS is required, set this parameter to a value above the hourly fuel consumption of the genset.

### 16.3. ENGINE PARAMETERS GROUP (continued)

Parameter Definition	Unit	Min	Max	Factory Set	Description
Coolant Cooler On	°C	0	250	90	If the coolant temp is above this limit then the cooler relay function will become active.
Coolant Cooler Off	°C	0	250	80	If the coolant temp is below this limit then the cooler relay function will become inactive.
Coolant Heater On	°C	0	250	50	If the coolant temp is below this limit then the heater relay function will become active.
Coolant Heater Off	°C	0	250	60	If the coolant temp is above this limit then the heater relay function will become inactive.
Fan Overrun Timer	sec	0	240	0	The cooler relay will stay active during this timer after the coolant temp is below "Coolant Cooler Off" limit.
Canopy Fan Turn-On	°C	0	250	90	If the canopy temp is above this limit then the canopy fan relay function will become active.
Canopy Fan Turn-Off	°C	0	250	80	If the canopy temp is below this limit then the canopy fan relay function will become inactive.
Ambient Fan Turn-On	°C	0	250	90	If the ambient temp is above this limit then the ambient fan relay function will become active.
Ambient Fan Turn-Off	°C	0	250	80	If the ambient temp is below this limit then the ambient fan relay function will become inactive.
Service-1 Engine Hours	hours	0	5000	250	The <b>SERVICE REQUEST</b> led indicator will turn on after this quantity of engine hours from the last service. If the period is set to '0' no <b>SERVICE REQUEST</b> will be generated depending on service-1 engine hours.
Service-1 Period	month	0	24	6	The <b>SERVICE REQUEST</b> led indicator will turn on after this amount of time from the last service. If the period is set to '0' no <b>SERVICE REQUEST</b> will be indicated depending on Service-1 Period.
Service-1 Alarm Level	-	0	3	3	<b>0:</b> no action <b>1:</b> shutdown alarm <b>2:</b> loaddump alarm <b>3:</b> warning

### 16.3. ENGINE PARAMETERS GROUP (continued)

Parameter Definition	Unit	Min	Max	Factory Set	Description
Service-2 Engine Hours	hours	0	5000	250	The <b>SERVICE REQUEST</b> led indicator will turn on after this quantity of engine hours from the last service. If the period is set to '0' no <b>SERVICE REQUEST</b> will be generated depending on service-2 engine hours.
Service-2 Period	month	0	24	6	The <b>SERVICE REQUEST</b> led indicator will turn on after this amount of time from the last service. If the period is set to '0' no <b>SERVICE REQUEST</b> will be indicated depending on Service-2 Period.
Service-2 Alarm Level	-	0	3	0	0: no action 1: shutdown alarm 2: loaddump alarm 3: warning
Service-3 Engine Hours	hours	0	5000	250	The <b>SERVICE REQUEST</b> led indicator will turn on after this quantity of engine hours from the last service. If the period is set to '0' no <b>SERVICE REQUEST</b> will be generated depending on service-3 engine hours.
Service-3 Period	month	0	24	6	The <b>SERVICE REQUEST</b> led indicator will turn on after this amount of time from the last service. If the period is set to '0' no <b>SERVICE REQUEST</b> will be indicated depending on Service-3 Period.
Service-3 Alarm Level	-	0	3	0	0: no action 1: shutdown alarm 2: loaddump alarm 3: warning
J1939 Enable	-	0	1	0	0: The J1939 port is inoperative. 1: The analog measurements (oil, temp, and rpm) are picked up from the ECU. If the ECU communication is lost, then the engine will be stopped.
J1939 Engine Brand	-	0	15	0	0: GENERIC 1: CUMMINS 2: DETROIT DIESEL 3: DEUTZ 4: JOHN DEERE 5: PERKINS 6: VOLVO 7: CATERPILLAR 8: SCANIA 9: IVECO 10: MTU-MDEC 11: BOSCH Other values: Reserved. Do not use.

### 16.3. ENGINE PARAMETERS GROUP (continued)

Parameter Definition	Unit	Min	Max	Fact.Set	Description
J1939 ECU Type	-	0	7	0	<b>GENERIC ENGINE BRAND</b> 0: Generic <b>CUMMINS ENGINE</b> 0: CM850 1: CM570 <b>DETROIT DIESEL ENGINE</b> 0: Generic <b>DEUTZ ENGINE</b> 0: Generic 1: EMR2 2: EMR3 <b>JOHN DEERE ENGINE</b> 0: Generic <b>PERKINS ENGINE</b> 0: Generic 1: ADEM3 2: ADEM 1.3 <b>VOLVO ENGINE</b> 0: Generic 1: without CIU unit 2: EDC4 <b>CATERPILLAR ENGINE</b> 0: Generic <b>SCANIA ENGINE</b> 0: Generic 1: S6 (Single Speed) 2: S8 (All Speed) <b>IVECO ENGINE</b> 0: Generic 1: Vector 2: NEF/CURSOR <b>MTU-MDEC ENGINE</b> 0: MDEC 302 1: MDEC 201 2: MDEC 303 3: MDEC 304 4: MDEC 506 <b>BOSCH INJECTION SYSTEM</b> 0: Generic 1: EDC 731 2: EDC 9.3

### 16.3. ENGINE PARAMETERS GROUP (continued)

Parameter Definition	Unit	Min	Max	Factory Set	Description
J1939 Speed Adjust	%	-100	+100	0.0	This parameter adjusts the speed of an ECU controlled engine by +/- 8%.
High Air Inlet Temperature Warning Limit	°C	0	200	0	If the air inlet temperature measured through ECU is over this limit, then a high air inlet temperature warning will occur.
High Air Inlet Temperature Alarm Limit	°C	0	200	0	If the air inlet temperature measured through ECU is over this limit, then a high air inlet temperature shutdown/loaddump alarm will occur.
High Air Inlet Temperature Alarm Action	-	0	1		<b>0:</b> shutdown alarm <b>1:</b> loaddump alarm
Low Coolant Level Warning Limit	%	0	100	0	If the coolant level measured through ECU is below this limit, then a low coolant level warning will occur.
Low Coolant Level Alarm Limit	%	0	100	0	If the coolant level measured through ECU is below this limit, then a low coolant level shutdown/loaddump alarm will occur.
Low Coolant Level Alarm Action	-	0	1	0	<b>0:</b> shutdown alarm <b>1:</b> loaddump alarm
Battery Charge Run Voltage	V-DC	0	35.0	0	If the battery voltage goes below this limit the engine will be automatically started in order to charge the battery using the charge alternator.
Battery Charge Run Timer	min	0	1200	0	If the battery voltage goes below the Battery Charge Run Voltage limit, the engine will be automatically run during this period in order to charge the battery using the charge alternator.
Oil Pump Stop Pressure	bars	0	20	0	The oil pump is activated prior to the crank cycle and stopped when this pressure level is reached. If this value is set to zero, then the oil pump is not activated.
Service Reset-1	-	0	1	0	<b>0:</b> no action <b>1:</b> reset service-1 counters
Service Reset-2	-	0	1	0	<b>0:</b> no action <b>1:</b> reset service-3 counters
Service Reset-3	-	0	1	0	<b>0:</b> no action <b>1:</b> reset service-3 counters
Disable ECU speed control	-	0	1	0	<b>0: Engine speed checking is performed with the RPM information coming from the engine ECU unit.</b> <b>1: the RPM information coming from the engine ECU unit is not used for engine speed checking.</b>
J1939 SPN Mask	-	0	65535	0	The SPN number written to this parameter is excuded from engine ECU alarm list.
J1939 FMI Mask	-	0	65535	0	The FMI number written to this parameter is excuded from engine ECU alarm list

## 16.4. ADJUST DATE AND TIME

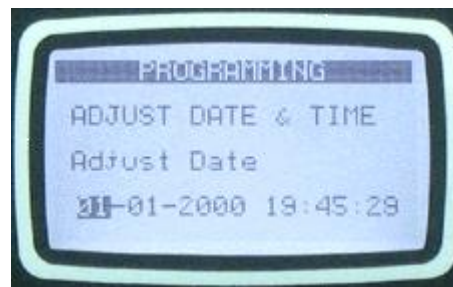
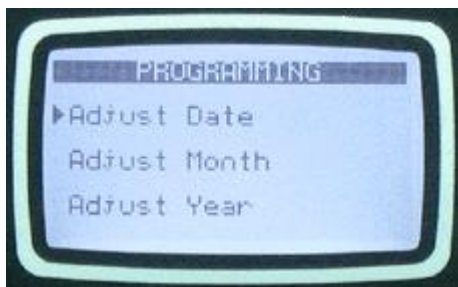

These parameters allow adjusting the battery backup real time clock of the module. Once set, the clock will continue to run even if DC power is removed from the unit.

Parameter Definition	Unit	Min	Max	Description
Date	-	01	31	Current day of the month.
Month	-	01	12	Current month.
Year	-	00	99	Last two digits of the current year.
Hours	-	00	23	Current hour of the day.
Minutes	-	00	59	Current minute of the hour.
Seconds	-	00	59	Current second of the minute.

## 16.5. WEEKLY OPERATION SCHEDULE

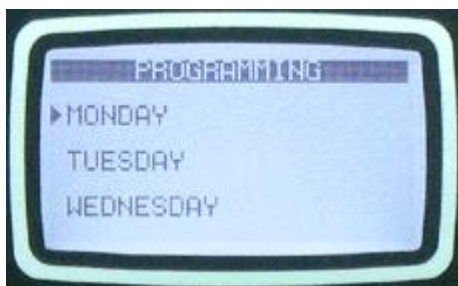

In AUTO mode, it is possible to define the periods where automatic operation is desired. It may be required that the genset does not start at night or weekends.

Weekly schedule programs allow an hourly setting of automatic operation of the unit during one week.

There are 7days x 24hours =144 parameters. Each hour of the week can be independently defined as AUTO or OFF period.



**If automatic operation is disabled by the weekly exerciser, the AUTO led will flash.**

## 16.6. EXERCISER SCHEDULE



The unit provides 7 independent automatic exerciser programs. Automatic exercise may be done in weekly or monthly basis.

If monthly exercise is selected, the week, day and hour is adjustable for each exercise item.

If weekly exercise is selected, the day and hour is adjustable for each exercise item.

Exercise can be done with or without load.

Thus the genset can be instructed to run automatically in given days and times of a week and take the load.

## 16.7. SENDER CONFIGURATION

The unit has 3 analog sender inputs. Only parameters of one sender are explained below. Other senders have identical parameter set.

Each sender has 16 step programmable curves. The sender name and reading unit is freely programmable, thus the sender can be adapted to any type through programming.

Each sender has below programmable parameters:

Parameter Definition	Unit	Min	Max	Factory Set	Description
Sender Type	-	0	15		Selects between predefined sender functions. If this parameter is set to 13-14-15 then the sender name string can be freely entered.
Alarm Level	-	0	1		<b>0:</b> shutdown alarm <b>1:</b> loaddump alarm
Alarm Handling	-	0	3		<b>0:</b> always <b>1:</b> on engine running <b>2:</b> after hold-off timer <b>3:</b> reserved
Sender Open Alarm	-	0	3		If sender resistor is above 5000 ohms, a fault case is generated. This parameter defines the action taken upon fault case. <b>0:</b> no alarm <b>1:</b> shutdown alarm <b>2:</b> loaddump alarm <b>3:</b> warning
Low Alarm Check Enable	0	0	1		The low alarm may be selected as shutdown or loaddump with "alarm level" parameter. <b>0:</b> low value alarm disabled <b>1:</b> low value alarm enabled
Low Warning Check Enable	0	0	1		<b>0:</b> low value warning disabled <b>1:</b> low value warning enabled
High Alarm Check Enable	0	0	1		The high alarm may be selected as shutdown or loaddump with "alarm level" parameter. <b>0:</b> high value alarm disabled <b>1:</b> high value alarm enabled
High Warning Check Enable	0	0	1		<b>0:</b> high value warning disabled <b>1:</b> high value warning enabled
Low Alarm Level	x	0	10000		If enabled, defines the low alarm limit. The low alarm may be selected as shutdown or loaddump with "alarm level" parameter.
Low Warning Level	x	0	10000		If defined, defines the low warning.
High Alarm Level	x	0	10000		If enabled, defines the high alarm limit. The high alarm may be selected as shutdown or loaddump with "alarm level" parameter.
High Warning Level	x	0	10000		If defined, defines the high warning.



Parameter Definition	Unit	Min	Max	Factory Set	Description
Sender Curve-1 ohm	ohms	0	5000		Point-1 ohm value
Sender Curve-1 value	x	0	10000		Point-1 reading
Sender Curve-2 ohm	ohms	0	5000		Point-2 ohm value
Sender Curve-2 value	x	0	10000		Point-2 reading
Sender Curve-3 ohm	ohms	0	5000		Point-3 ohm value
Sender Curve-3 value	x	0	10000		Point-3 reading
Sender Curve-4 ohm	ohms	0	5000		Point-4 ohm value
Sender Curve-4 value	x	0	10000		Point-4 reading
Sender Curve-5 ohm	ohms	0	5000		Point-5 ohm value
Sender Curve-5 value	x	0	10000		Point-5 reading
Sender Curve-6 ohm	ohms	0	5000		Point-6 ohm value
Sender Curve-6 value	x	0	10000		Point-6 reading
Sender Curve-7 ohm	ohms	0	5000		Point-7 ohm value
Sender Curve-7 value	x	0	10000		Point-7 reading
Sender Curve-8 ohm	ohms	0	5000		Point-8 ohm value
Sender Curve-8 value	x	0	10000		Point-8 reading
Sender Curve-9 ohm	ohms	0	5000		Point-9 ohm value
Sender Curve-9 value	x	0	10000		Point-9 reading
Sender Curve-10 ohm	ohms	0	5000		Point-10 ohm value
Sender Curve-10 value	x	0	10000		Point-10 reading
Sender Curve-11 ohm	ohms	0	5000		Point-11 ohm value
Sender Curve-11 value	x	0	10000		Point-11 reading
Sender Curve-12 ohm	ohms	0	5000		Point-12 ohm value
Sender Curve-12 value	x	0	10000		Point-12 reading
Sender Curve-13 ohm	ohms	0	5000		Point-13 ohm value
Sender Curve-13 value	x	0	10000		Point-13 reading
Sender Curve-14 ohm	ohms	0	5000		Point-14 ohm value
Sender Curve-14 value	x	0	10000		Point-14 reading
Sender Curve-15 ohm	ohms	0	5000		Point-15 ohm value
Sender Curve-15 value	x	0	10000		Point-15 reading
Sender Curve-16 ohm	ohms	0	5000		Point-16 ohm value
Sender Curve-16 value	x	0	10000		Point-16 reading
Sender Name	-	-	-		If the sender type parameter is set to zero (not used), this string is used as sender name while displaying the sender reading.
Sender Low Fault String	-	-	-		If the sender type parameter is set to zero (not used), this string is used as sender low value fault in the alarm display.
Sender High Fault String	-	-	-		If the sender type parameter is set to zero (not used), this string is used as sender high value fault in the alarm display.

## 16.8. DIGITAL INPUT CONFIGURATION



The unit has 8 digital inputs. By using external input extension modules, up to 40 inputs in total are available.

Only parameters of one input are explained below. Other inputs have identical parameter set.

The input name is freely programmable, thus the input can be adapted to any functionality through programming.



**The input name entry is made through RainbowPlus program only.**

Each sender has below programmable parameters:

Parameter Definition	Unit	Min	Max	Factory Set	Description
Input Function	-	0	99		Selects between predefined input functions. Selected input name is displayed in the line below. If this parameter is set to 0 then the input name string can be freely entered.
Action	-	0	3		0: shutdown alarm 1: loaddump alarm 2: warning 3: no fault condition from this input.
Sampling	-	0	3		0: always 1: on engine running 2: after hold-off timer 3: reserved
Latching	-	0	1		0: non-latching. The fault disappears when cause is removed. 1: latching. The fault persists even if the cause is removed. Requires manual reset.
Contact type	-	0	1		0: Normally open 1: Normally closed
Switching	-	0	1		0: Battery negative 1: Battery positive
Response delay	-	0	3		0: No delay 1: Delayed (1sec) 2: Delayed (10sec) 3: Delayed (1800sec)

**INPUT FUNCTION LIST**

No	Description	No	Description	No	Description
1	User Defined Function	41	Over Resonance	81	-
2	Low Oil Press. Switch	42	Short-Circuit Alarm	82	-
3	High Temp. Switch	43	Reset Service 1 Alm	83	-
4	Coolant Level Switch	44	Reset Service 2 Alm	84	-
5	Rectifier Fail Switch	45	Reset Service 3 Alm	85	-
6	Emergency Stop	46	Heavy Duty	86	-
7	Alternator High Temp	47	Synchro Genset Run	87	-
8	Excitation Loss Sw.	48	Synch Genset on Load	88	-
9	Low Fuel Switch	49	Program Lock	89	-
10	Earthquake Detector	50	Fire Circuit Press.Sw.	90	-
11	Gen Cont Auxiliary	51	Lamp Test	91	-
12	Mains Cont Auxiliary	52	Combat Mode	92	-
13	Force AUTO Mode	53	Disable Peak Lopping	93	-
14	Force OFF Mode	54	Disable Power Export	94	-
15	Force TEST Mode	55	Tertiary Volt Freq.	95	-
16	Over Load Switch	56	Follower Power Export	96	-
17	Manual Fuel Fill!	57	Remote priority+1	97	-
18	Priority	58	Remote priority+2	98	-
19	Remote Start	59	Remote priority+4	99	-
20	Disable Auto Start	60	Remote priority+8	100	Input not in Use
21	Force to Start	61	Mains restore inhibit		
22	Fault Reset	62	Speed UP		
23	Alarm Mute	63	Speed DOWN		
24	Panel Lock	64	Force parallel op.		
25	Fuel Pump Switch	65	-		
26	Secondary Volt&Freq	66	-		
27	Disable Protections	67	-		
28	Auto Restore Inhibit	68	-		
29	GensetLoadingInhibit	69	-		
30	Air Flap Fault	70	-		
31	Canopy Door Open	71	-		
32	Station Door Open	72	-		
33	Station Over-Heat Sw.	73	-		
34	Weather Cloudy	74	-		
35	Weather Rainy	75	-		
36	Lightning	76	-		
37	Cooler Fan Fault	77	-		
38	Heater Fan Fault	78	-		
39	Canopy Fan Fault	79	-		
40	Station Fan Fault	80	-		

## 16.9. OUTPUT CONFIGURATION

The parameters below define the functions of relay outputs. The unit has 8 relay outputs. All relays have programmable functions, selected from a list.

Relays may be extended up to 40 using **Relay Extension Modules**.. Other relays are in the optional Extension Modules.

Parameter Definition	Factory set	Terminal number	Description
Relay-01	3	4	Factory set as Crank Relay output
Relay-02	1	5	Factory set as Fuel Relay output
Relay-03	2	6	Factory set as Horn Relay output
Relay-04	8	7	Factory set as Preheat Relay output
Relay-05	4	8	Factory set as Stop Relay output
Relay-06	7	9	Factory set as Idle Speed Relay output
Relay-07	6	72	Factory set as Mains Contactor Relay output
Relay-08	5	51	Factory set as Genset Contactor Relay output

Relay-09	1	-	Relay extension module – 1
Relay-10	1	-	Relay extension module – 1
Relay-11	1	-	Relay extension module – 1
Relay-12	1	-	Relay extension module – 1
Relay-13	1	-	Relay extension module – 1
Relay-14	1	-	Relay extension module – 1
Relay-15	1	-	Relay extension module – 1
Relay-16	1	-	Relay extension module – 1
Relay-17	1	-	Relay extension module – 2
Relay-18	1	-	Relay extension module – 2
Relay-19	1	-	Relay extension module – 2
Relay-20	1	-	Relay extension module - 2
Relay-21	1	-	Relay extension module - 2
Relay-22	1	-	Relay extension module - 2
Relay-23	1	-	Relay extension module - 2
Relay-24	1	-	Relay extension module - 2
Relay-25	1	-	Relay extension module - 3
Relay-26	1	-	Relay extension module - 3
Relay-27	1	-	Relay extension module - 3
Relay-28	1	-	Relay extension module - 3
Relay-29	1	-	Relay extension module - 3
Relay-30	1	-	Relay extension module - 3
Relay-31	1	-	Relay extension module - 3
Relay-32	1	-	Relay extension module - 3
Relay-33	1	-	Relay extension module - 4
Relay-34	1	-	Relay extension module - 4
Relay-35	1	-	Relay extension module - 4
Relay-36	1	-	Relay extension module - 4
Relay-37	1	-	Relay extension module - 4
Relay-38	1	-	Relay extension module - 4
Relay-39	1	-	Relay extension module - 4
Relay-40	1	-	Relay extension module - 4



**Below is a short list for reference purposes. Please use the RainbowPlus program for complete selection list.**

## OUTPUT FUNCTION LIST

No	Description	No	Description	No	Description
1	Fuel	46	Pgm Mode Active	91	Remote Control Out 11
2	Horn	47	Engine Running	92	Remote Control Out 12
3	Crank	48	Genset Voltage Ok	93	Remote Control Out 13
4	Stop Solenoid	49	Alarm Check Enable	94	Remote Control Out 14
5	Genset Contactor	50	Oil Pressure Ok!	95	Remote Control Out 15
6	Mains Contactor	51	Shutdown Alarm	96	Remote Control Out 16
7	Idle Speed	52	Loaddump Alarm	97	Multi Load Add Out 1
8	Preheat	53	Warning Alarm	98	Multi Load Subst. Out 1
9	Alternate Crank	54	Shutdown or Loaddump	99	Multi Load Add Out 2
10	Fuel Main Winding	55	Shut. or LDD or Warn	100	Multi Load Subst. Out 2
11	Genset Close Pulse	56	Test Mode	101	Multi Load Add Out 3
12	Genset Open Pulse	57	Auto Mode	102	Multi Load Subst. Out 3
13	Genset UV Coil	58	Manual Mode	103	Multi Load Add Out 4
14	Mains Close Pulse	59	Off Mode	104	Multi Load Subst. Out 4
15	Mains Open Pulse	60	Not In Auto	105	Multi Load Add Out 5
16	Mains UV Coil	61	Genset At Rest	106	Multi Load Subst. Out 5
17	Flashing Relay	62	Waiting Before Fuel	107	Heavy Duty Active
18	Gas Solenoid	63	Preheating	108	ECU Power On
19	Fuel Pump Control	64	Waiting Oil Flash Off	109	Battery Charge Run
20	Choke	65	Engine Heating	110	Fire Circuit PS Active
21	Block Heater	66	Synchronizing	111	Pre-transfer Delay
22	Coolant Cooler	67	Cooling Down	112	Secondary Volt Freq.
23	Coolant Heater	68	Stopping	113	Lamp Test Active
24	Fan Control	69	Protections Disabled	114	Alarm Mute Active
25	Air Flap Control	70	Remote Start Input	115	Combat mode
26	Canopy Fan Control	71	Disable Auto Start	116	Peak Lopping Active
27	Ambient Fan Control	72	Force to Start	117	Power Export Active
28	Remote Start Output	73	Auto Restore Inhibited	118	Master Mains Controller
29	Genset Ready	74	Gen.Loading Inhibited	119	Busbar Ready
30	Bus Bar Contactor	75	Inp.Expansion1Mounted	120	Droop Mode Active
31	Bus Bar Close Pulse	76	Inp.Expansion2Mounted	121	Tertiary Volt Freq
32	Bus Bar Open Pulse	77	Out.Expansion1Mounted	122	Smart Load Management
33	Bus Bar UV Coil	78	Out.Expansion2Mounted	123	Follower mode active
34	Load Shedding	79	Master Unit	124	Oil pump output
35	Load Add	80	Multi Gen. Remote Start	125	Speed Up pulse output
36	Load Substract	81	Remote Control Out 1	126	Speed down pulse output
37	Service 1 Request	82	Remote Control Out 2	127	Volt up pulse output
38	Service 2 Request	83	Remote Control Out 3	128	Volt down pulse output
39	Service 3 Request	84	Remote Control Out 4	129	Synch OK output
40	Mains Ph.Order Fail	85	Remote Control Out 5	130	Zero Power Relay output
41	Genset Ph.Order Fail	86	Remote Control Out 6	131	Fuel Pull-in Coil
42	Auto Ready	87	Remote Control Out 7	132	Crank-1/2
43	Weekly Schedule On	88	Remote Control Out 8	133	Crank-2/2
44	Exerciser On	89	Remote Control Out 9	134	
45	Mains Fail	90	Remote Control Out 10	135	

## 16.10. SITE ID STRING

The site identity string is designed to identify the current controller.

This is the site Id string sent at the beginning of SMS messages, e-mails and web page headers for the identification of the genset sending the message. Any 20 character long string may be entered.

## 16.11. ENGINE SERIAL NUMBER

The engine serial number string is designed to identify the current controller.

This string is added to GSM-SMS messages, e-mails, web page headers etc.

## 16.12. MODEM1-2/SMS1-2-3-4 TELEPHONE NUMBERS

These telephone number buffers accept up to 16 digits, including the wait character (“,”) in order to enable dialing through a pabx.

**If Modem Selection= External PSTN Modem:** First 2 numbers are used for modem calls.

**Other selections:** all numbers are used for SMS sending.



**Enter numbers starting from first character. Do not leave blank characters at the beginning.**

## 16.13. GSM MODEM PARAMETERS

Parameter Definition	Description
APN User Name	The APN (access point name) username may be required by the GSM operator. However some GSM operators may allow access without username. The exact information should be obtained from the GSM operator. Please search the GSM operator's website with "APN" string.
APN Password	If the APN (access point name) username is required by the GSM operator, most probably the APN password will also be required. However some GSM operators may allow access without password. The exact information should be obtained from the GSM operator. Please search the GSM operator's website with "APN" string.
APN Name	The APN (access point name) is always required by the GSM operator. The exact information should be obtained from the GSM operator. Please search the GSM operator's website with "APN" string.
SMS Service Center Number	The SMS service center number may be required by the GSM operator. However some GSM operators may allow SMS sending without SMS service center number. The exact information should be obtained from the GSM operator. Please search the GSM operator's website with "sms service center" string.



**Below GSM modem related parameters are found in the Controller Configuration group.**

Parameter Definition	Unit	Min	Max	Factory Set	Description
GSM Sim Card Pin	-	0000	9999	0	If the GSM SIM card uses pin number, enter the pin number here. If incorrect pin number is entered, then the SIM card will not operate.
SMS Enable	-	0	1	0	<b>0:</b> SMS messages disabled <b>1:</b> SMS messages enabled
GPRS Connection Enable	-	0	1	0	<b>0:</b> GPRS disabled <b>1:</b> GPRS enabled
SMS on Mains Change	-	0	1	0	<b>This parameter controls SMS sending when mains voltages status is changed. No warnings generated.</b> <b>0:</b> no SMS on mains failed or restored <b>1:</b> SMS sent on mains failed or restored
SMS on IP Change	-	0	1	0	<b>This parameter controls SMS sending when IP address of GPRS connection is changed. No warnings generated.</b> <b>0:</b> no SMS on IP change <b>1:</b> SMS sent on IP change

## 16.14. ETHERNET PARAMETERS

Parameter Definition	Factory Set	Description
Rainbow Address-1 Rainbow Address-2	wss1.datakom.com.tr	These parameters accept both internet addresses (like http://datakom.com.tr) and IPv4 addresses (like 78.192.238.116). Information for remote monitoring is sent to these addresses. The port information of these addresses are found in Controller Configuration group.
Mail Account Name	d500_a	This is the account name appearing in the "from" tab of the e-mail recipient. (ex: datakom-d500@gmail.com)
Mail Account Password	d500_1234	This is the e-mail password of above e-mail account.
Mail Server Address	smtp.mail.yahoo.com	This is the Outgoing Mail Server Address of the above e-mail account (ex: smtp.gmail.com)
E-mail Address-1 E-mail Address-2 E-mail Address-3	- - -	These are e-mail recipient addresses where the unit is intended to send e-mail messages. Up to 3 e-mails can be sent at once.



**Below ETHERNET related parameters are found in the Controller Configuration group.**

Parameter Definition	Unit	Min	Max	Factory Set	Description
Rainbow Refresh Rate	sec	0	65535	5	The unit will update the distant monitoring terminal with this rate.
Rainbow Address-1 Port	-	0	65535	0	This is the port number of the first monitoring terminal address.
Rainbow Address-2 Port	-	0	65535	0	This is the port number of the second monitoring terminal address.
SMTP Port	-	0	65535	587	This is the port number used for e-mail sending.
E-mail on IP Change	-	0	1	0	This parameter controls e-mail sending when IP address of GPRS or ethernet connection is changed. No warnings generated. <b>0:</b> no e-mail on IP change <b>1:</b> e-mail sent on IP change



## 17. CRANK CUTTING

In order to insure fast and reliable crank cutting, the unit uses various resources for engine running condition detection.

Cranking is stopped when **at least one** of below conditions is met:

**- Crank timer expired:**

The crank timer is adjusted through **Engine Parameters > Crank Timer**. The maximum allowed timer is 15 seconds.

**- Genset AC voltage over threshold:**

If the genset phase L1 AC voltage reaches **Engine Parameters > Crank Cut Voltage**, then cranking is immediately stopped.

**- Genset frequency over threshold:**

If the genset phase L1 frequency reaches **Engine Parameters > Crank Cut Frequency**, then cranking is immediately stopped.

**- Genset rpm over threshold:**

If the genset rpm reaches **Engine Parameters > Crank Cut RPM**, then cranking is immediately stopped.

**- Charge alternator voltage over threshold**

Following setting is necessary: **Engine Parameters > Charge Input Connected = 1**

If the charge alternator voltage reaches **Engine Parameters > Crank Cut Charge Voltage**, then cranking is immediately stopped.

**- Oil pressure above threshold**

Following setting is necessary: **Engine Parameters > Crank Cut with Oil Pressure = 1**

The crank cutting with oil pressure offers a programmable delay through **Engine Parameters > Crank Cut with Oil Pressure Delay**. The parameter is factory set to 2 seconds.

Both low oil pressure switch and oil pressure sender readings may be used for crank cutting. The oil pressure switch is always used. The sender may be disabled through **Controller Configuration > Oil Pressure Switch Priority** parameter.

If enabled, when oil pressure is detected, cranking is stopped after adjustable timer delay.

## 18. OVERCURRENT PROTECTION (IDMT)

The unit offers a programmable IDMT protection function in order to protect the alternator against excessive currents.

The IDMT (Inverse Definite Minimum Time) protection function has such tripping characteristics that the tripping time varies inversely with the value of current. Beyond a certain current limit the tripping time becomes constant (definite) and causes tripping in minimum time.

The tripping formula is defined as below:

$$t = \frac{TMS}{\left(\frac{I}{I_{set}} - 1\right)^2}$$

**Where:**

**TMS** is the IDMT time multiplier setting. This is also the tripping time at 100% overload.

**I** is the current of the most loaded phase

**I<sub>set</sub>** is the programmed overcurrent limit

**t** is the tripping time in seconds

Currents below the overcurrent limit are allowed to flow for unlimited time. Currents above the limit will cause the IDMT protection to trigger with a delay depending on the strength of the overcurrent. Higher the current, faster the protection will trip.

When a non-tripping overcurrent condition occurs, the unit will keep trace of it. In case of a consecutive overcurrent, the controller will take into account the residual heat caused by the previous overcurrent and will trip faster than usual.

The IDMT multiplier adjusts the sensitivity of the IDMT detector. When the multiplier is low, then tripping will be faster for the same current.

The unit provides separate Overcurrent limits for primary, secondary and tertiary volt/speed/amp settings. Switching from primary volt/freq/amps to secondary or tertiary values will also switch the IDMT detector to the secondary/tertiary setting.

The action of the tripping may be selected as a Load dump (stop after cooldown) or shutdown alarm (immediate stop).

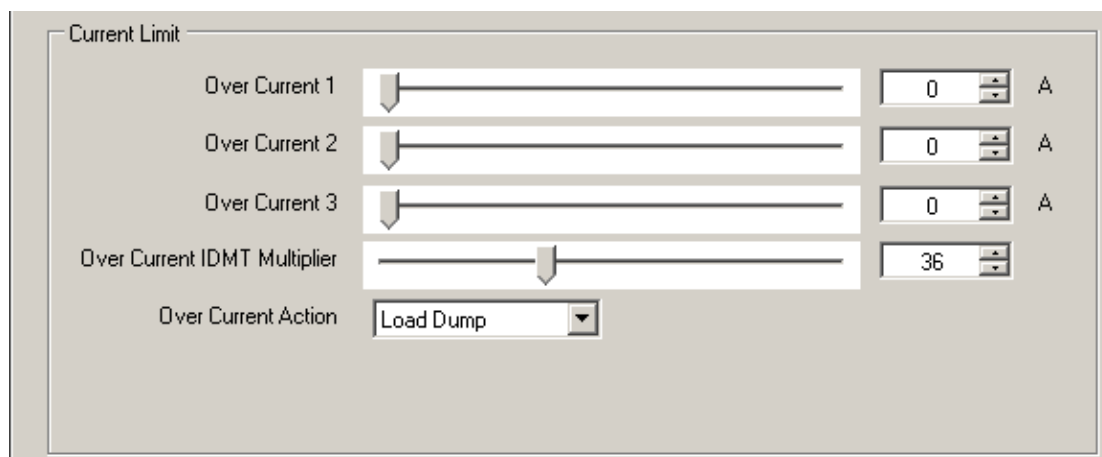

Screenshot from RainbowPlus configuration program, **Generator>Current** section

**Below is a table showing the tripping delay in function of the percent load level (with TMS=36):**

100%	unlimited	170%	73s	240%	18s
110%	3600s	180%	56s	250%	16s
120%	900s	190%	44s	260%	14s
130%	400s	200%	36s	270%	12s
140%	225s	210%	30s	280%	11s
150%	144s	220%	25s	290%	10s
160%	100s	230%	21s	300%	9s

**Below is the tripping delay curve in function of the load level (with TMS=36):**

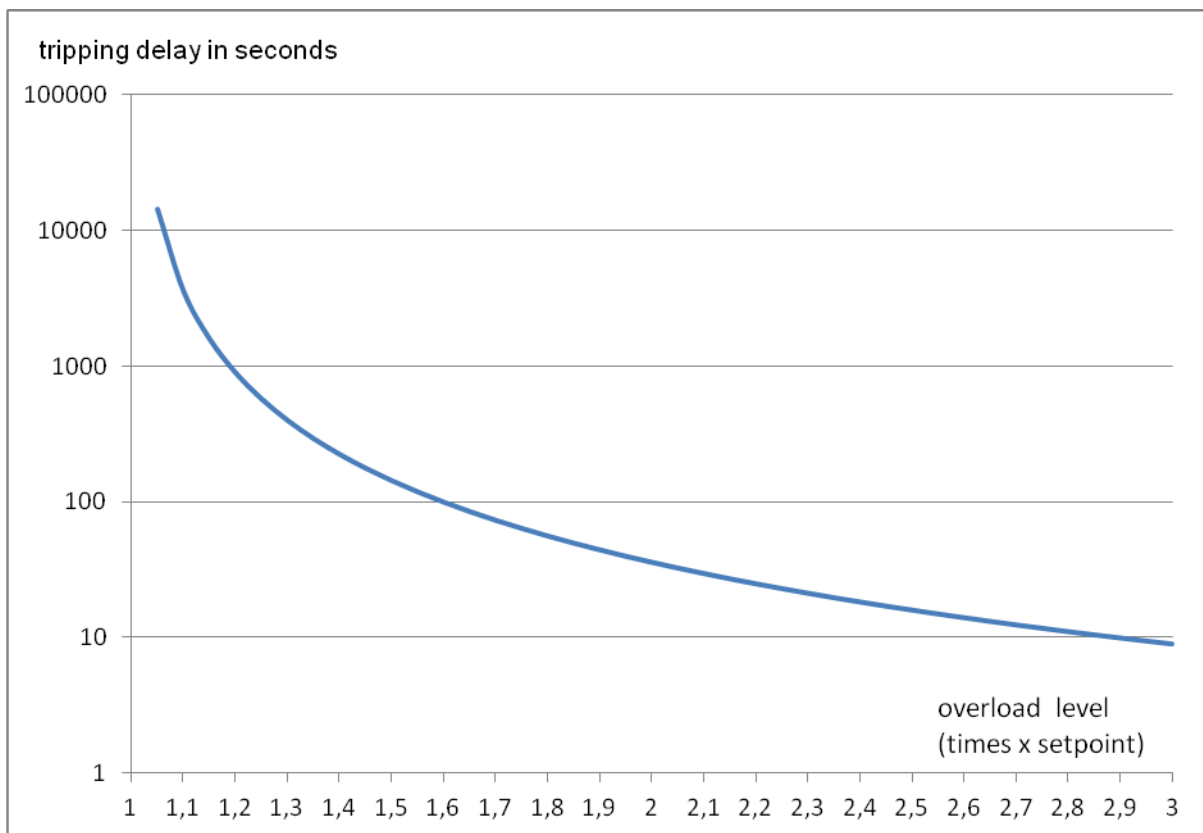

## 19. MOTORIZED CIRCUIT BREAKER CONTROL

The unit offers full control for any brand and model of motorized circuit breakers (MCB).

The MCB control is performed through 3 digital output functions, namely Open, Close and Undervoltage coil controls. Only 2 of these outputs are used in a single application.

Any digital output can be assigned to MCB control signals through programming menu.

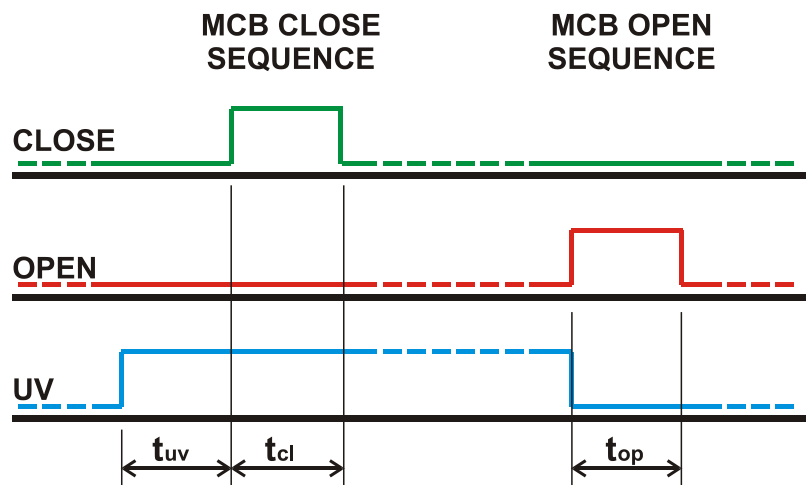

### The MCB CLOSE sequence is below:

Activate UV output, wait for undervoltage coil timer ( $t_{uv}$ )

Activate CLOSE output, wait for close pulse timer ( $t_{cl}$ )

Deactivate CLOSE output

### The MCB OPEN sequence is below:

Deactivate UV output

Activate OPEN output, wait for open pulse timer ( $t_{op}$ )

Deactivate OPEN output



**Open Pulse, Close Pulse and Undervoltage Coil timers are adjusted through programming menu.**



**If MCB feedback input is defined and the MCB fails to change position after the expiration of MCB Fail timer, then a fault condition will occur.**

MCB modules can be operated by 2 different ways. The unit supports both configurations.

Below is the terminology used:

**M**: gear motor

**PF**: ready to close contact

**XF**: close coil

**MX**: open coil

**MN**: undervoltage trip (release)

**AUX**: auxiliary contacts

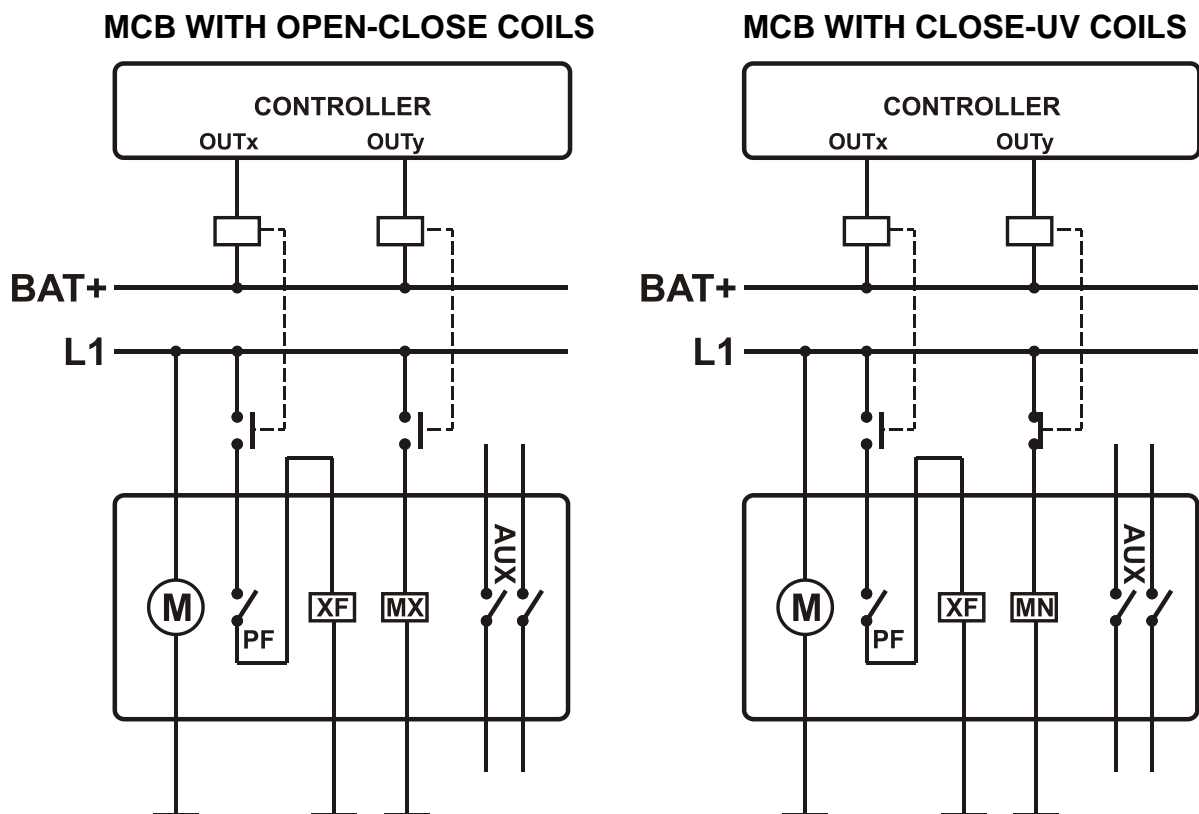

**In the diagram at left, relay function assignments should be as below:**

**OUTx**: Mains (or Genset) Close Pulse

**OUTy**: Mains (or Genset) Open Pulse

**In the diagram at right, relay function assignments should be as below:**

**OUTx**: Mains (or Genset) Close Pulse

**OUTy**: Mains (or Genset) Undervoltage Coil

## 20. J1939 CANBUS ENGINE SUPPORT

The unit offers a special J1939 port in order to communicate with electronic engines controlled by an **ECU** (electronic control unit). The J1939 port consists of 2 terminals which are **J1939+** and **J1939-**.

The connection between the unit and the engine should be made with an appropriate balanced 120 ohms low capacitance coaxial cable. The external conductor should be grounded at one end only.

A **120 ohms** termination resistor is installed inside the unit. Please do not connect external resistor.

The J1939 port is activated by setting the program parameter **J1939 Enable** to **1**. The **J1939 Engine Type** parameter should be set accordingly. The list of available engines is given at the programming section. Please contact DATAKOM for the most current list of engines.

If the J1939 port is enabled then the **oil pressure**, **coolant temperature** and the **engine rpm** information are picked up from the **ECU** unit. If connected, the MPU unit and related analog senders are discarded.

The controller is able to read and display all below parameters, under condition that the engine sends these information. Most engines send only some of them. If the engine does not send a parameter, the unit will simply skip it. Thus only available information are displayed.

### The complete list of J1939 display parameters is below:

PGN 65253 / SPN 247 Engine Total Hours of Operation  
 PGN 65257 / SPN 250 Engine Total Fuel Used  
 PGN 65262 / SPN 110 Engine Coolant Temperature  
     / SPN 174 Engine Fuel Temperature 1  
     / SPN 175 Engine Oil Temperature 1  
 PGN 65263 / SPN 100 Engine Oil Pressure  
     / SPN 94 Engine Fuel Delivery Pressure  
     / SPN 98 Engine Oil Level  
     / SPN 101 Engine Crankcase Pressure  
     / SPN 109 Engine Coolant Pressure  
     / SPN 111 Engine Coolant Level  
 PGN 65266 / SPN 183 Engine Fuel Rate  
     / SPN 184 Engine Instantaneous Fuel Economy  
     / SPN 185 Engine Average Fuel Economy  
 PGN 65269 / SPN 108 Barometric Pressure  
     / SPN 171 Ambient Air Temperature  
     / SPN 172 Engine Air Inlet Temperature  
 PGN 65270 / SPN 102 Engine Turbocharger Boost Pressure  
     / SPN 105 Engine Intake Manifold 1 Temperature  
     / SPN 106 Engine Air Inlet Pressure  
     / SPN 107 Engine Air Filter 1 Differential Pressure  
     / SPN 173 Engine Exhaust Gas Temperature  
 PGN 65271 / SPN 158  
 PGN 61443 / SPN 92 Engine Percent Load At Current Speed  
     / SPN 91 Accelerator Pedal Position 1  
 PGN 61444 / SPN 190 Engine Speed  
     / SPN 513 Actual Engine - Percent Torque  
     / SPN 512 Driver's Demand Engine - Percent Torque

The J1939 measurements are also available for Modbus operation. Please check chapter **Modbus Communications** for more details.

When the fuel output is active, if no information is received from the ECU during last 3 seconds, then the unit will give a **ECU FAIL** alarm and stop the engine. This feature prevents uncontrolled engine operation.

The **fault conditions of an electronic engine** are considered by the unit as **warnings** and do not cause engine stop. The engine is supposed protected by the ECU which will stop it when necessary.

The electronic engine **fault codes** are displayed **in text** within the alarm list table, together with their **SPN-FMI** codes. The complete list of fault codes is given in the engine manufacturer's user manual.

Below is a basic list of fault conditions (x denotes any FMI)

SPN	FMI	DESCRIPTION
56	x	Overspeed shutdown
57	x	Low oil pressure shutdown
58	x	High engine temp. shutdown
71	x	Gain adjust potentiometer fault
75	x	Generator speed circuit fault
79	x	Frequency adjust potentiometer fault
80	x	Droop adjust potentiometer fault
81	x	Low oil pressure warning
82	x	High engine temp. warning
91	x	Accelerator pedal circuit fault
94	x	Fuel filter restriction Fuel pressure sensor fail
97	x	Water in Fuel
99	x	Oil filter differential pressure fault
98	x	Low oil level, High oil level, Oil level sensor fail
100	x	Low oil pressure, Oil pressure sensor fail
101	x	Crankcase pressure fault
102	x	Intake manifold 1 pressure fault
103	x	Turbocharger 1 speed fault
105	x	Intake manifold temp high, Intake manifold temp sensor fail
106	x	High boost pressure, Turbo outlet pressure sensor fail
107	x	Air filter restriction, Air filter sensor fail
108	x	Atmospheric pressure sensor fail
109	x	Coolant pressure fault
110	x	High coolant temperature, Coolant temperature sensor fail
111	x	Low coolant level, Coolant level sensor fail
153	x	Crankcase ventilation fault
158	x	Battery voltage failure
164	x	High injector activation pressure, Injector activation pressure sensor fail
168	x	Battery 1 voltage fault
172	x	High inlet air temperature, High inlet manifold air temperature, Inlet manifold air temperature sensor fail
173	x	Exhaust gas temp. fault
174	x	High fuel temperature, Fuel temperature sensor fail
175	x	High oil temperature, Oil temperature sensor fail
190	x	Overspeed, Speed sensor loss of signal, Speed sensor mechanical failure

SPN	FMI	DESCRIPTION
234	x	Incorrect ECM software
612	x	Engine magnetic speed sensor fault
620	x	ECU internal +5V fail
626	x	Preheating relay fault
627	x	Injector power supply fault
629	x	ECU hardware fail
630	x	ECU memory fail
633	x	Fuel injector valve fault
636	x	Camshaft sensor
637	x	Flywheel sensor
639	x	ECU memory fail
644	x	External speed comm. Input fault
647	x	Fan control circuit fault
651	x	Injector cylinder #1 fault
652	x	Injector cylinder #2 fault
653	x	Injector cylinder #3 fault
654	x	Injector cylinder #4 fault
655	x	Injector cylinder #5 fault
656	x	Injector cylinder #6 fault
657	x	Injector cylinder #7 fault
657	x	Injector cylinder #8 fault
677	x	Start motor relay fail
723	x	Secondary engine speed sensor fail
1075	x	Electric lift pump circulation fault
1079	x	ECU internal +5V fail
1111	x	Check configuration parameters
1265	x	Engine oil burn valve fault
1377	x	Multiple unit synch. Switch fault
1378	x	Engine oil change interval
1384	x	Engine commanded shutdown
2000	x	ECU failure
2433	x	Exhaust gas temp. right manifold
2434	x	Exhaust gas temp. left manifold
2791	x	Internal EGR fail



Below is a basic list of FMI codes.

Please be aware that these codes may differ slightly depending on the engine brand and model.

<b>FMI</b>	<b>DESCRIPTION</b>
0	Value too high" Valid data, but above the normal working range
1	"Value too low" Valid data, but below the normal working range
2	"Faulty data" Intermittent or faulty data or Short circuit to battery voltage, injector high voltage side
3	"Electrical fault" Abnormally high voltage or short circuit to battery voltage, injector low voltage side
4	"Electrical fault" Abnormally low voltage or short circuit to battery negative, injector low voltage or high voltage side
5	"Electrical fault" Abnormally low current or open circuit
6	"Electrical fault" Abnormally high current or short circuit to battery negative
7	"Mechanical fault" Faulty response from mechanical system
8	"Mechanical or electrical fault" Abnormal frequency
9	"Communication fault" Abnormal updating rate or Open circuit in injector circuit
10	"Mechanical or electrical fault" Abnormally large variations
11	"Unknown fault" Unidentified fault
12	"Component fault" Faulty unit or component
13	"Faulty calibration" Calibration values outside the limits
14	"Unknown fault" Special instructions
15	Data valid but above normal operating range - least severe level
16	Data valid but above normal operating range - moderately severe level
17	Data valid but below normal operating range - least severe level
18	Data valid but below normal operating range - moderately severe level
19	Received network data in error
20	not used (reserved)
21	not used (reserved)
22	not used (reserved)
23	not used (reserved)
24	not used (reserved)
25	not used (reserved)
26	not used (reserved)
27	not used (reserved)
28	not used (reserved)
29	not used (reserved)
30	not used (reserved)
31	Condition exist

## 21. GPS SUPPORT

The unit supports external GPS modules from RS-232 port.

RS-232 GPS modules are available at Datakom.



**DATAKOM RS-232 GPS MODULE**

Related parameters are:

Parameter Definition	Unit	Min	Max	Factory Set	Description
Modem / GPS Selection	-	0	5	0	0: no modem 1: Internal GSM modem 2: external Datakom modem 3: external generic modem 4: no modem, GPS on RS-232 5: Internal modem, GPS on RS-232
External Modem / GPS Baud Rate	bps	2400	57600	57600	This is the data rate of the RS-232 port for the external modem / GPS.

The GPS screen is found under GSM Modem screen group.



**GPS SCREEN**

The GPS location determination is based on signals transmitted by GPS satellites circulating in earth's orbit. 24 satellites are available in total, but the number of satellites in sight will depend on the physical location and time.

A minimum of 3 satellites are necessary to determine the location. A fourth satellite is used for verification. More satellites will mean more precision. The unit displays the number of effective satellites on its GPS screen.

GPS satellites transmit a precision date and time information as well. This information is displayed on the GPS Screen, but not used elsewhere.

The location determination quality of the GPS module will depend on the physical location. The GPS should be installed in a location where it is capable of seeing a large portion of open sky. It can also work on reflections from ground or other buildings without seeing the sky, but location precision will be affected by this.



**GPS based location has priority over GSM based location. If both type of locations are available, then GPS location will be used.**

Geographical location is stored in a non-volatile memory once an hour. Thus if the GPS signal is lost, the unit continues to appear at the same location of the remote monitoring system. However a GPS warning will be generated on loss of signal or communication with the module.

It is possible to program the geographical location inside the controller, forcing it to appear at the desired location of the remote monitoring system. The location setting is done through Rainbow Plus only.

Location parameters are found under: **Communication>Basic** tab

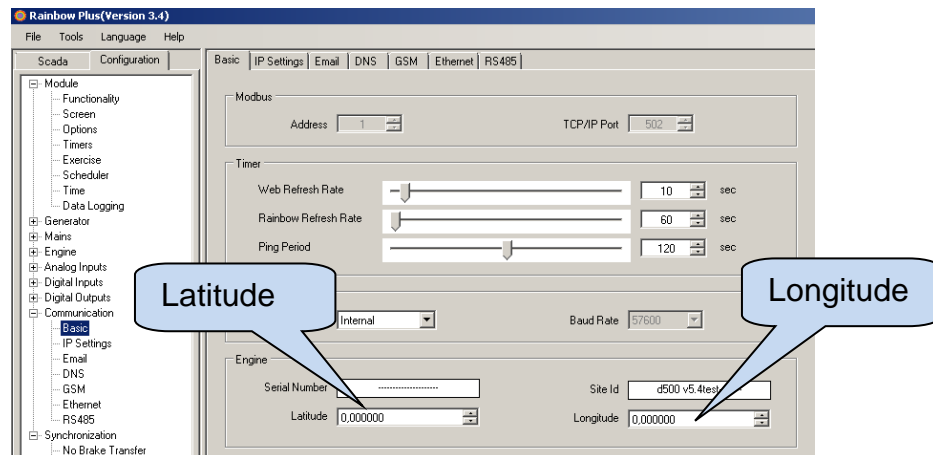

## 22. GSM CONFIGURATION

Please see related document: **GSM Configuration Guide for D-500 D-700.**

## 23. CENTRAL MONITORING OF GENSETS

Please see related document: **Rainbow Scada Usage Guide.**

## 24. E-MAIL SENDING

Please see related document: **Ethernet Configuration Guide for D-500 D-700.**

## 25. SMS COMMANDS



SMS messages are accepted only from phone numbers recorded in the **Communication>GSM>Message Numbers** tab.

Answers to SMS messages will be sent to all phone numbers in the list.



SMS messages must be written exactly as below, without any preceding blanks. Only **UPPERCASE** characters are permitted.

COMMAND	DESCRIPTION	ANSWER
<b>GET IP</b>	If GPRS connection is active, the controller will reply by an SMS message indicating the IP address of the GSM modem.	<b>IP: 188.41.10.244</b>
<b>GPRS 1</b>	Activates the GPRS connection	<b>GPRS enabled!</b>
<b>GPRS 0</b>	Stops the GPRS connection	<b>GPRS disabled!</b>
<b>RESET ALARMS</b>	Clears alarms of the controller. The operating mode is not modified.	<b>Alarms cleared!</b>
<b>REBOOT</b>	Performs a hard reset on the controller	no answer
<b>MODEM RESET</b>	Performs a hard reset on the modem	no answer
<b>GET INFO</b>	Returns the alarm list and actual measured values	<b>ALARMS (if exists)</b> <b>GEN: Vavg/I<sub>AVG</sub>/kWtot/pf/Freq</b> <b>MAINS: Vavg/I<sub>AVG</sub>/kWtot</b> <b>OIL_PR/TEMP/FUEL%</b>

COMMAND	DESCRIPTION	ANSWER
<b>MODE STOP</b>	Puts the controller into STOP mode. Alarms are also cleared.	<b>Unit forced to STOP!</b>
<b>MODE AUTO</b>	Puts the controller into AUTO mode. Alarms are also cleared.	<b>Unit forced to AUTO!</b>
<b>MODE MANUAL</b>	Puts the controller into MANUAL (RUN) mode. Alarms are also cleared.	<b>Unit forced to RUN!</b>
<b>MODE TEST</b>	Puts the controller into TEST mode. Alarms are also cleared.	<b>Unit forced to TEST!</b>
<b>OUT1 ON</b>	Sets remote controlled output #1 to active state	<b>OUT 1 = ON</b>
<b>OUT1 OFF</b>	Sets remote controlled output #1 to passive state	<b>OUT 1 = OFF</b>
<b>OUTxx ON</b>	Sets remote controlled output #xx to active state (xx denotes any number between 1 and 16).	<b>OUT xx = ON</b>
<b>OUTxx OFF</b>	Sets remote controlled output #xx to passive state (xx denotes any number between 1 and 16).	<b>OUT xx = OFF</b>

## 26. SOFTWARE FEATURES

### 26.1. LOAD SHEDDING / DUMMY LOAD

The load shedding feature consists on the disconnection of the least crucial loads when the genset power approaches to its limits. These loads will be supplied again when the genset power falls below the programmed limit. The internal Load Shedding function is always active. Any digital output may be used as the load shedding output.

The dummy load function consists on the connection of a dummy load if the total genset load is below a limit and to disconnection of the dummy load when the total power exceeds another limit. The dummy load function is the inverse of the load shedding function, thus the same output may be used for both purposes.

It is also possible to control more complex external systems with multiple steps, using LOAD\_ADD and LOAD\_SUBSTRACT output functions. Any digital output may be assigned to these signals.

When the load is above the Load Shedding High Limit, the controller will activate the Load Shedding output.

When the load is below the Load Shedding Low Limit, the controller will release the Load Shedding output.

The parameters used in Load Shedding feature are in the Electrical Parameters Group:

**Load Shedding Low Limit:** If the genset power goes below this limit then the load shedding relay will be deactivated.

**Load Shedding High Limit:** If the genset power goes above this limit then the load shedding relay will be activated.

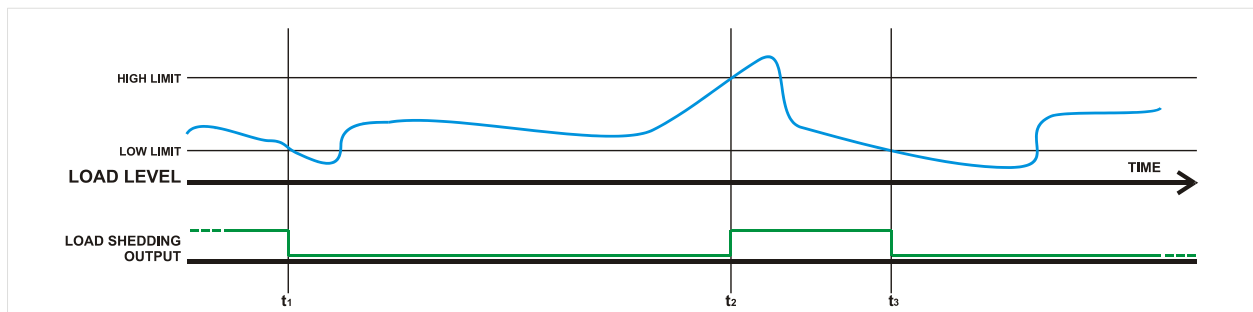

**t<sub>1</sub>:** the load goes below the Load Shedding Low Limit, thus the Load Shedding output becomes inactive.

**t<sub>2</sub>:** the load goes above the Load Shedding High Limit, thus the Load Shedding output becomes active.

**t<sub>3</sub>:** the load goes below the Load Shedding Low Limit, thus the Load Shedding output becomes inactive.

## 26.2. LOAD ADD / SUBSTRACT

The load add/subtract output functions are designed to provide control signals for an external, multi-step load adding/subtracting system.

This external system will add either linearly or by small steps a dummy load that will prevent the genset from running below the minimum required load level.

The same function may be used in order to supply loads of different priority levels following the available genset capacity.

When the load is below the Load Shedding Low Limit, the controller will activate the Load Add output. The external system will increase the load until it goes over the low limit, where the Load Add output will become inactive.

When the load is above the Load Shedding High Limit, the controller will activate the Load Subtract output. The external system will decrease the load until it goes below the high limit, where the Load Subtract output will become inactive.

There are protection delays between two pulses. These timers help to stabilizing the decision algorithm and preventing unwanted multiple operations.

The parameters used in Load Shedding feature are in the Electrical Parameters Group:

**Load Shedding Low Limit:** If the genset power goes below this limit then the load\_add relay will be active.

**Load Shedding High Limit:** If the genset power goes above this limit then the load\_subtract relay will be active.

**Load Add Delay:** This is the minimum delay between 2 load\_add pulses. This is also the minimum delay between 2 load\_subtract pulses.

**Load Subtract-Add Delay:** This is the minimum delay between load\_add and load\_subtract pulses.

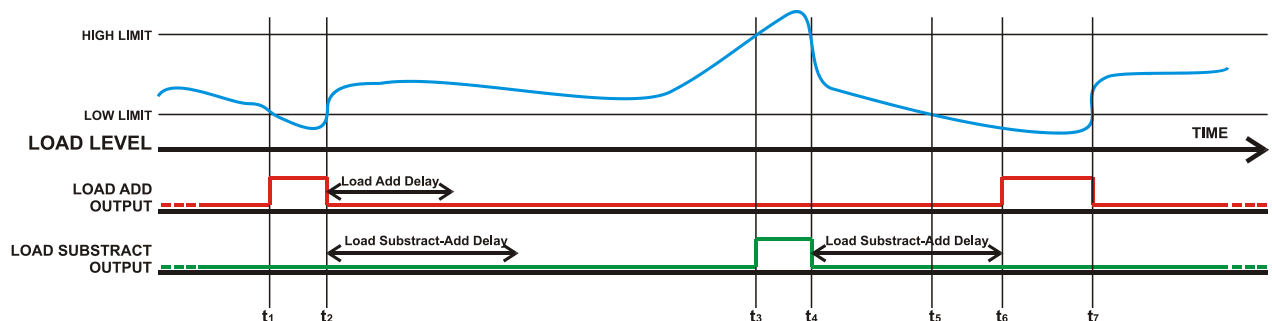

**t1:** the load goes below the Load Shedding Low Limit, thus the Load Add output becomes active.

**t2:** the load goes above the Load Shedding Low Limit, thus the Load Add output becomes inactive.

**t3:** the load goes above the Load Shedding High Limit, thus the Load Subtract output becomes active.

**t4:** the load goes below the Load Shedding High Limit, thus the Load Subtract output becomes inactive.

**t5:** the load goes below the Load Shedding Low Limit, but the Load Subtract-Add delay is not expired. The controller waits until expiration of the timer.

**t6:** the timer is expired and the load is still below the Load Shedding Low Limit, the Load Add output becomes active.

**t7:** the load goes above the Load Shedding Low Limit, thus the Load Add output becomes inactive.



## 26.3. FIVE STEP LOAD MANAGEMENT

The controller is able to manage the supply of up to 5 prioritized loads. The loads are supplied starting from the number #1 (highest priority) and unloaded from the highest number (lowest priority) available.

Protection timers help to stabilizing the decision algorithm and preventing unwanted multiple operations.

When the load is below the **Multi Load Add Power Level** during **Multi Load Add Start Delay**, then 1 step of load is added. The minimum wait period between two load\_adds is **Multi Load Add Wait Delay**.

When the load is above the **Multi Load Subtract Power Level** during **Multi Load Subtract Start Delay**, then 1 step of load is unloaded. The minimum wait period between two load\_subtracts is **Multi Load Subtract Wait Delay**.

Add and subtract outputs send pulses of 0.25s duration.

**The parameters used in Load Shedding feature are in the Electrical Parameters Group:**

**Multi Load Subtract Power Level:** When the genset active power goes over this limit, the controller will start subtracting load.

**Multi Load Add Power Level:** When the genset active power goes below this limit, the controller will start adding load.

**Multi Load Subtract Start Delay (tLSD):** If the load stays over the **Multi Load Subtract Power Level** parameter during this timer, then 1 step of load is subtracted.

**Multi Load Subtract Wait Delay (tLSW):** This is the minimum period between two load subtract pulses.

**Multi Load Add Start Delay (tLAD):** If the load stays below the **Multi Load Add Power Level** parameter during this timer, then 1 step of load is added.

**Multi Load Add Wait Delay (tLAW):** This is the minimum period between two load add pulses.

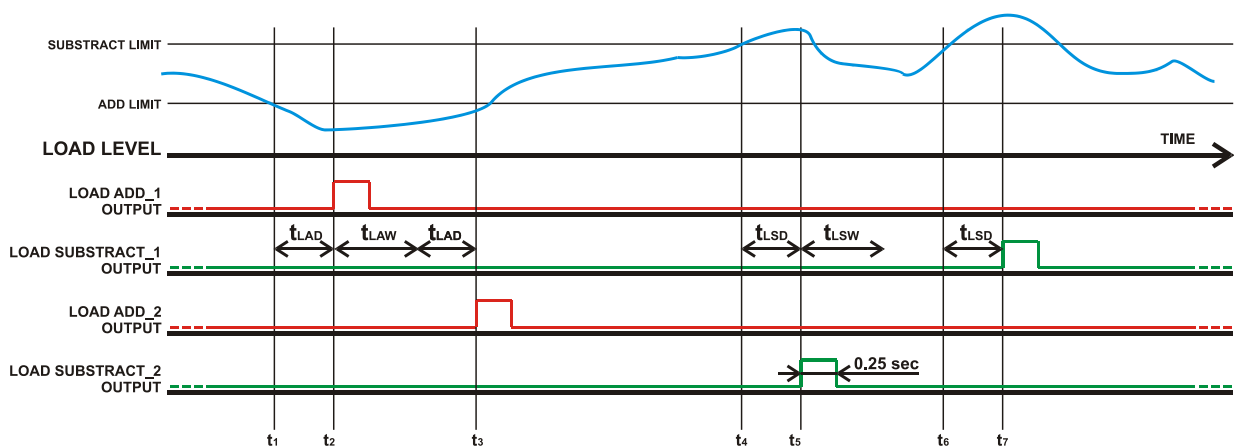

**t1:** the load goes below the Multi Load Add Power Level.

**t2:** after Multi Load Add Start Delay the load is still below Multi Load Add Power Level, the Load\_Add\_1 sends a pulse.

**t3:** after Multi Load Add Start Delay and Multi Load Add Wait Delay, the load is still below Multi Load Add Power Level, thus Load\_Add\_2 output sends a pulse.

**t4:** the load goes above the Multi Load Subtract Power Level.

**t5:** after Multi Load Subtract Start Delay, the load is still above Multi Load Subtract Power Level, thus the Load\_Subtract\_2 sends a pulse.

**t6:** the load goes above the Multi Load Subtract Power Level.

**t7:** Multi Load Subtract Wait Delay is already expired. After Multi Load Subtract Start Delay, the load is still above Multi Load Subtract Power Level, thus the Load\_Subtract\_1 output sends a pulse.

## 26.4. REMOTE START OPERATION

The unit offers the possibility of **Remote Start** mode of operation. Any digital input may be assigned as **Remote Start Input** using **Input Function Select** program parameters.

The **Remote Start** signal may be a NO or NC contact, switching to either battery positive or battery negative. These selections are made using programming menu.

It is also necessary to set the **ACTION** program parameter of the related input to **3** in order to prevent any alarm from this input.

When a **Remote Start** input is defined, the mains phases are not monitored. When the **Remote Start** signal is present then the mains will be supposed to fail, inversely when the **Remote Start** signal is absent then mains voltages will be supposed to be present.

The front panels mimic diagram's mains LEDs will always reflect the status of the **Remote Start** input.

## 26.5. DISABLE AUTO START, SIMULATE MAINS

The unit offers an optional **Disable Auto Start** signal input. Any digital input may be assigned as **Disable Auto Start** using **Input Function Select** program parameters.

It is also necessary to set the **ACTION** program parameter of the related input to **3** in order to prevent any alarms generated from this input.

The **Disable Auto Start** signal may be a NO or NC contact, switching to either battery positive or battery negative. These selections are made using the programming menu.

If the **Disable Auto Start** input is defined and the input signal is active, the mains phases are not monitored and supposed to be inside limits. This will prevent the genset from starting even in case of a mains failure. If the genset is running when the signal is applied, then usual Mains Waiting and Cooldown cycles will be performed before engine stop. When the **Disable Auto Start** signal is present, the front panels mimic diagram's mains LEDs will reflect the mains voltages as present.

When the signal is passive, the unit will revert to normal operation and monitor the mains voltage status.



**The REMOTE START operation overrides DISABLE AUTO START and FORCE TO START operations.**

## 26.6. BATTERY CHARGING OPERATION, DELAYED SIMULATE MAINS

The Delayed Mains Simulation feature is used in battery backed up telecom systems where batteries are able to supply the load during a certain period. The genset is requested to run only when battery voltage drops below the critical level. Once the engine runs, the rectifier system starts charging the batteries and the battery voltage goes up immediately. Thus the engine should continue to run a programmed period for effective charging. The critical battery voltage level will be detected by an external unit which provides the digital **Disable Auto Start** signal for the genset control unit.

The unit offers an optional **Disable Auto Start** signal input. Any digital input may be assigned as **Simulate Mains** using **Input Function Select** program parameters.

It is also necessary to set the **ACTION** program parameter of the related input to **3** in order to prevent any alarms generated from this input.

The **Disable Auto Start** signal may be a NO or NC contact, switching to either battery positive or battery negative. These selections are made using the programming menu.

If the **Delayed Simulate Mains** program parameter is set to 1 and the input signal is active when the genset is not feeding the load, the mains phases are not monitored and supposed to be inside limits. This will prevent the genset from starting when the simulate mains signal is present (batteries charged). The genset will start when mains voltages are out of limits and the simulate mains signal not present.

If the genset is running when the signal is applied, then MAINS SIMULATION will be prevented during **Flashing Relay On Timer** program parameter. After this, usual Mains Waiting and Cooldown cycles will be performed before engine stop. When the SIMULATE MAINS signal is present, the front panels mimic diagram's mains LEDs will reflect the mains voltages as present.

When the signal is passive, the unit will revert to normal operation and monitor the mains voltage status.



**The REMOTE START operation overrides Disable Auto Start operation. When both “Remote Start Operation” and “Delayed Simulate Mains” are enabled then REMOTE START operation mode is performed.**

## 26.7. DUAL GENSET MUTUAL STANDBY OPERATION

Dual genset intermittent operation consists of regular switching of the load between 2 gensets. The use of 2 gensets instead of one is due either to safety purposes in case of a genset failure or to a continuous operation requesting service stops.

The running period for each genset is adjustable using **Flashing Relay On Timer** and **Flashing Relay Off Timer** program parameters. If the time is adjusted as 0 hours, it will be actually set to 2 minutes for faster testing purposes.

A flashing relay output function is provided, based on the parameter **Flashing Relay On/Off Timers**. Each time the period programmed using **Flashing Relay Timer** elapses, the relay output will change position.

The flashing relay function may be assigned to any digital output using **Output Configuration** program parameters.

The dual genset intermittent operation uses also the **Disable Auto Start** feature. Please review related chapter for a detailed explanation of this feature.

### Priority In Dual Genset Mutual Standby Operation:

It may be required that the dual genset system starts the same genset at every mains failure. This is achieved using the PRIORITY input.

Any digital input may be assigned as **Priority** using **Input Function Select** program parameters.

It is also necessary to set the **ACTION** program parameter of the related input to **3** in order to prevent any alarms generated from this input.

The **Priority** signal may be a NO or NC contact, switching to either battery positive or battery negative. These selections are made using the programming menu.

If a **Priority** input is defined, then the system will work in priority mode. If the priority signal is applied, the unit will become master after each mains failure. If the priority signal is not applied, then the unit will become the slave one and the other genset will start.



**Please contact DATAKOM for a complete application manual.**

## 26.8. MULTIPLE VOLTAGE AND FREQUENCY

The unit offers 3 sets of voltage and frequency protection limit values. The user is allowed to switch between these 3 sets anytime.

This feature is especially useful in multiple voltage or frequency gensets for easy switching between different operating conditions.

**The switching to the second or third set of limit values can be done via digital input signal.**

If switching is done with digital input signal, one of digital inputs has to be defined as “**2<sup>nd</sup> Volt-Freq Select**” using “**INPUT FUNCTION SELECT**” program group.

If third set is used, the one of digital inputs has to be defined as “**3<sup>rd</sup> Volt-Freq Select**” using “**INPUT FUNCTION SELECT**” program group.

**Below parameters are available for second voltage-frequency selection:**

Nominal Voltage

Nominal Frequency

Nominal RPM

Genset Overcurrent Limit

## 26.9. SINGLE PHASE OPERATION

If the unit is used in a single phase electrical network, it is advised to select the topology as **Single Phase 2 Wires**.

When the topology is set to **Single Phase 2 Wires**, then the unit will measure electrical parameters only on phases **L1** of genset and mains.

Voltage and overcurrent checks will be performed on phases **L1** only.

Phases **L2** and **L3** parameters, as well as phase-to-phase voltages are removed from display screens.

## 26.10. EXTERNAL CONTROL OF THE UNIT

The unit offers total external control through programmable digital inputs. Any digital input may be programmed for below functions:

- Force STOP mode
- Force AUTO mode
- Force TEST mode
- Disable Auto Start
- Force to Start
- Fault Reset
- Alarm Mute
- Panel Lock

External mode select signals have priority on mode buttons of the unit. If the mode is selected by external signal, it is impossible to change this mode with front panel pushbuttons. However if the external mode select signal is removed, the unit will revert to the last selected mode via pushbuttons.

It is also possible to lock the front panel completely for remote command.

## 26.11. AUTOMATIC EXERCISER

The unit offers 7 independent automatic exercisers. The exercise operation may be done on a weekly or monthly basis.

The start day and time of the exercise is programmable as well as its duration. The exercise may be done with or without load following programming.

**Program parameters related to the exerciser are:**

Exercise start day and hour

Exercise duration

Exercise off\_load/on\_load

Please refer to the programming section for a more detailed description of the above parameters.

When the start day and hour of exercise has come, the unit will automatically switch to either **RUN** or **TEST** mode. The engine will run. If the on\_load exercise is selected then the load will be transferred to the genset.

If a mains failure occurs during the off-load exercise, the load will not be transferred to the genset unless the **Emergency Backup Operation** is allowed by setting the related program parameter to 1. Thus it is highly recommended that the Emergency Backup mode enabled with off-load exerciser.

At the end of the exercise duration, the unit will switch back to the initial mode of operation.

If any of the mode selection keys are pressed during exercise, then the exercise will be immediately terminated.

Using the weekly exercise mode and with suitable parameter setting, the unit may feed the load from the genset during predefined hours of each day. This operation may be used in high tariff periods of the day.

## 26.12. WEEKLY OPERATION SCHEDULER

In most applications, the genset is requested to operate only in working hours. Thanks to the weekly program feature, unwanted operation of the genset may be prohibited.

The scheduler is active only in **AUTO** mode. When the scheduler prevents genset operation in AUTO mode, the **AUTO** led will flash.



**When the scheduler prevents genset operation in AUTO mode, the AUTO led will flash.**

The scheduler consists of 144 programmable parameters, one for each hour in a week. Thus every hour of the week may be independently selected as ON or OFF times.

These programmable parameters allow the genset to operate automatically only in allowed time limits.

The unit has a battery backed-up precision real time clock circuit. The real time clock circuit will continue its operation even in power failures. The real time clock is precisely trimmed using the **Real Time Clock Adjust** program parameter. For more details check the programming section.

## 26.13. ENGINE HEATING OPERATION

Especially on engines without a body heater, or with a failing one, it may be desired that the genset should not take the load before reaching a suitable temperature. The unit offers 2 different ways of engine heating.

### 1. Timer controlled heating:

This operation mode is selected when the **Engine Heating Method** parameter is set to **0**. In this mode, the engine will run during parameter **Engine Heating Timer**, and then the genset will take the load.

### 2. Timer and temperature controlled heating:

This operation mode is selected when the **Engine Heating Method** parameter is set to **1**. In this mode, at first the engine will run during parameter **Engine Heating Timer**, then it will continue to run until the measured coolant temperature reaches the limit defined in parameter **Engine Heating Temperature**. When the requested temperature is reached, the load will be transferred to the genset. This operation mode may be used as a backup to the engine body heater. If the engine body is warm the heating will be skipped.

## 26.14. ENGINE IDLE SPEED OPERATION

It may be required that the engine runs at the idle speed for a programmed duration for engine heating. The idle operation duration is adjusted with the parameter **Idle Speed Timer**. The idle speed will be set by the governor control unit of the engine.

Any digital output may be assigned as **IDLE output** using **Relay Definition** program parameters.

The Idle speed operation is performed both in engine start-up and cool-down sequences. Low speed and low voltage protections are disabled during idle speed operation.

## 26.15. ENGINE BLOCK HEATER

The unit is able to provide a digital output in order to drive the block heater resistor. The temperature reference is the coolant temperature measured from the analog sender input.

The block heater output function may be assigned to any digital output using **Relay Definition** program parameters.

The engine body temperature limit is adjusted using the parameter **Engine Heating Temperature**. The same parameter is used for engine heating operation.

The relay will become active if the body temperature falls to 4 degrees below the limit set by **Engine Heating Temperature**. It turns off when the body temperature exceeds **Engine Heating Temperature**.

## 26.16. FUEL PUMP CONTROL

The unit is able to provide a digital output function in order to drive the fuel pump motor.

The fuel pump is used to transfer fuel from the large capacity main tank (if exists), to the genset daily tank which is generally integrated in the chassis and has a limited capacity.

The fuel level reference is measured through the analog fuel level sender. When the measured fuel level falls below **Fuel Pump Low Limit** parameter, the fuel pump output function will become active. When the fuel level reaches **Fuel Pump High Limit** parameter, the output function will become passive. Thus the chassis fuel tank level will be always kept between **Fuel Pump Low Limit** and **Fuel Pump High Limit** parameters.

If the **Fuel Pump High** Limit is not reached within **Fuel Filling Timer** duration, then the fuel pump will stop for safety.

The fuel pump relay function may be assigned to any digital output using **Relay Definition** program parameters.

## 26.17. GAS ENGINE FUEL SOLENOID CONTROL

The unit provides a special function for the fuel solenoid control of a gas engine.

The fuel solenoid of a gas engine is different from a diesel engine. It should be opened after the cranking has been started and should be closed between crank cycles. The delay between the crank start and solenoid opening is adjusted using the **Gas Solenoid Delay** program parameter.

The gas engine fuel solenoid relay function may be assigned to any digital output using **Relay Definition** program parameters.

## 26.18. PRE-TRANSFER SIGNAL

The controller is able to provide a pre-transfer digital output function.

This function is designed for elevator systems, in order to bring the cabin to a floor and open cabin doors before transfer.

The duration where this output is active is adjusted with the **Pre-Transfer Delay** parameter.



**If the Pre-transfer Delay parameter is not zero, this will delay transfers by the same amount.**



## 26.19. CHARGING THE ENGINE BATTERY

The controller offers an automatic charge cycle for the engine battery.

When the engine battery weakens, the genset will run automatically during programmed period in an unloaded state in order to charge the engine battery, protecting it from total discharge when the genset has not run for a long time.

### **Related parameters:**

**Battery Charge Run Voltage:** If this parameter is different from zero and the engine battery voltage falls below this limit then the controller will run the engine unloaded, in order to charge engine battery. The running duration is determined by the **Battery Charge Run Timer** parameter.

**Battery Charge Run Timer:** This parameter determines the engine battery charge running duration. The minimum run time is 2 minutes.

**Emergency Backup:** If this parameter is activated and the mains fails during engine battery charging run, then the genset will take the load.

## 26.20. EXTERNALLY CONTROLLED DIGITAL OUTPUTS

The controller offers 16 externally controllable digital output functions.

These output functions have no effect in the operation of the unit; however they can be redirected to any digital output, allowing remote control of functions or external devices.

The remote control of these outputs are enabled through Modbus, Modbus TCP/IP and Rainbow Scada remote control functions.

The outputs are in 16 bits of the same Modbus register, placed at address 11559d.



**Output statuses are kept in a non-volatile memory and are not affected by power failures.**



**Please review the Modbus manual for more details.**

## 26.21. COMBAT MODE

The controller offers a combat mode input function.

When a digital input is defined as Combat Mode and signal applied to this input, the controller will turn off all led lamps and the backlight illumination 10 seconds after any key is pressed.

When a button is pressed, the illumination will be enabled for 10 seconds.

## 26.22. RESETTING THE CONTROLLER

When necessary, the controller may be manually reset by holding the STOP button pressed for 30 seconds.

The manual reset will cause the hardware to be configured following new settings.

It is advised to proceed to a manual reset or power off/on cycle after every hardware configuration modification.

## 26.23. AUTOMATIC CONNECTION TOPOLOGY DETERMINATION

The controller offers the capability of automatically determining the connection topology and setting the voltage checks in accordance.

**Related parameters are:**

Automatic Topology Detection	-	0	1	0	If this parameter is enabled, when the engine runs, the controller will detect the connection topology automatically and will select alarm levels accordingly. <b>0:</b> auto detect not enabled <b>1:</b> auto detect enabled
------------------------------	---	---	---	---	--

If the automatic topology determination is activated by program parameter, when the engine runs, the connection topology is tested to be one of below ones during “holdoff timer” period.

If below voltage conditions are met continuously during 3 seconds, then the topology is considered to be determined.

If the topology cannot be determined during holdoff timer duration, then an “**Unknown Topology**” load dump is generated, and the engine stops after cooldown.



**During topology determination phase, if the RUN button is held pressed, the holdoff timer will not expire and the controller will try to determine the topology as long as the RUN button is held pressed.**

This feature is especially useful for manual voltage adjustment after a new topology selection.

**Available topologies to be determined are:**

TOPOLOGY	Voltage	Overcurrent Limit	Overload Limit
High Wye	314V > L1&L2&L3 > 182V	Overcurrent limit x1	Overload limit x 1
Low Wye	157 V > L1&L2&L3 > 92 V	Overcurrent limit x2	Overload limit x 1
High Zigzag	276 V > L1&L2 > 204 V	Overcurrent limit x1	Overload limit x 2/3
Low Zigzag	136 V > L1&L2 > 84 V	Overcurrent limit x2	Overload limit x 2/3

## 32.24. ZERO POWER AT REST

In a manual genset, it is possible to reduce the current consumption of the unit down to true zero Amperes, in order to prevent the battery from discharging.

For “zero power at rest operation”, an external relay and “wake-up” pushbutton is necessary.

A digital output should be set to ZERO POWER RELAY function. An external relay should be driven with this digital output. The relay contact will feed the controller power supply.

Any digital output may be assigned as zero-power-relay output. Please refer to the relay function list for the setup.

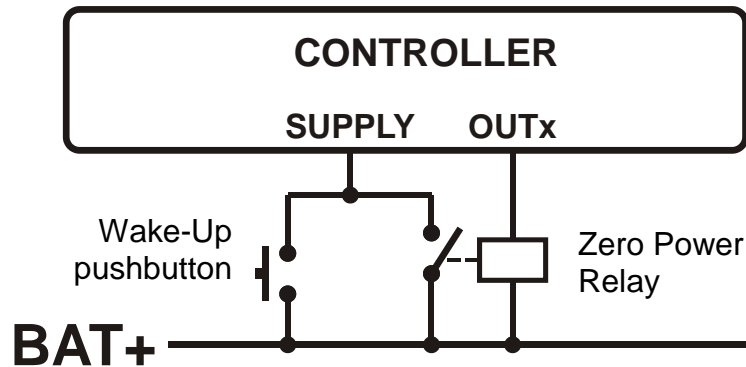

The controller wakes-up on applying the power through the “wake-up” pushbutton. Then it will immediately activate the zero power output which will cause the zero power relay to feed the controller.

If the engine is not run, or if the engine stops, a timer of 5 minutes will be counted. At the expiration of the counter, the controller will deenergize the zero power relay which will cut the power supply. The controller will wait in a zero-power state until the wake-up pushbutton is depressed again.

## 27. MODBUS COMMUNICATIONS



**This chapter is a brief description of the Modbus properties of the controller. For a complete documentation please use “D-500 D-700 Modbus Application Manual”**

The unit offers the possibility of MODBUS communication through below carriers:

- RS485 serial port, with adjustable baud rate between 2400 and 57600 bauds
- MODBUS-TCP/IP through Ethernet port (10/100Mb)
- MODBUS-TCP/IP through GPRS (85/42kb), client mode through Rainbow Scada only

The MODBUS properties of the unit are:

- Data transfer mode: RTU
- Serial data: selectable baud rate, 8 bit data, no parity, 1 bit stop
- Modbus-TCP/IP: Ethernet 10/100Mb or GPRS Class 10.
- Supported functions:
  - Function 3 (Read multiple registers)
  - Function 6 (Write single register)
  - Function 16 (Write multiple registers)

Each register consists of 2 bytes (16 bits). A larger data structure will contain multiple registers.

The Modbus communications requires a slave address to be assigned to each device in the Modbus network. This address ranges between 1 and 240 and allows the addressing of different slave devices in the same network.



**Each device in the same RS-485 serial network must be assigned a different slave address. Otherwise the Modbus communications will not be performed.**



**Devices using Modbus-TCP/IP with different IP or port addresses may use any slave address. It is advised to set these slave addresses to the default setting which is 1.**

## 27.1. PARAMETERS REQUIRED FOR RS-485 MODBUS OPERATION

**Modbus Slave Address:** may be set between 1 and 240

**RS-485 Enable:** must be set to 1 (or checkbox enabled)

**RS-485 Baud Rate:** selectable between 2400 and 57600 bauds. All devices in the same network must use the same Baud Rate.

The complete RS-485 port specifications are found in the **D-500/700 User Manual**.

Selecting a higher baud rate will allow faster communication, but will reduce the communication distance. Selecting a lower baud rate will increase the communication distance, but will cause slower response times.

Typically 9600 bauds will allow 1200m distance with special balanced 120 ohms cable.

## 27.2. DATA FORMATS

**16bit variables:** These variables are stored in a single register. Bit\_0 denotes the LSB and bit 15 denotes the MSB.

**32 bit variables:** These variables are stored in 2 consecutive registers. The high order 16 bits are in the first register and the low order 16 bits are in the second register

**Bit arrays:** Arrays larger than 16 bits are stored in multiple registers. The LSB of the first register is bit\_0. The MSB of the first register is bit\_15. The LSB of the second register is bit\_16. The MSB of the second register is bit\_31, and so on.

Below is a shortlist of available Modbus registers. For complete register map please refer to D-500/700 Modbus Application Manual.

ADDRESS (decimal)	R / W	DATA SIZE	COEFF.	DESCRIPTION
8193	W	16bit	x10	Pushbutton simulation BIT 0.Simulate Stop button BIT 1.Simulate Manual button BIT 2.Simulate Auto button BIT 3.Simulate Test button BIT 4.Simulate Run button BIT 5.Simulate GCB button BIT 7.Simulate Menu+ button BIT 8.Simulate Menu- button BIT 9.Simulate Up button BIT10.Simulate Down button BIT14.Button Long pressed BIT15.Button Very Long Pressed
10240	R	32bit	x10	Mains phase L1 voltage
10242	R	32bit	x10	Mains phase L2 voltage
10244	R	32bit	x10	Mains phase L3 voltage
10246	R	32bit	x10	Genset phase L1 voltage
10248	R	32bit	x10	Genset phase L2 voltage
10250	R	32bit	x10	Genset phase L3 voltage
10252	R	32bit	x10	Mains phase L1-L2 voltage
10254	R	32bit	x10	Mains phase L2-L3 voltage
10256	R	32bit	x10	Mains phase L3-L1 voltage
10258	R	32bit	x10	Genset phase L1-L2 voltage
10260	R	32bit	x10	Genset phase L2-L3 voltage
10262	R	32bit	x10	Genset phase L3-L1 voltage
10264	R	32bit	x10	Mains phase L1 current
10266	R	32bit	x10	Mains phase L2 current
10268	R	32bit	x10	Mains phase L3 current
10270	R	32bit	x10	Genset phase L1 current
10272	R	32bit	x10	Genset phase L2 current
10274	R	32bit	x10	Genset phase L3 current
10276	R	32bit	x10	Mains neutral current
10278	R	32bit	x10	Genset neutral current
10292	R	32bit	x10	Mains total active power
10294	R	32bit	x10	Genset total active power
10308	R	32bit	x10	Mains total reactive power
10310	R	32bit	x10	Genset total reactive power
10324	R	32bit	x10	Mains total apparent power
10326	R	32bit	x10	Genset total apparent power
10334	R	16bit	x10	Mains total power factor
10335	R	16bit	x10	Genset total power factor
10338	R	16bit	x100	Mains frequency
10339	R	16bit	x100	Genset frequency
10341	R	16bit	x100	Battery voltage
10361	R	16bit	x10	Oil pressure in bars (multiply by 14.50 to for psi)
10362	R	16bit	x10	Engine temp in °C (multiply by 1.8 then add 32 for °F)
10363	R	16bit	x10	Fuel level in %
10364	R	16bit	x10	Oil temp in °C (multiply by 1.8 then add 32 for °F)
10365	R	16bit	x10	Canopy temp in °C (multiply by 1.8 then add 32 for °F)
10366	R	16bit	x10	Ambient temp in °C (multiply by 1.8 then add 32 for °F)
10376	R	16bit	x1	Engine rpm

ADDRESS (decimal)	R / W	DATA SIZE	COEFF.	DESCRIPTION
10504-10519	R	256bit	-	Shutdown alarm bits. Bit definitions are given at the end of the document.
10520-10535	R	256bit	-	Loaddump alarm bits. Bit definitions are given at the end of the document.
10536-10551	R	256bit	-	Warning alarm bits. Bit definitions are given at the end of the document.
10604	R	16bit	-	Unit operation status 0= genset at rest 1= wait before fuel 2= engine preheat 3= wait oil flash off 4=crank rest 5=cranking 6= engine run idle speed 7= engine heating 8= running off load 9= synchronizing to mains 10= load transfer to genset 11= gen cb activation 12= genset cb timer 13= master genset on load, 14= peak lopping 15= power exporting 16= slave genset on load 17= synchronizing back to mains 18= load transfer to mains 19= mains cb activation 20= mains cb timer 21= stop with cooldown 22= cooling down 23= engine stop idle speed 24= immediate stop 25= engine stopping
10605	R	16bit	-	Unit mode 0= STOP mode 1= AUTO mode 2= MANUAL mode 3= TEST mode
10606	R	16bit	x1	Genset operation timer. In various wait statuses, the genset operation status will change at the expiration of this timer.
10610	R	16bit	-	Device hardware version information
10611	R	16bit	-	Device software version information
10616	R	32bit	x1	Counter: number of genset runs
10618	R	32bit	x1	Counter: number of genset cranks
10620	R	32bit	x1	Counter: number of genset on load
10622	R	32bit	x100	Counter: engine hours run
10624	R	32bit	x100	Counter: engine hours since last service
10626	R	32bit	x100	Counter: engine days since last service
10628	R	32bit	x10	Counter: genset total active energy (kWh)
10630	R	32bit	x10	Counter: genset total inductive reactive energy (kVArh-ind)
10632	R	32bit	x10	Counter: genset total capacitive reactive energy (kVArh-cap)
10634	R	32bit	x100	Counter: remaining engine hours to service-1
10636	R	32bit	x100	Counter: remaining engine days to service-1
10638	R	32bit	x100	Counter: remaining engine hours to service-2
10640	R	32bit	x100	Counter: remaining engine days to service-2
10642	R	32bit	x100	Counter: remaining engine hours to service-3
10644	R	32bit	x100	Counter: remaining engine days to service-3

## 28. DECLARATION OF CONFORMITY

The unit conforms to the EU directives  
-2006/95/EC (low voltage)  
-2004/108/EC (electro-magnetic compatibility)

Norms of reference:

EN 61010 (safety requirements)  
EN 61326 (EMC requirements)

The CE mark indicates that this product complies with the European requirements for safety, health environmental and customer protection.

### **UL / CSA Conformity:**

**UL Compatibility:** UL 6200, Controls for Stationary Engine Driven Assemblies (Certificate Number - 20140725-E314374)

**CSA Compatibility:** CAN/CSA C22.2 No. 14-2005 – Industrial Control Equipment

## 29. MAINTENANCE



**DO NOT OPEN THE UNIT !**

**There are NO serviceable parts inside the unit.**

Wipe the unit, if necessary with a soft damp cloth. Do not use chemical agents

## 30. DISPOSAL OF THE UNIT

Following **DIRECTIVE 2002/96/EC OF THE EUROPEAN PARLIAMENT AND OF THE COUNCIL of 27 January 2003 on waste electrical and electronic equipment (WEEE)**, this unit should be stored and disposed separately from the usual waste.

## 31. ROHS COMPLIANCE

The european ROHS directive restricts and prohibits the use of some chemical materials in electronic devices.

Following the “**DIRECTIVE 2011/65/EU OF THE EUROPEAN PARLIAMENT AND OF THE COUNCIL of 8 June 2011 on the restriction of the use of certain hazardous substances in electrical and electronic equipment**”, this product is listed in annex-I under category: “**Monitoring and control instruments including industrial monitoring and control instruments**” and exempted from ROHS directive.

However Datakom is not using any ROHS uncompliant electronic components in the production. Only the solder contains lead. The switching to unleaded solderin is in progress.



## 32. TROUBLESHOOTING GUIDE



Below is a basic list of most often encountered troubles. More detailed investigation may be required in some cases.

### The genset operates while AC mains are OK or continues to operate after AC mains are OK:

- Check engine body grounding.
- AC mains voltages may be outside programmed limits, measure the phase voltages.
- Check the AC voltage readings on the screen.
- Upper and lower limits of the mains voltages may be too tight. Check the parameters **Mains Voltage Low Limit** and **Mains Voltage High Limit**. Standard values are 170/270 volts.
- The hysteresis voltage may be given to excessive. The standard value is 8 volts.

### AC voltages or frequency displayed on the unit are not correct:

- Check engine body grounding, it is necessary.
- The error margin of the unit is +/- 2 volts.
- If there are faulty measurements only when the engine is running, there may be a faulty charging alternator or voltage regulator on the engine. Disconnect the charging alternator connection of the engine and check if the error is removed.
- If there are faulty measurements only when mains are present, then the battery charger may be failed. Turn off the rectifier fuse and check again.

### KW and cos $\Phi$ readings are faulty although the Amp readings are correct:

- Current transformers are not connected to the correct inputs or some of the CTs are connected with reverse polarity. Determine the correct connections of each individual CT in order to obtain correct KW and cos $\Phi$  for the related phase, and then connect all CTs. Please review chapter "**AC CURRENT INPUTS**"



**Short circuit outputs of unused Current Transformers.**

### When the AC mains fails the unit energizes the fuel solenoid, but does not start and OIL PRESSURE EXISTS ! message is displayed:

- The unit is not supplied with battery (-) voltage at the oil pressure input.
- Oil pressure switch not connected.
- Oil pressure switch connection wire cut.
- Oil pressure switch faulty.
- Oil pressure switch closes too lately. If oil pressure switch closes, the unit will start. Optionally oil pressure switch may be replaced.

**The engine does not run after the first start attempt, then the unit does not start again and OIL PRESSURE EXISTS ! message is displayed:**

-The oil pressure switch closes very lately. As the unit senses an oil pressure, it does not start. When oil pressure switch closes the unit will start. Optionally the oil pressure switch may be replaced.

**When the AC mains fails, the engine starts to run but the unit gives START FAIL alarm and then the engine stops:**

-The generator phase voltages are not connected to the unit. Measure the AC voltage between terminals **GEN L1-L2-L3** and **Generator Neutral** at the rear of the unit while the engine is running. A fuse protecting the generator phases may be failed. A misconnection may be occurred. If everything is OK, turn all the fuses off, and then turn all the fuses on, starting from the DC supply fuse. Then test the unit again.

**The unit is late to remove engine cranking:**

-The generator voltage rises lately. Also the generator remnant voltage is below 15 volts. The unit removes starting with the generator frequency, and needs at least 15 volts to measure the frequency.  
-The unit is also able to cut cranking from charge alternator voltage and oil pressure input. Please read chapter **"CRANK CUTTING"**

**The unit is inoperative:**

Measure the DC-supply voltage between terminals BAT+ and BAT- at the rear of the unit. If OK, turn all fuses off, then turn all the fuses on, starting from the DC supply fuse. Then test the unit again.

**Programming mode can not be entered:**

The program lock input disables programming mode entry. Disconnect the program lock input from battery negative before modification. Do not forget to make this connection again to prevent unauthorized program modifications.

**Some program parameters are skipped:**

These parameters are reserved for factory setting and cannot be modified.

**AUTO led flashes and the genset does not run when mains fail:**

The unit is in Weekly Schedule **OFF** time. Please check date and time setting of the unit. Please check also Weekly Schedule program parameters.

**The genset runs but does not take the load:**

Check that the genset Yellow led is on steadily. Adjust genset voltage and frequency limits if necessary. Check that the digital output-8 is configured as **"Genset Contactor"**  
Check **"Genset Contactor Timer"** program parameter.  
Check that a Genset Loading Inhibit input signal is not active. Check input functions. If an input is configured as **"Genset Loading Inhibit"** then check the signal is not present at this input.